

Primo SD

INSTALLATION Instructions Homogenous Vinyl

03/2018

CONDITIONS AND REQUIREMENTS

- The subfloor must be clean, dry and free from cracks. Dust and contaminants that could prevent adhesion, such as patches of paint, oil, etc., must be removed. Note that asphalt, oil spillage, impregnation agents, pen marks, etc., can cause discoloration. Damp proofing to be carried out according to local building standards. Where required an effective damp proof membrane must be incorporated in the subfloor. Check for dampness in ground supported floors, floors above boiler rooms, floors with underfloor heating or containing high temperature pipework etc.
- Where underfloor heating units are installed in the concrete slab the heating units shall be;
Turned on prior to laying of the floor covering for 3-4 weeks to ensure that the moisture condition of the heated subfloor will permit successful laying of the floor covering. Be turned off 48 h prior to the commencement of installation to allow the subfloor to return to the temperature range recommended by the manufacturer of the floor covering. The heating units shall remain turned off during the laying operations and shall not be turned on again until 6-7 days after the laying is completed in order to allow the adhesive to set.
- **When installing this product on concrete subfloors that do not include damp-proofing, the moisture content measured in terms of relative humidity must not be higher than 85% (in UK and Ireland 75% according to BS 8203). Or less than 2% with CM (Carbide Method)**
- Where pipes are laid in the floor they should be arranged so that the flooring material is not continuously subjected to a temperature above 27°C, otherwise there may be discoloration and/or other alterations of the material
- Extra special care must be taken regarding installations on surfaces where significant temperature changes can be expected, for example, floors exposed to strong sunlight, as adhesion strength and subfloor treatment may be heavily stressed.
- Floor boards and similar substrates should have a moisture content of max 8% (equivalent to 40% RH at +20°C), so that any subsequent movements cannot cause damage.
- **Note: This product are not approved for use in wet areas.**

PREPARATION

- Dust and loose particles must be thoroughly removed. Highly absorbent or variably absorbent substrates should be sealed with suitable primer. The primed surface must be completely dry before laying commences.
- When applying smoothing compounds, use compounds that meet the minimum requirements in the building standards. NOTE: Discolouration can occur when using two-parts polyester compounds if they are mixed incorrectly and/or insufficiently. Do not mix directly on the substrate.
- Use only a lead pencil for marking. Note that any marks made with felt-tipped pens, permanent and non permanent ink markers, ball point pens etc. can cause discoloration due to migration.
- **Pallets of tiles are not allowed to be placed and stored upon each other.**
- If material from several rolls is used, they should have the same manufacturing serial numbers and be used in consecutive order.
- Prior to laying, allow the material, adhesive and subfloor to reach room temperature, i.e. a temperature of at least 18°C. The relative air humidity should be 30-60%. Rolls must be stored indoors at least 24 hours before installation, preferable 48 hours. **Make sure the boxes of tiles are piled not more than five, flat and parallel.**
- The rolls and pallets should be stored on an even surface. Any faults in the material must be reported immediately to your nearest sales office. Always quote the colour, pallet and roll numbers, which are stated on the label.

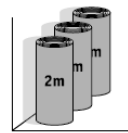

Store 2m rolls upright with distance between the rolls.

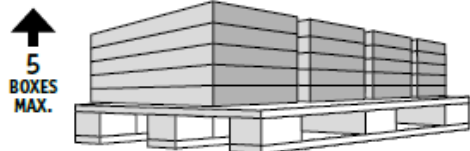

Prior laying make sure tiles are not piled more than five.

INSTALLATION

- If local building standards or regulations states any special installation technique or has technical advises for this type of products not corresponding to this instruction, our instructions are automatically subordinated and should only be taken in consideration as guidelines.
- **Always be careful when cutting, making grooves etc., that the copper strips are not damaged, to ensure that all sections of the surface are connected to earth after installation.**
- **Most commonly, the copper strips will be connected to the normal electrical earthing network of the building. In highly ESD-sensitive areas, the copper strips will be connected to a separate earthing system provided by the end user. In all cases the connection to earth must comply with local electrical and building codes and regulations.**
- Installation should be carried out at room temperature between 18°C to 26°C. Subfloor temperature must be at least 15°C. The relative air humidity in the premises should be 35-65%. Maintain same temperature and humidity for at least 72 hours after installation.
- If material from several boxes is used, they should have the same manufacturing serial numbers and be used in consecutive order. Boxes from different pallets must not be mixed. Pallets shall be installed in sequence.
- If material from several rolls is used, they should have the same manufacturing serial numbers and be used in consecutive order.

INSTALLATION SHEETS

- The earth connection is achieved with the copper strips.
- The sheets are fully adhered with a high quality conductive adhesive with permanent conductive properties, spatula A1/A2. **See the adhesive manufacturer's instruction regarding coverage, open time etc.** Example of suitable adhesives can be found at professionals.tarkett.com

Earth connection sheets:

A copper strip is placed lengthways under each sheet, approx. 200 mm from the edge.
The strips under each sheet are connected with strips across the direction of the sheets at both ends of the area and connected to earth.

- Cut the sheets to length and lay them out to acclimatise and relax prior to installation. This is particularly important for longer lengths.
- The assembly time depends on the type of substrate, its absorbcency, the temperature and air humidity in the premises.
- **Sheets must be installed so that colour differences are avoided. Reverse sheets whenever possible, overlap and cut edges.** Factory edges must be overlapped and cut. Prior to overlapping the vinyl sheet, trim off the factory edge on the bottom sheet. This is best done by striking a chalk line, then – using a utility knife and straight edge – cut through and remove the scrap piece. Overlap the top sheet and then trace the bottom edge onto the top sheet with a correctly set under scriber.
- Rub the face surface down thoroughly to ensure that the floor covering makes good contact with the adhesive and that all air is expelled. Make sure that the tool used for rubbing down the floor covering does not scratch the surface. A broom is not suitable for this purpose. Use a floor roller (approx. 65 kg) and roll crosswise over the floor.

- **On top of the copper strips, apply a high quality conductive adhesive with permanent conductive properties using a brush.**

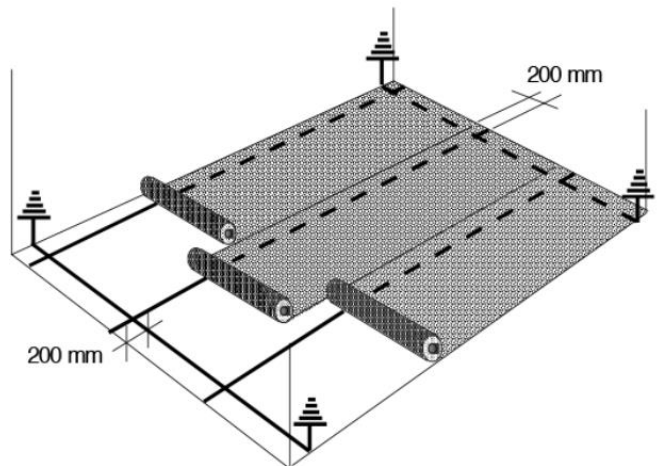

INSTALLATION TILES

- The earth connection is achieved with the copper strips.
- The tiles are fully adhered with a high quality conductive adhesive with permanent conductive properties, spatula A1/A2. **See the adhesive manufacturer's instruction regarding coverage, open time etc.** Example of suitable adhesives can be found at professionals.tarkett.com
- **On top of the copper strips, apply a high quality conductive adhesive with permanent conductive properties using a brush.**
- Tiles could be installed in the same direction or in a checkerboard pattern.

Earth connection tiles:

The strips under each row are connected with strips across the shorter dimension of the room every 10 m and connected to earth. See figure.

- 1/ Tiles Eclipse SD
- 2/ Conductive adhesive
- 3/ Copper strips
- 4/ Earth connection

- Before starting installation, determine the method of laying taking into account the shape of the room and the design to be laid. Installation should start from the middle of the room and be finish along the walls.
- When installing on access flooring systems separate earth connection is not normally required, as this is achieved by the adhesive and the metal construction. Advise concerning conductivity should be taken from the manufacturer of the access flooring system

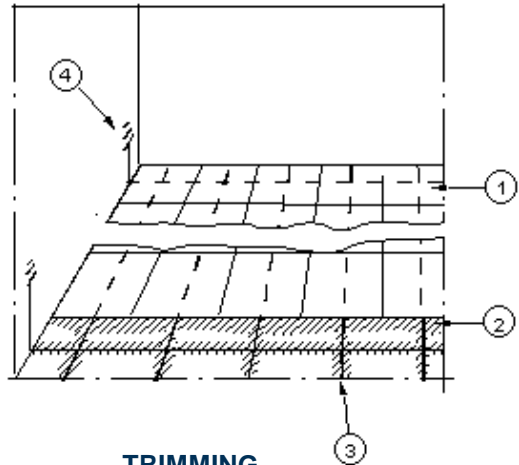

WELDING

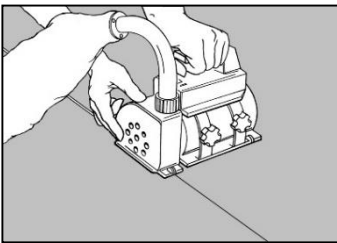

The sheets are hot welded. Do not weld until the adhesive has bonded completely, wait 24-48h. The joints are chamfered or grooved to about 3/4 of the thickness using a hand grooving tool or machine prior to welding.

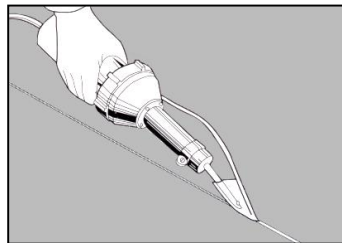

Weld with hot-air and Tarkett Speed Welding Nozzle. Carry out a test welding on a left-over piece before commencing work, to adjust speed and temperature.

TRIMMING

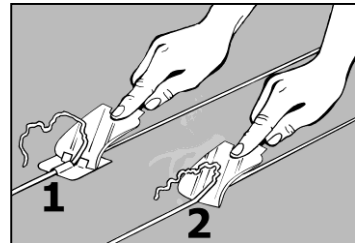

CAUTION: Welded seams must cool to room temperature before trimming. Start trimming where you began welding. All trimming of welding thread is recommended in two steps: rough and fine trimming.

INSPECTION

- The work must be completed with an inspection. Ensure that the newly laid flooring is free from adhesive residues and that the bond is consistent with no bubbles.

AFTER INSTALLATION

- Always protect the floor with thick paper, hard board or similar during the construction period. If using tape, this must not be applied directly to the floor surface.
- **IMPORTANT!** Restrict foot traffic for 24 hours after installation. No heavy traffic, rolling loads or furniture placement for 72 hours after installation. Most suppliers of floor adhesives specify 72 hours before the final strength is achieved."

FOR THE BEST RESULTS

- Use only adhesives recommended by adhesive manufacturer.
- Use a matting system at entrances to protect from dirt and dust. Rubber can cause discoloration to the floor.

GENERAL

- Contact you Tarkett representative if unsure about any part of the installation.
- This information is subject to change continuous improvement

EXCLUSION OF LIABILITY

- Although Tarkett may list a selection of adhesive, levelling compound and surface damp-proof membrane manufacturers and types, we do not guarantee the products listed. The list of products and manufacturers is not guaranteed complete or current. Tarkett will accept no liability for any of these products failing to perform in conjunction with any of its products.

If any doubts or clarifications should be needed, please contact your local Tarkett representative for further information.