

iD Evolution Rigid Collections

MODULAR TILES

Mineral
Acoustic
Solutions

 **Tarkett**

Building new grounds

Step into the next generation of flooring with **iD Evolution Rigid**, our non-PVC Rigid collection. With a composition of **55% mineral content**, it effortlessly blends strength, versatility, and eco-consciousness to deliver an all-in-one flooring solution.

Crafted to last

Tektanium® technology and high resistance to thermal dilation makes it a long-lasting solution for living and working environments.

Designed with performance in mind

Suitable for commercial spaces, offering a **watertight** solution for bathrooms.

Authentic natural designs

Provides an aesthetic appeal that enhance any space with a touch of natural beauty.

iD Evolution Rigid is testament to our commitment to innovative, sustainable design. It offers a robust and stylish modular flooring solution that meets the diverse needs of modern spaces.

LOWER EMISSIONS



Made in Europe with low carbon footprint:
less than 10 kg CO₂ eq/m² (A1-A3)

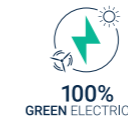

iD Evolution Rigid flooring production uses **100% green electricity**

LESS WASTE



Made from at least **25% recycled content** (post-consumer)



Glue-free installation



Offcuts and post-use

GREATER WELL-BEING



Lowering our environmental footprint will never mean compromising on **comfort, health, or overall well-being**



iD Evolution Rigid is **free of phthalates, halogens, and solvents**



Very low VOC emissions for improved **indoor air quality** (Gold Level)

MORE PROOF



Committed to using the highest quality materials and sharing the impact of our products in a totally transparent way (details listed in our MHS)



Our Product Health Declaration considers the **individual health impacts** of every material within our product



Minerals

iD Evolution Rigid is a high-quality flooring solution **made with 55% mineral** content sourced from two natural resources: chalk and talc.

The New Generation of Modular Flooring:

Natural ingredients for maximum efficiency

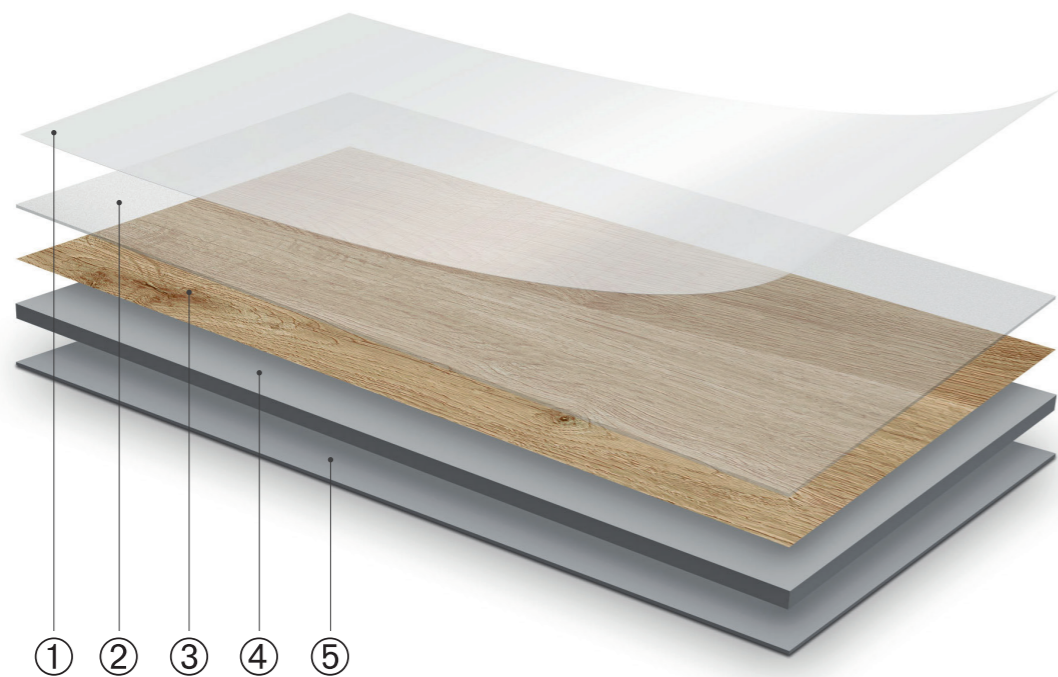

- ① **Top Coat:** imparts a matte finish, providing exceptional scratch resistance.
- ② **Wear Layer:** enhances the texture of the design and significantly bolsters its resistance to wear and tear.
- ③ **Printed Décor:** directly on the board-employs top-quality digital printing techniques to achieve an authentic and natural appearance.
- ④ **Core Layer:** delivers structural strength and durability, while mitigating the transfer effects resulting from surface irregularities.
- ⑤ **Backing Foam:** ensures acoustic properties.

The iD Evolution Rigid collection offers two-click options: the Angle-to-Angle Click for residential purpose or the Push-Down Click for commercial spaces.



Angle-to-Angle Click

iD Evolution Rigid Home offers seamless installation thanks to its Angle-to-Angle Click. This mechanism ensures each plank locks securely into place, creating a gap-free finish that enhances the aesthetic appeal of any room. Angle-to-Angle Click is also renowned for its stability and durability making it a long-lasting floor that can withstand heavy foot traffic.





















Push-Down Click

iD Evolution Rigid brings a new level of convenience and efficiency with the Push-Down Click. This intuitive mechanism, seals planks securely with an angling and push down locking combination, reducing installation time and effort, making it a cost-effective solution for any renovation project. This system ensures a tight, gap-free fit that enhances the overall appearance making the flooring watertight.



ID Evolution Rigid Features

The iD Evolution Rigid collection offers 2 different products, each with its own features. Both products are rigid, durable, practical, easy to clean and install. Take a look at the table below for detailed features.

BENEFITS COLLECTION	 Thickness	 Class of Use	 Acoustic Performance	 Click	 Designs	 Withstands Water	 Dimensional Stability	 Easy to Clean	 Recycled Content	 Can be Installed over Ceramic	 Indoor Air Quality
 iD Evolution Rigid Home	5 mm	 23  31	18 dB	Angle-to-Angle	10	 Waterproof	≤0.10%	✓	> 25%	✓	Gold (≤ 100 µg/m ³)
 iD Evolution Rigid	5,70 mm	 23  34	18 dB	Push-Down	4	 Waterproof & watertight					

Recommended Applications

What product should you use choose for your project according to its technical features?



iD Evolution Rigid Home

Moderate Traffic

Class 23

Class 31



iD Evolution Rigid

High Traffic

Class 34

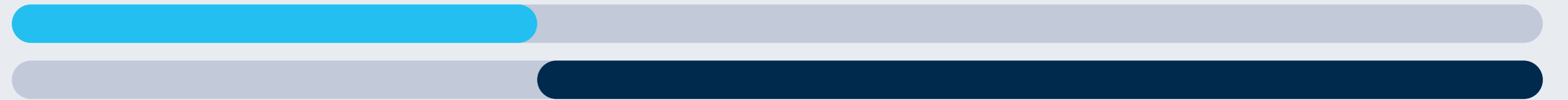

Private Housing

- Durable
- Cost effective
- Easy renovation
- Glue-free

Collective Housing

- Durable
- Cost effective
- Easy renovation
- Glue-free

Residential Wetrooms

- Waterproof & watertight
- Glue-free
- Easy renovation
- Durable

Hospitality

- Durable
- Resistant to high traffic
- Waterproof & watertight
- Cost effective
- Easy renovation
- Glue-free

Education

- Resistant to high traffic
- Sound reduction
- Waterproof & watertight
- Cost effective
- Easy renovation
- Glue-free

Stores & Shops

- Resistant to high traffic
- Sound reduction
- Waterproof & watertight
- Cost effective
- Easy renovation
- Glue-free

TEKTANIUM™

Best ultra matte finish and unequalled resistance

The iD Evolution Rigid collection features our TEKTANIUM™ PU coating which uses a proprietary polymer system. This forms a naturally clear, verifiably stronger layer of protection that delivers unequalled resistance to scratches, abrasions, wear, and stains. Moreover, it offers an ultra matte finish which is visible from all angles. By combining the ultra matte effect with excellent resistance and durability, the surface appears more realistic and lasts longer. TEKTANIUM™ is the only PU coating to have all these features, so there's no need for compromise.

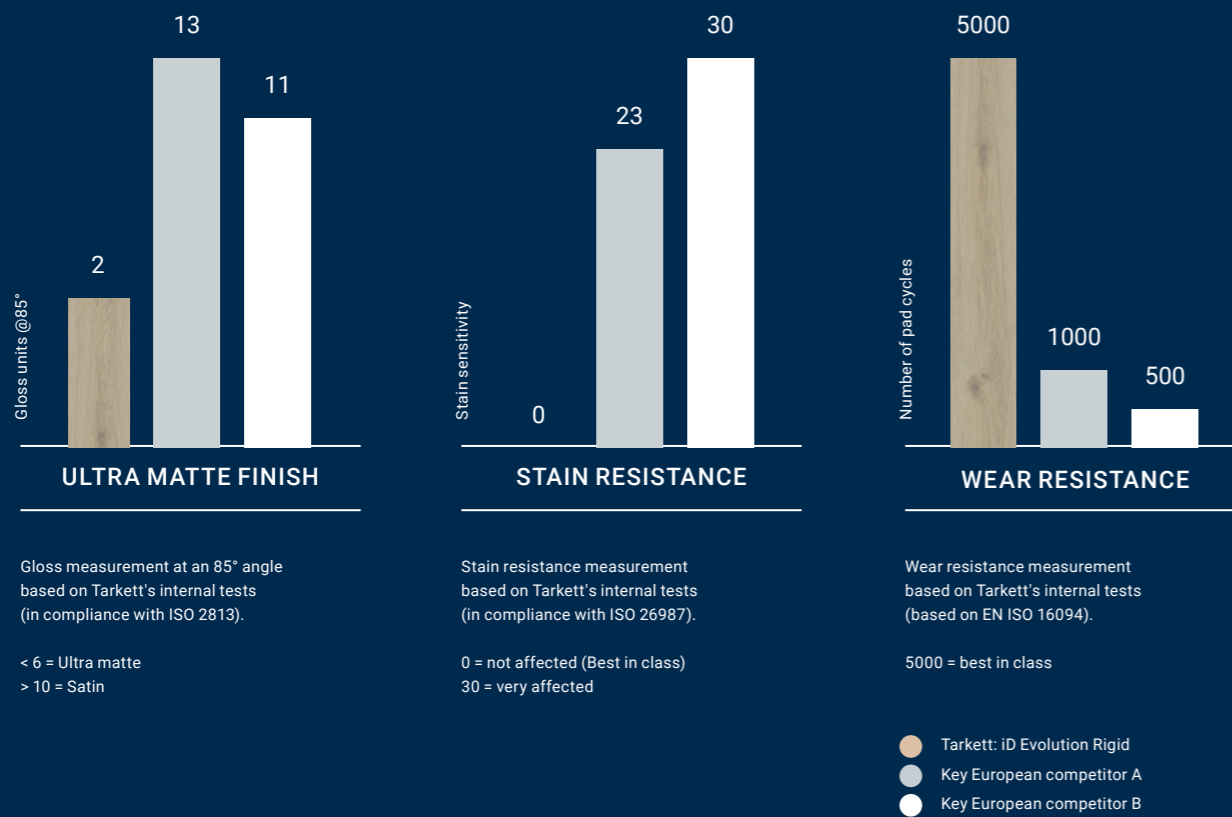

Advanced Performance



Soundproof

Experience a quieter environment with iD Evolution Rigid floorings. Achieve an 18dB impact sound reduction, providing significant noise reduction in any room. Save on costs with iD Evolution Rigid's integrated acoustic backing, eliminating the need for additional acoustic underlay.

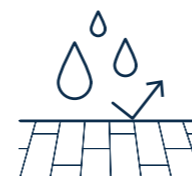

Suitable for bathrooms and kitchens

Ideal for use in bathrooms and kitchens, iD Evolution Rigid is designed with a watertight locking system that effectively prevents water leakage. This flooring solution offers reliable slip resistance with a rating of R10, ensuring safety in wet environments.

Easy & Fast Installation

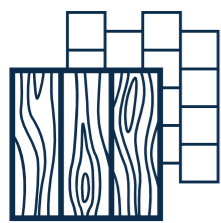

Renovation-proof

The iD Evolution Rigid collection allows for easy replacement of damaged sections and is enhanced by its acoustic backing which adds comfort and sound insulation. Installed directly over ceramic tiles and most existing subfloors, this collection minimises downtime and is ready to use immediately.



GLUE FREE
INSTALLATION

Glue-free

The iD Evolution Rigid collection is glue-free, offering a versatile, economical, and environmentally-friendly choice for both residential and commercial applications. One of its primary benefits is the ease of installation, making it a DIY-friendly option that saves on professional labour costs and speeds up the process since there's no need to wait for the adhesive to set.

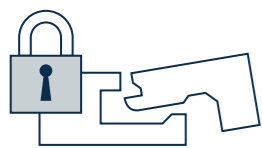

Click

Click flooring is easy and quick to install, often without the need for glue or nails, and can be laid over various subfloors. It is durable, easy to maintain, and cost-effective, with many budget-friendly options that reduce installation costs.



PATINA CONCRETE Soft Grey | 280045 009



DELICATE OAK Grey | 280041 006

Authentic Design

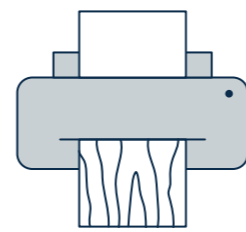

HD digital print

Discover our advanced digital printing technology, enabling us to reveal subtle details of the wood decor. Digital printing enables high-quality, realistic patterns that replicate natural materials while providing cost-effective versatility and faster production times.

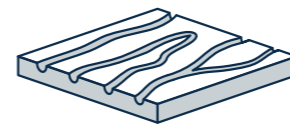







Natural design

Opting for natural design brings the beauty of the outdoors into your home, creating a warm and inviting atmosphere. The authentic textures and organic patterns of natural materials, such as wood or stone, provide a timeless and sophisticated look. The iD Evolution Rigid collection not only enhances your interiors but also aligns with sustainable living principles.







Collection

The iD Evolution Rigid collection is designed with nature in mind. Digital print technology allows us to capture the essence of natural materials.

Patina Concrete

Soft Grey		Middle Grey	
<p> 280042 009 638 x 310 mm NCS S 4000_N LRV 35,21%</p> <p> 280045 009 776 x 387 mm</p>	<p> 280042 010 638 x 310 mm NCS S 5000_N LRV 26,2%</p> <p> 280045 010 776 x 387 mm</p>		





Chatillon Oak

Light Brown		Light Beige	
<p> 280041 001 1290 x 173 mm NCS S 5010_Y30R LRV 25%</p> <p> 280044 001 1290 x 203 mm</p>	<p> 280041 002 1290 x 173 mm NCS S 3010_Y30R LRV 38,64%</p> <p> 280044 002 1290 x 203 mm</p>		

Highland Oak

Sand	
<p> 280041 003 NCS S 3005_Y20R LRV 43,55% 1290 x 173 mm</p>	
Beige	
<p> 280041 004 NCS S 3010_Y20R LRV 36,5% 1290 x 173 mm</p>	
Gold	
<p> 280041 005 NCS S 4010_Y40R LRV 37,17% 1290 x 173 mm</p>	

Delicate Oak

Grey	
<p> 280041 006 NCS S 4005_Y50R LRV 28,42% 1290 x 173 mm</p>	
Desert	
<p> 280041 007 NCS S 3010_Y40R LRV 37,79% 1290 x 173 mm</p>	
Light Brown	
<p> 280041 008 NCS S 4020_Y30R LRV 29,35% 1290 x 173 mm</p>	

Patina Concrete

The classic and delicate structure of Patina concrete allows a realistic used-concrete floor effect. Its two levels of neutral grey tones make it the ideal candidate for stylish projects. From an industrial to street look, or from the reclaimed to craft trend, this texture is the best choice to enhance the personality of your projects.



PATINA CONCRETE Soft Grey | 280042 009

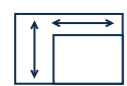

638 x 310 mm
776 x 387 mm



Available for both
iD Evolution Rigid Home
and iD Evolution



Angle-to-Angle
Click system



Push-Down
Click system



Soft Grey

280042 009 NCS S 4000_N LRV 35,21%
280045 009



Middle Grey

280042 010 NCS S 5000_N LRV 26,2%
280045 010

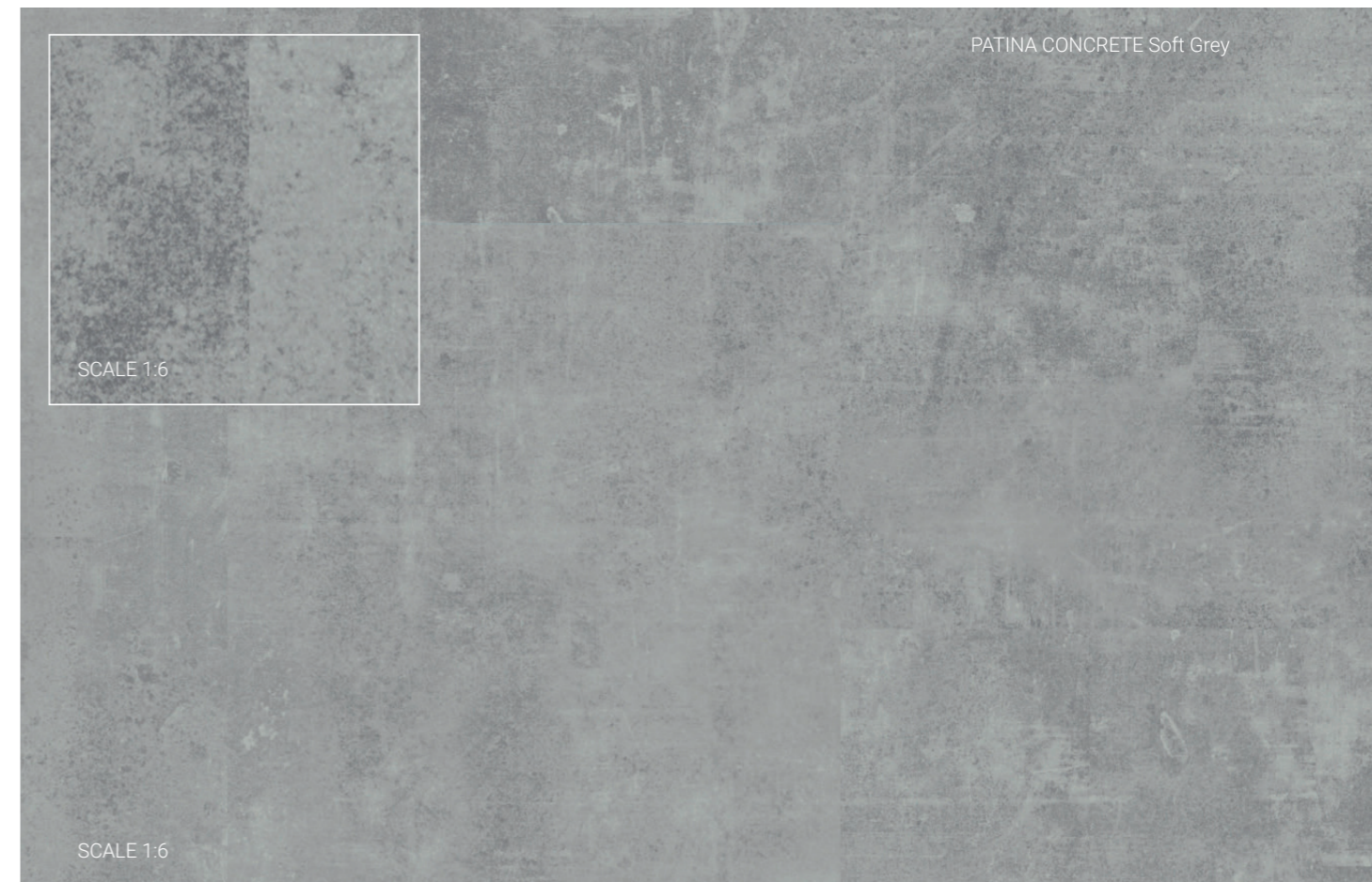

PATINA CONCRETE Soft Grey

SCALE 1:6

SCALE 1:6

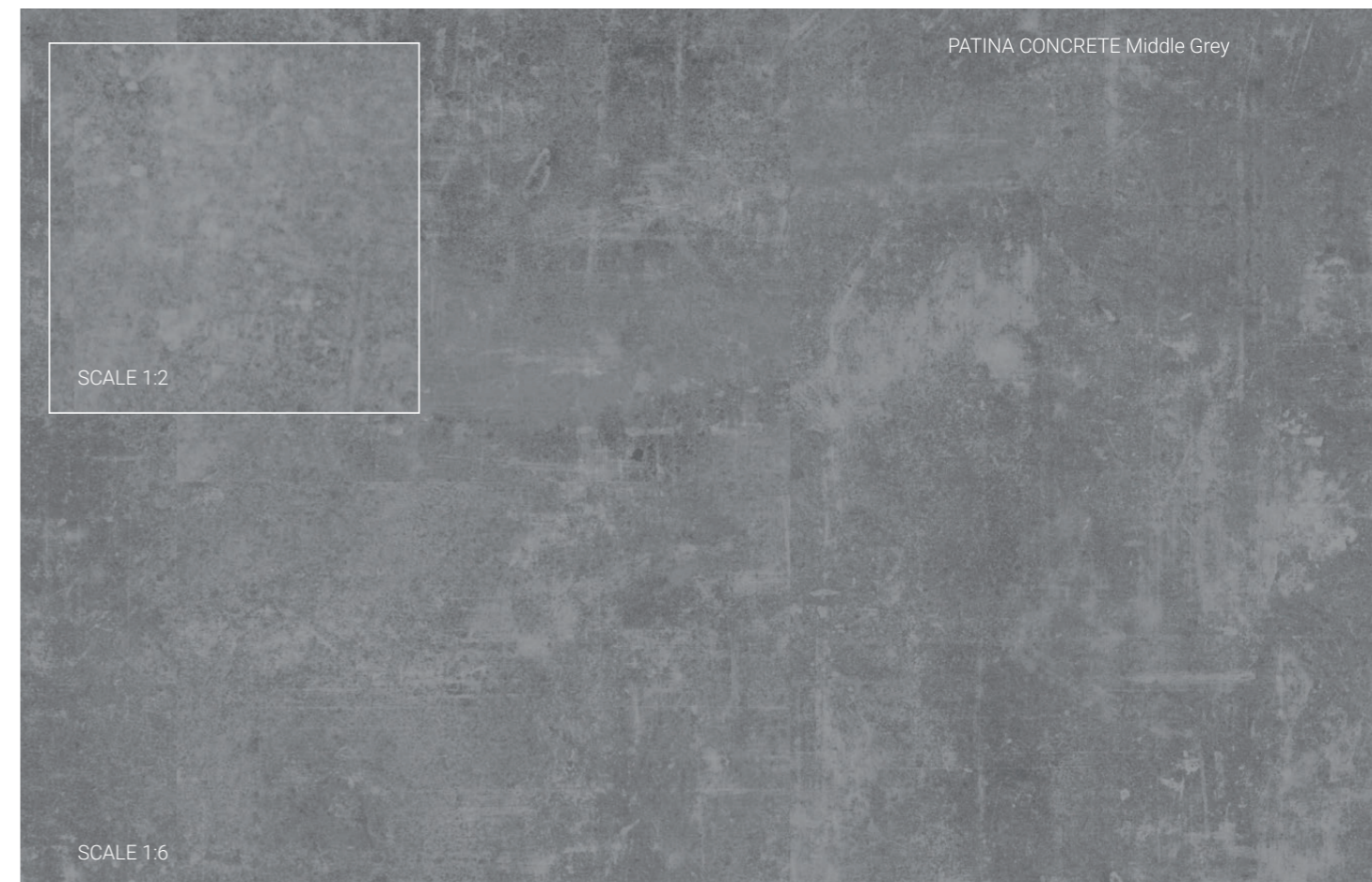

PATINA CONCRETE Middle Grey

SCALE 1:2

SCALE 1:6

CHATILLON OAK Light Brown



SCALE 1:2

SCALE 1:6

CHATILLON OAK Light Beige



SCALE 1:2

SCALE 1:6

Chatillon Oak

Developed from a selection of premium oak planks, this design helps create reassuring environments. Chatillon Oak's simplicity makes it an all-purpose wood that adapts easily to any space.



CHATILLON OAK Light Brown | 280041 001



Light Brown

280041 001

NCS S 5010_Y30R LRV 25%

280044 001



Light Beige

280041 002

NCS S 3010_Y30R LRV 38,64%

280044 002

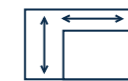

1290 x 173 mm

1290 x 203 mm



Available for both iD Evolution Rigid Home and iD Evolution



Angle-to-Angle Click system



Push-Down Click system

Highland Oak

In three warm colours, Highland Oak is an elegant wood with a beautiful grain and cerused finish. A semi-rustic, playful design that uses high contrast to create charming interiors.



Available
iD Evolution Rigid Home

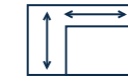

1290 x 173 mm



Angle-to-Angle
Click system



HIGHLAND OAK Sand | 280041 003



Sand 280041 003

NCSS 3005_Y20R

LRV 43,55%



Beige 280041 004

NCSS 3010_Y20R

LRV 36,5%



Gold 280041 005

NCSS 4010_Y40R

LRV 37,17%

HIGHLAND OAK Sand



SCALE 1:2

SCALE 1:6

HIGHLAND OAK Beige



SCALE 1:2

SCALE 1:6

HIGHLAND OAK Gold



SCALE 1:2

SCALE 1:6

Delicate Oak

The graceful cathedrals of Delicate Oak are punctuated by organic knots. The softly rustic design of this classic oak is available in three colour options. A Grey, Light Brown, and a Desert shade have been developed to display the natural beauty of the wood.

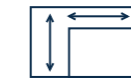

1290 x 173 mm



Available
iD Evolution Rigid Home



Angle-to-Angle
Click system



DELICATE OAK Desert | 280041 007



Grey 280041 006

NCSS 4005_Y50R

LRV 28,42%



Desert 280041 007

NCSS 3010_Y40R

LRV 37,79%



Light Brown 280041 008

NCSS 4020_Y30R

LRV 29,35%

DELICATE OAK Grey



SCALE 1:2

SCALE 1:6

DELICATE OAK Desert

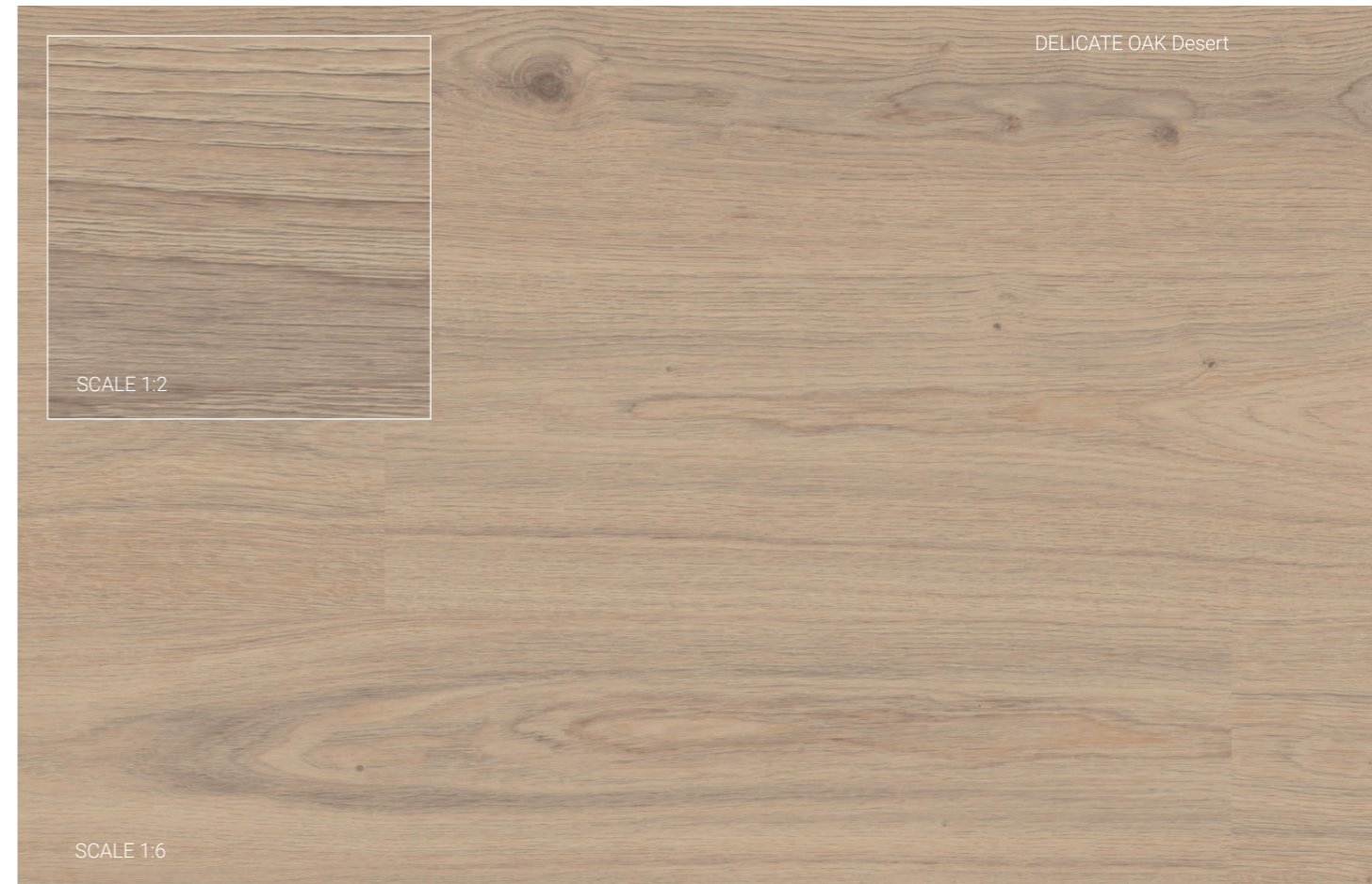

SCALE 1:2

SCALE 1:6

DELICATE OAK Light Brown



SCALE 1:2

SCALE 1:6

Accessories

SKIRTING



NON-PVC DECORATIVE SKIRTING

- **Material:** 100% recyclable white polystyrene that contains a minimum of 30% recycled content
- **Colour:** white, but can be repainted
- **Size:** L2400 x W13 x H60 mm
- **Packaging:** each box contains six pieces of a combined length of 14.4m

● White 1411 900

STAIRS

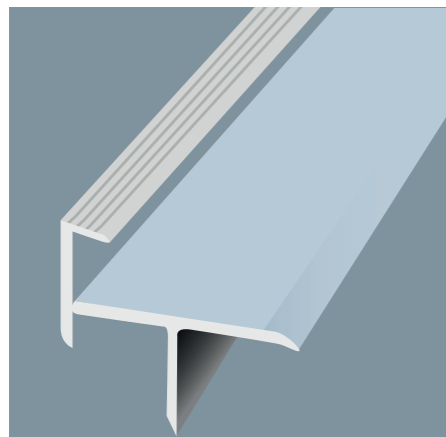

ALUMINIUM STAIRNOSE FOR VERY HIGH TRAFFIC

- Ribbed surface, slip-resistant
- Elegant finish
- To be screwed
- **Size:** L2500 x W40 x H5 mm
- **Packaging:** 10 units

● Silver 1434 021
● Stainless steel 1434 022

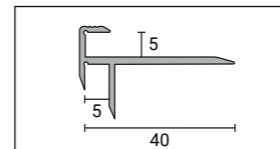

TRANSITION PROFILES

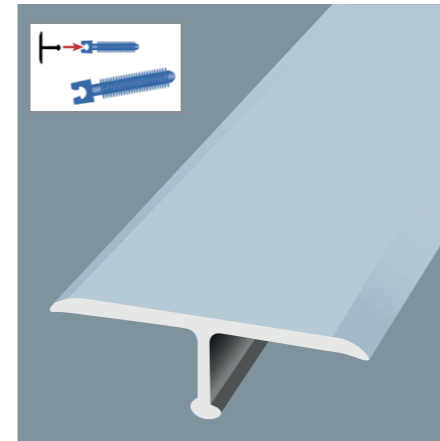

LUXURY TILES TRANSITION STRIP GENERAL TRAFFIC

- To be screwed
- Elegant finish with smooth surface and no visual screws
- Bendable with radius 60 cm
- **Size:** L2700 x W24 x H6 mm
- **Packaging:** - full kit includes top profiles and dowls.
- 10 units (27lm)

● Silver 1451 021
● Stainless steel 1451 022

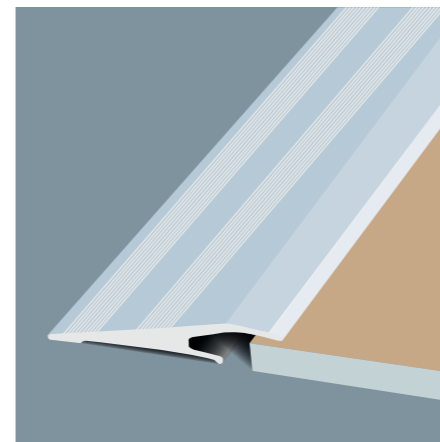
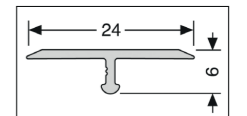

RAMP PROFILE FOR HEAVY TRAFFIC

- Aluminium ramp profile used in very heavy traffic areas
- To be screwed
- **Size:** L2700 x W38 x H5 or 7 mm
- **Packaging:** - full kit includes: Ramp profiles
+ Screws / Dowls diameter 5 mm
- 10 units (27lm)

● Silver 1454 011
● Stainless steel 1454 012

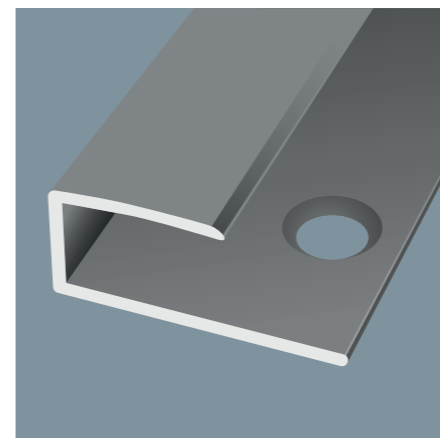
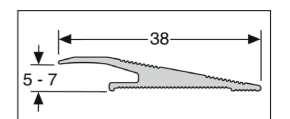

LUXURY TILES STOP

- Aluminium profile to secure and offer a net finish at the end of a floor covering
- To be screwed
- **Size:** L2700 X W23 mm x H13 mm
- **Packaging:** 10 units (27lm)

● Stainless steel 1456 013

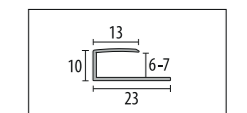



iD Evolution Rigid Collections

Technical data	Standard	iD Evolution Rigid Home	iD Evolution Rigid
Classification	Norm	Tarkett value	Tarkett value
Type of floorcovering coverings	EN ISO 16511	Modular mechanical locked floor coverings	Modular mechanical locked floor coverings
Domestic classification	EN ISO 16511	23 Heavy	23 Heavy
Commercial classification	EN ISO 16511	31 Moderate	34 Heavy
Technical Characteristics	Norm	Tarkett value	Tarkett value
Total thickness	EN ISO 24346	5.00 mm	5.70 mm
Total weight	EN ISO 23997	6270 g/m ²	7250 g/m ²
Surface treatment		TEKTANIUM®	TEKTANIUM®
Bevelled edges		4 sides	4 sides
Installation method		Click	Click
Performances for CE Marking Requirements	Norm	Tarkett value	Tarkett value
Declaration of Performance	EN 14041	0132-0096-DoP-2024-10	0132-0097-DoP-2024-10
Technical Performances	Norm	Tarkett value	Tarkett value
Dimensional stability	EN ISO 23999	Average measured value : ≤ 0.10 %	Average measured value : ≤ 0.10 %
Curl resultant to heat	EN ISO 23999	≤ 1.5 mm	≤ 1.5 mm
Reaction to fire	EN 13501-1	C _f -s1	C _f -s1
Residual indentation	EN ISO 24343-1	≤ 0.10 mm	≤ 0.10 mm
Impact sound reduction - ΔL _w	EN ISO 717-2	18 dB	18 dB
Reduction of in-room impact noise	NF S31-074	Class C (75 ≤ Ln,e,w < 85 dB)	Class C (≤ 85 dB)
Castor chair resistance	EN ISO 4918	No damage	No damage
Effect of furniture leg	EN ISO 16581	No damage	No damage
Thermal resistance	EN ISO 10456	0.05 m ² ·K/W	0.05 m ² ·K/W
Light fastness	EN ISO 105-B02	≥ 6	≥ 6
Chemical resistance	EN ISO 26987	Good resistance	Good resistance
Slip resistance	EN 16165-B EN 13893	R9 Class DS (u ≥ 0.30)	R10 Class DS (M ≥ 0.30)
Peeling Resistance	EN ISO 24345	≥ 50N/50 mm	≥ 50N/50 mm
Underfloor heating		Suitable (subfloor temperature maximum 27°C)	Suitable (subfloor temperature maximum 27°C)
Sustainability Performances	Norm	Tarkett value	Tarkett value
Recyclable		Offcuts and post-use. Contract Tarkett for more info	Offcuts and post-use. Contract Tarkett for more info
Recycled content	ISO 14021	≥ 25 %	≥ 25 %
Carbon Footprint (Cradle-to-Gate, EPD Modules A1-A3)		8.78 kg CO ₂ ,eq /m ²	9.65 kg CO ₂ ,eq /m ²
Total Carbon Footprint (EPD Modules A-D, incl. recycling)		7.93 kg CO ₂ ,eq/m ²	8.77 kg CO ₂ ,eq /m ²
Total VOC Emissions (after 28 days)	EN 16516	Gold (≤ 100 ug/m ³)	Gold (≤ 100 pg/m ³)
Dimensions and designs		Tarkett value	Tarkett value
Plank		1290 x 173 mm 11 planks = 2.455 m ² /box - 48 boxes/pallet	1290 x 203 mm 11 planks = 2.455 m ² /box - 48 boxes/pallet
Tile		638 x 310 mm 12 tiles = 2.373 m ² /box - 44 boxes/pallet	776 x 387 mm 12 tiles = 2.373 m ² /box - 44 boxes/pallet
Number of designs available		10	4

Non contractual picture.

The above information is subject to modification for the benefit of further improvement. (10/24).
According to the European Regulation N° 305/2011 for CE Marking, the Declarations of Performance are available on our website www.tarkett.com
Tarkett's instructions regarding installation, cleaning and maintenance should be observed. Please contact Tarkett at the address shown for these instructions.



PATINA CONCRETE Middle Grey | 280045 010
HIGHLAND OAK Gold | 280041 005



■ **WESTERN EUROPE:** Austria: Tarkett Holding GmbH - Tel. +43 1 716 440 ■ **Belgium:** Tarkett Belux Sprl - Tel. +32 52 26 24 11 ■ **Denmark:** Tarkett A/S - Tel. +45 43 90 60 11 ■ **Finland:** Tarkett Oy - Tel. +358 9 4257 9000
■ **France:** Tarkett SAS - Tel. +33 1 41 20 42 49 ■ **Germany:** Tarkett Holding GmbH - Tel. +49 621 68172 300 ■ **Greece:** Tarkett Monoprosopi Ltd - Tel. +30 210 6745 340 ■ **Italy:** Tarkett S.p.A. - Tel. +39 0744 7551 ■ **Luxembourg:** Tarkett GDL SA - Tel. +352 949 211 8804 ■ **Netherlands:** Tarkett BV - Tel. +31 416 685 491 ■ **Norway:** Tarkett AS - Tel. +47 32 20 92 00 ■ **Portugal:** Tarkett SA - Tel. +351 21 427 64 20 ■ **Spain:** Tarkett Floors S.L. - Tel. +34 914 951 400
■ **Sweden:** Tarkett Sverige AB - Tel. +46 771 25 19 00 ■ **Switzerland:** Tarkett Holding GmbH - Tel. +41 43 233 79 24 ■ **Turkey:** Tarkett Turkey - Tel. +90 212 213 65 80 ■ **United Kingdom:** Tarkett Ltd - Tel. +44 (0) 1622 854 040
■ **EASTERN EUROPE:** Baltic Countries: Estonia: Tel. +372 55 51 5880 ■ Latvia: Tel. +371 26 112014 ■ Lithuania: Tel. +370 37 262220 ■ **Czech Republic:** Tarkett org. složka - Tel. +420 271 001 600 ■ **Hungary:** Tarkett Polska Sp.z o.o. magyarországi fióktelepe - Tel. +36 1 437 8150 ■ **Kazakhstan:** Tarkett Kazakhstan - Tel. +7 7172 79 00 99 ■ **Poland:** Tarkett Polska Sp. z o.o. - Tel. +48 22 16 09 231 ■ **Russian Federation:** ZAO Tarkett RUS - Tel. +7 495 775 3737 ■ **Slovakia:** Tarkett Polska Sp. z o.o. organizačná zložka - Tel. +421 2 48291 317 ■ **South East Europe:** Tarkett SEE - Tel. +381 21 7557 649 (44) 569 12 21 ■ **Ukraine:** Tarkett UA - Tel. +38 (0) 44 35 45 621 ■ **ASIA AND OCEANIA:** Australia: Tarkett Australia Pty Ltd - Tel. +61 2 88 53 12 00 ■ **China:** Tarkett Floor Covering (Shanghai) Co. Ltd. - Tel. +86 (21) 60 95 68 38 ext 841 ■ **North East Asia:** Tarkett Hong Kong Limited - Tel. +852 2511 8716 ■ **India:** Tarkett Flooring India Pvt. Ltd. - Bangalore - Tel. +91 80 4130 3793 - New Delhi - Tel. +91 11 4352 4073 - Mumbai - Tel. +91 22 2648 8750 ■ **South East Asia:** Tarkett Flooring Singapore Pte. Ltd. - Tel. +65 6346 1585 ■ **AFRICA:** Tarkett International: Tel. +33 1 41 20 41 01 ■ **MIDDLE EAST:** Tarkett Middle East: Tel. +961 1 51 3363/4 ■ **Israel:** Tarkett International: +33 1 41 20 41 01 ■ **NORTH AMERICA:** USA: Tarkett Inc. - Tel. +1 713 869 5811 / Johnsonite - Tel. +1 440 543 8916 ■ **Canada:** Tarkett Inc. - Tel. +1 450 293 173 ■ **LATIN AMERICA:** Brazil: Tarkett Brasil: Tel. +55 12 3954 7108 ■ **Argentina - Chile - Uruguay:** Tarkett Mercosur - Tel. +54 11 47 08 07 72 / +54 9 11 44 46 88 82
■ **Bolivia - Colombia - Ecuador - Panama - Paraguay - Peru - Trinidad and Tobago - Venezuela:** Tarkett Latam - Tel. +55 11 9 8410 9310 / +55 11 95494 0069 ■ **Mexico / Central America:** Tarkett Mexico - Tel. +55 11 98410 9310

Designs and photos used in this brochure are for illustration purposes only. Images are not contractual images and do not stand for product recommendation. Due to evolution of standards, characteristics indicated in the text and images are not binding only after confirmation by our departments.

Design: Tarkett Internal Agency / Photos & 3D: 3DStudio - Shutterstock
professionals.tarkett.com

