

2018 collections

LUXURY VINYL TILES

Browse
through our
commercial
LVT range



Widening your horizons!

Flooring trends change throughout the years as technologies improve and push the boundaries of flooring design. Colours, textures and shapes continue to exert a strong influence on end-users' perceptions. With our 12 collections, you can look for new and exciting options, blending textures, shades and shapes for the perfect look and feel. Enjoy access to new state-of-the-art collections and get creative with your favorite flooring solutions.

Get inspired, get creative!

SUMMARY

Glue-down:

iD Supernature & Tattoo	4
iD Mixonomi	14
iD Inspiration 55-70	22
iD Inspiration 40	36
iD Essential 30	44

Click:

iD Click Ultimate	54
iD Inspiration Click	60
iD Inspiration Click ^{PLUS}	66
iD Essential Click	72

Loose-lay:

iD Inspiration Loose-Lay	80
iD Square	86
iD Tilt	94

iD Supernature & Tattoo

Select a super natural design with a no repetition effect and Customise it with 10 graphic tattoos.

Park Oak
20 x 122 cm planks
Ginger + iD Tattoo Mini Grid
Tone on Tone

Fine textures of
wood and stone
for custom looks



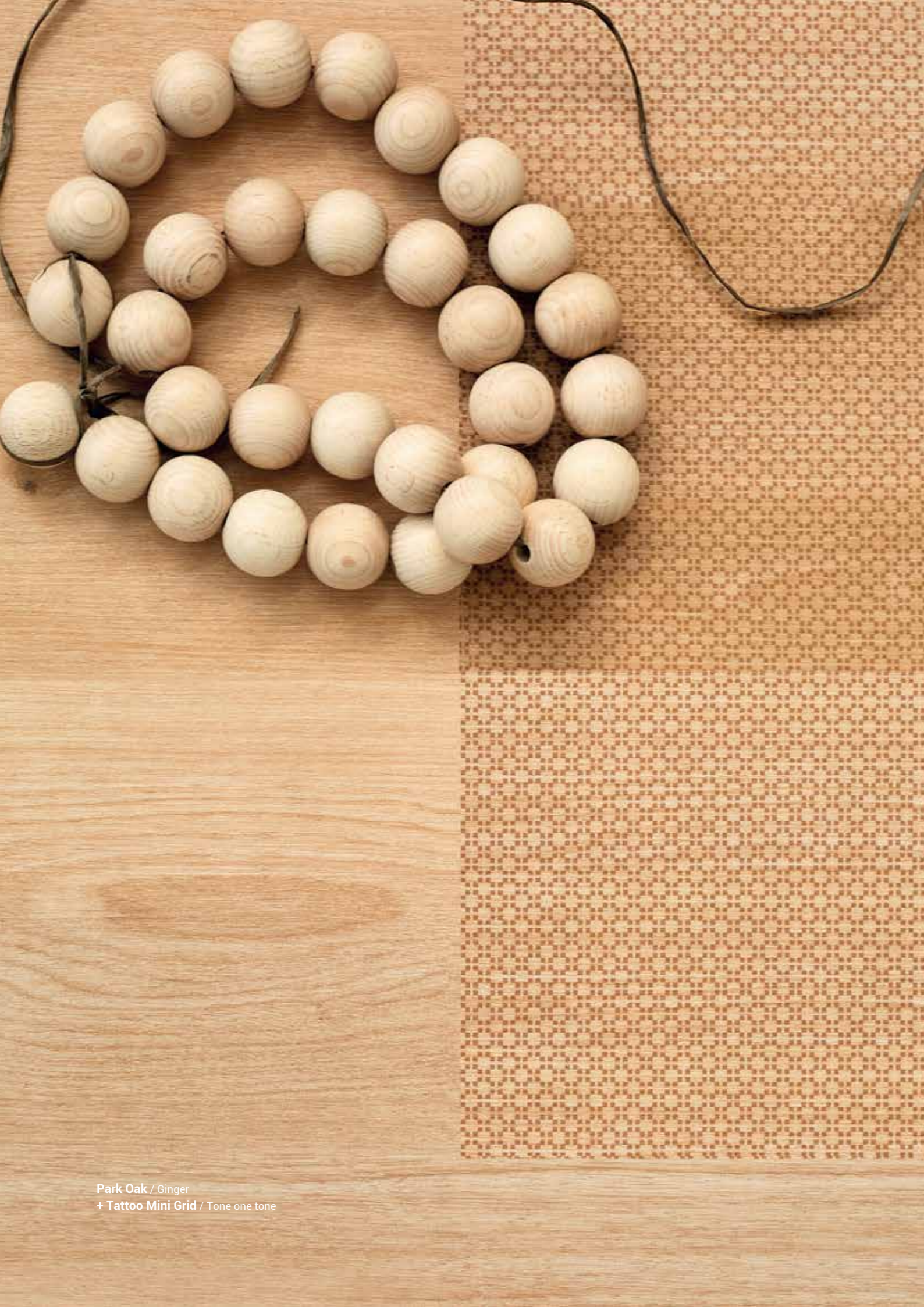

iD Supernature & Tattoo

TEXTURES, SHADES & TATTOOS

Stand out with our high definition non repeat printing technology and a natural color from real wood scanning.

- 5 wood & stone textures
- 16 natural shades
- 10 graphic tattoos

FORMATS

iD SUPERNATURE

- 8 Wood formats
- 7 Stone formats

iD TATTOO

- 9 formats

CUSTOMISATION

iD Supernature & Tattoo is a customisable flooring. Customise your iD Supernature by selecting your format, your texture and your shade to perfectly match your concept. Then add a Tattoo to delineate spaces or simply give your flooring a stylish look.

Two colouring options are available:

- Tone on Tone, a subtle tattoo that matches your selected iD Supernature base
- Colour tattoos that include Banana, Cobalt, Jade or Poppy

To support your creation process:

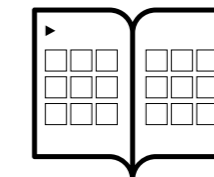

library of layouts

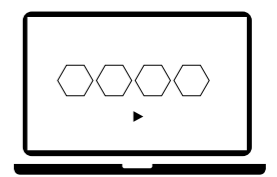

online configurator

professionals.tarkett.com/idsupernature

A SUSTAINABLE SOLUTION



*TVOC AT 28 DAYS

Helps improve indoor air quality with VOC emissions below quantifiable levels, under $10\mu\text{g}/\text{m}^3$ after 28 days (100 times lower than Europe's strictest standards).



100% recyclable & composed of 32% of recycled components.



Phthalate-free technology based on alternative plasticizers.



Made in Germany to benefit from our best-in-class industrial expertise.

iD Supernature

Garden Oak



Park Oak

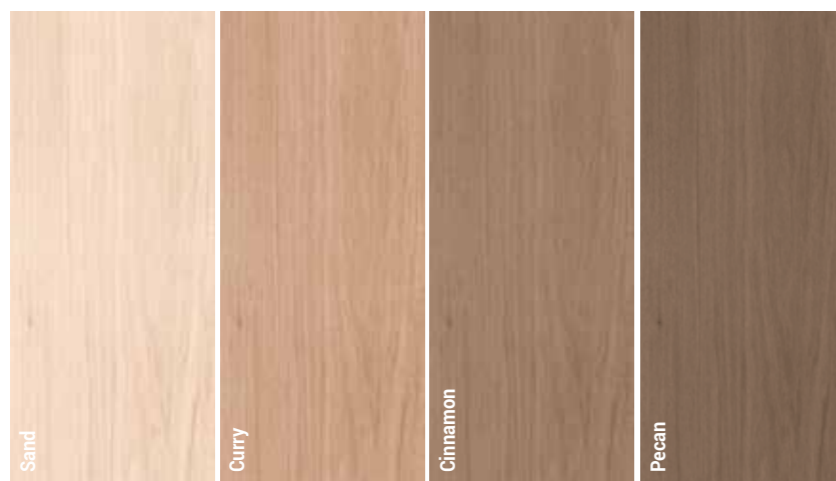
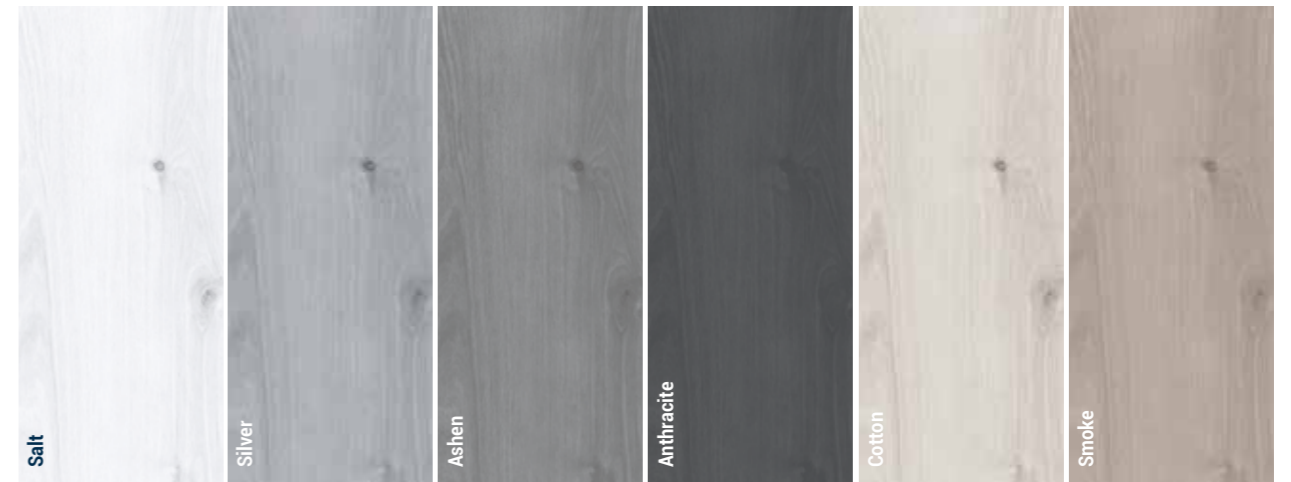

16 natural shades - 8 formats, see page 103 for more details

16 natural shades - 8 formats, see page 103 for more details

iD Supernature

Forest Oak

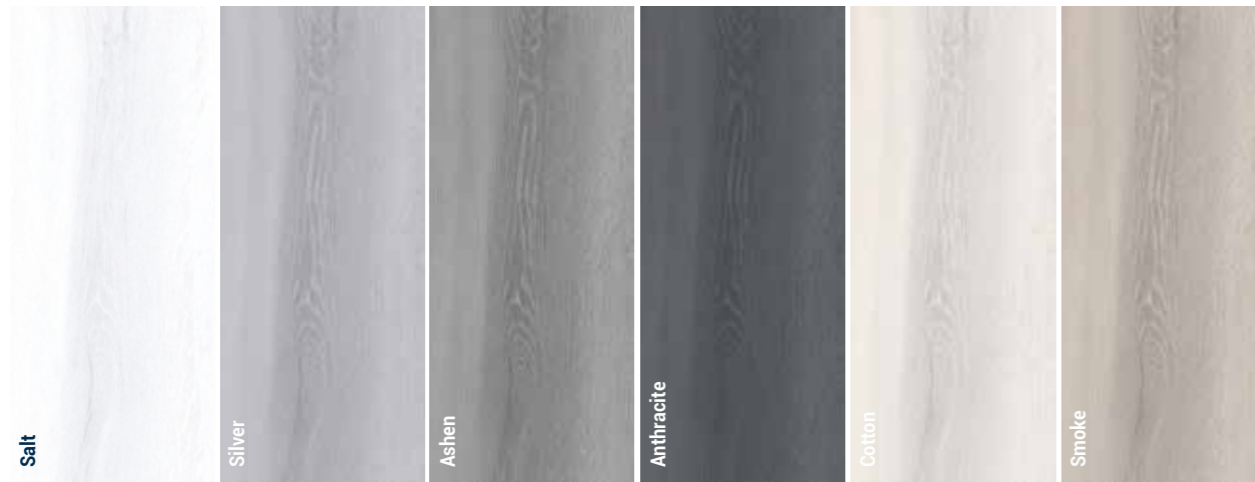

Belgian Stone

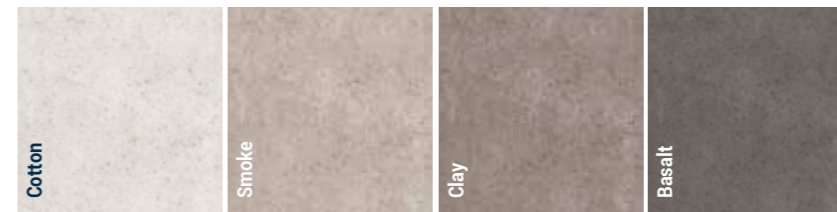
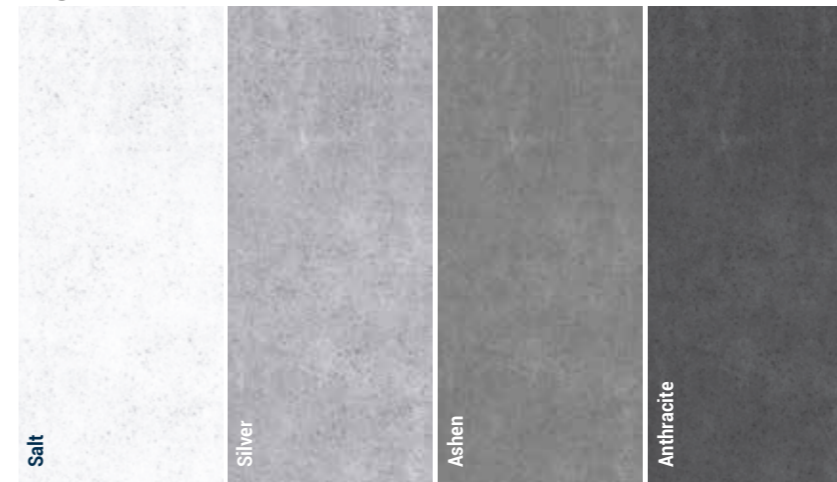

16 natural shades - 8 formats, see page 103 for more details

16 natural shades - 4 formats, see page 103 for more details

iD Supernature

Patina Concrete

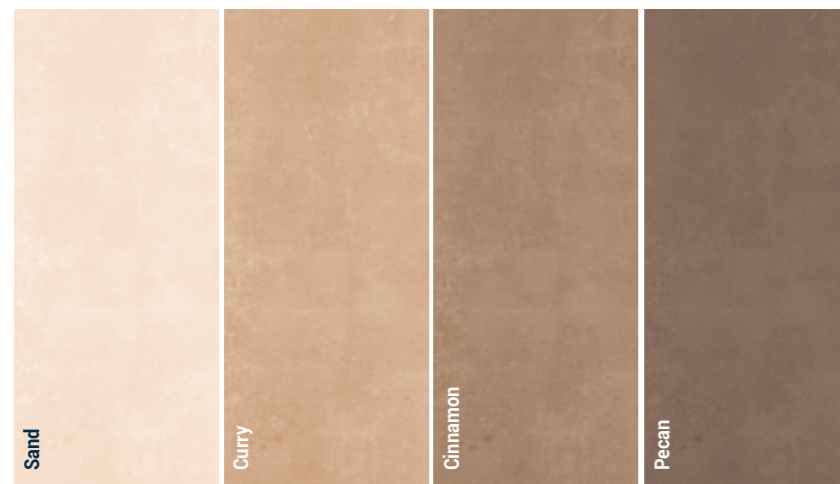
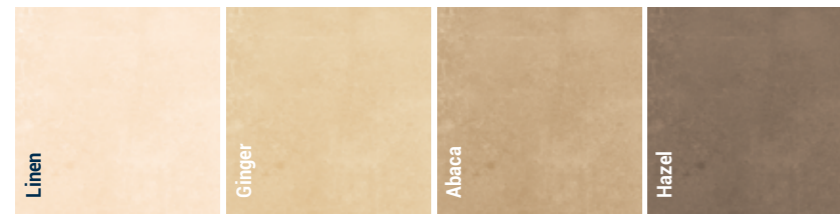
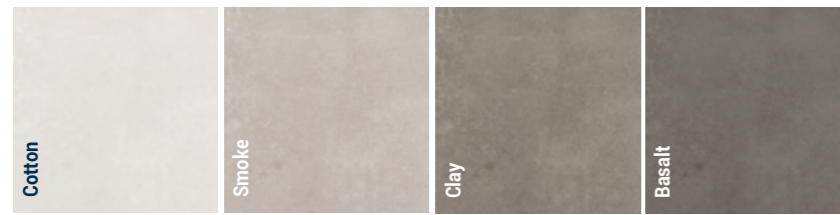
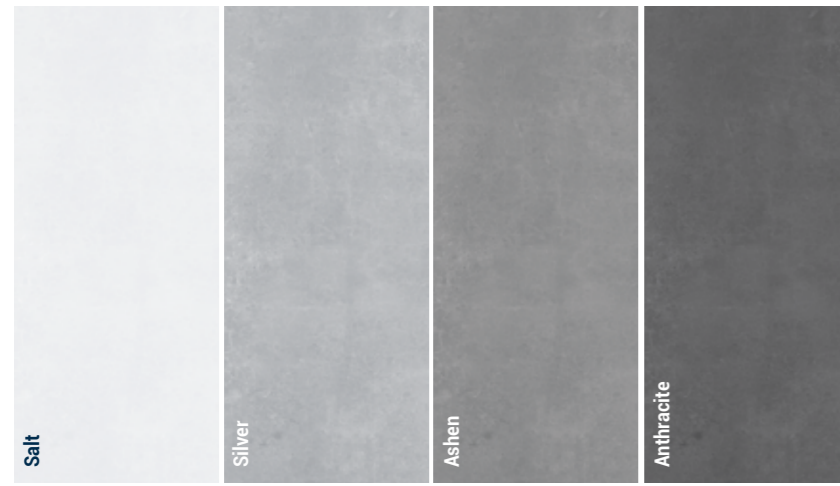

16 natural shades - 4 formats, see page 103 for more details

iD Tattoo

Scale 40%

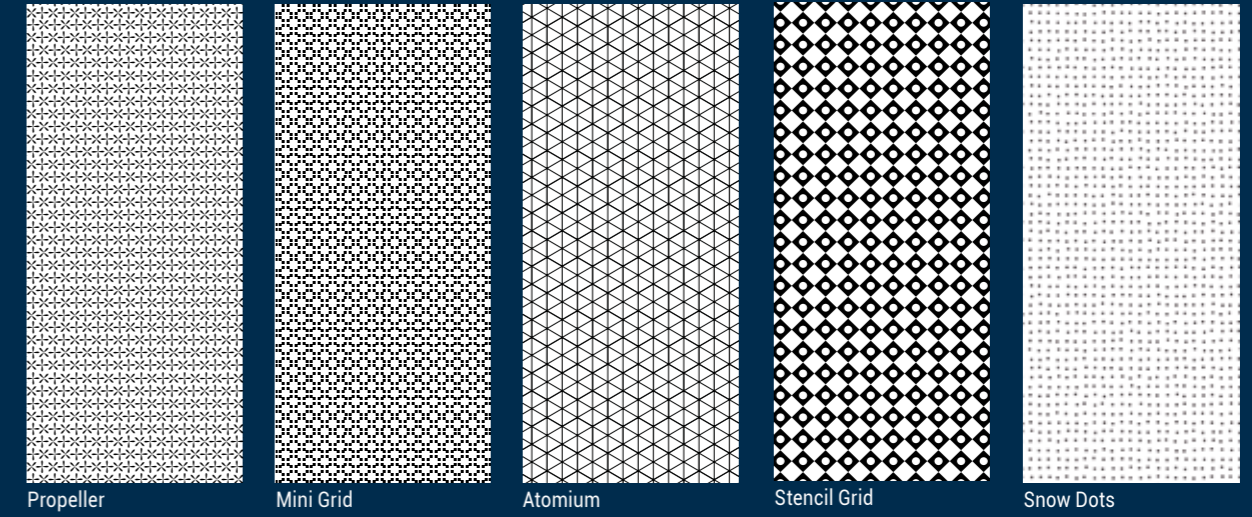

Scale 40%



Scale 10%

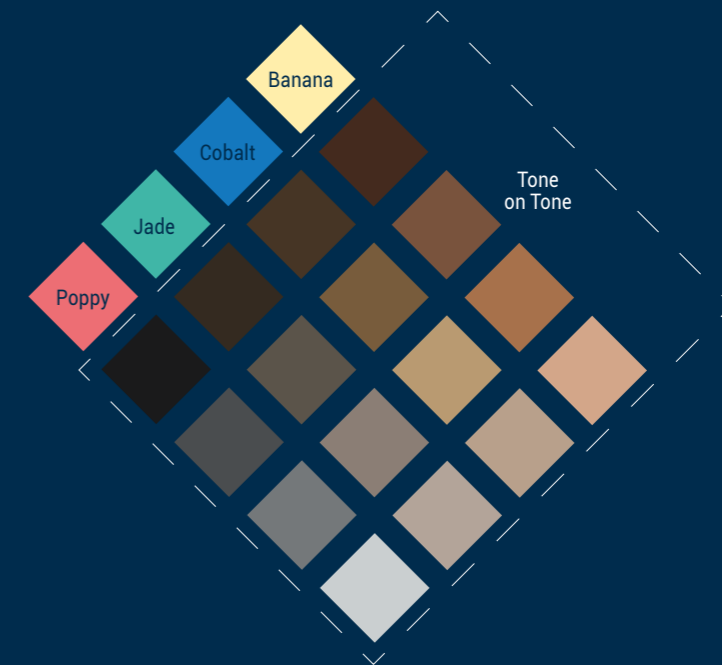
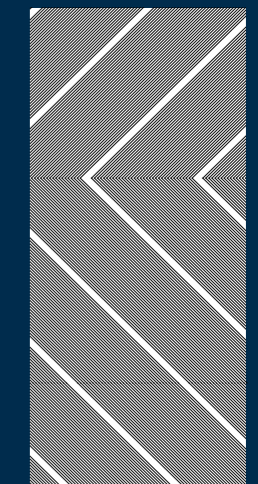
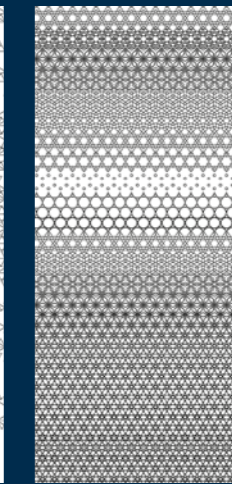

iD Mixonomi

1, 2, 3. Colour. Shape. Mix. This collection is the embodiment of a creative freedom where shapes and colours get combined and mixed together through thematic harmonies.

Trapeze 16.66 x 38.486 cm
Capuccino, Colombo

The art
of mixing





Capuccino,
Colombo

iD Mixonomi

COLOURS

We travelled the world and captured the colour souls and harmonies of inspirational places and brought them alive. Dare to stand out and use our palette of 33 colours to create a new customer experience.

SHAPES

Inspired from the iconic hexagon, the iD Mixonomi range features 7 graphic shapes that can be fully combined together. Decors are also available in 3 mini-shapes to compose interesting classic layouts.

MIX

From the mono-shape flooring layout to more elaborate compositions, mix and match multiple shapes and colours to build your own customer experience.

To support your creation process:

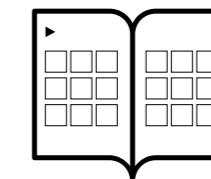

library of layouts

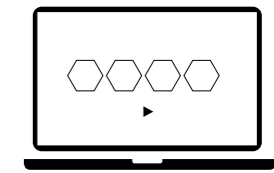

online configurator

professionals.tarkett.com/idmixonomi

A SUSTAINABLE SOLUTION



Helps improve indoor air quality with VOC emissions below quantifiable levels, under $10\mu\text{g}/\text{m}^3$ after 28 days (100 times lower than Europe's strictest standards).



Phthalate-free technology based on alternative plasticizers.



100% recyclable & composed of 32% of recycled components.



Made in Germany to benefit from our best-in-class industrial expertise.

iD Mixonomi

COLOURS

Dare to stand out and use our palette of 33 colours to create a new customer experience.



SILVER



BRASS



COPPER



MILK

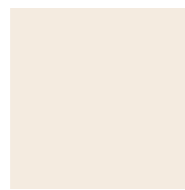

IVORY



BANANA



DRAGE



MINT



FORGET ME NOT



CAPUCCINO



CRAFT



DUNE



COLOMBO



ROSEWOOD



POPPY



JADE



AQUA



ASHES



CLAY



CHESTNUT



OCHRE



TERRACOTTA



STRAWBERRY



PEACOCK



COBALT



CHARCOAL



LIQUORICE



TOBACCO



KAHLUA



BURGUNDY



EMERALD



KENSINGTON GREEN



PRUSSIAN BLUE

See formats and codes on page 105

iD Mixonomi

SHAPES

7 COMBINABLE FORMATS

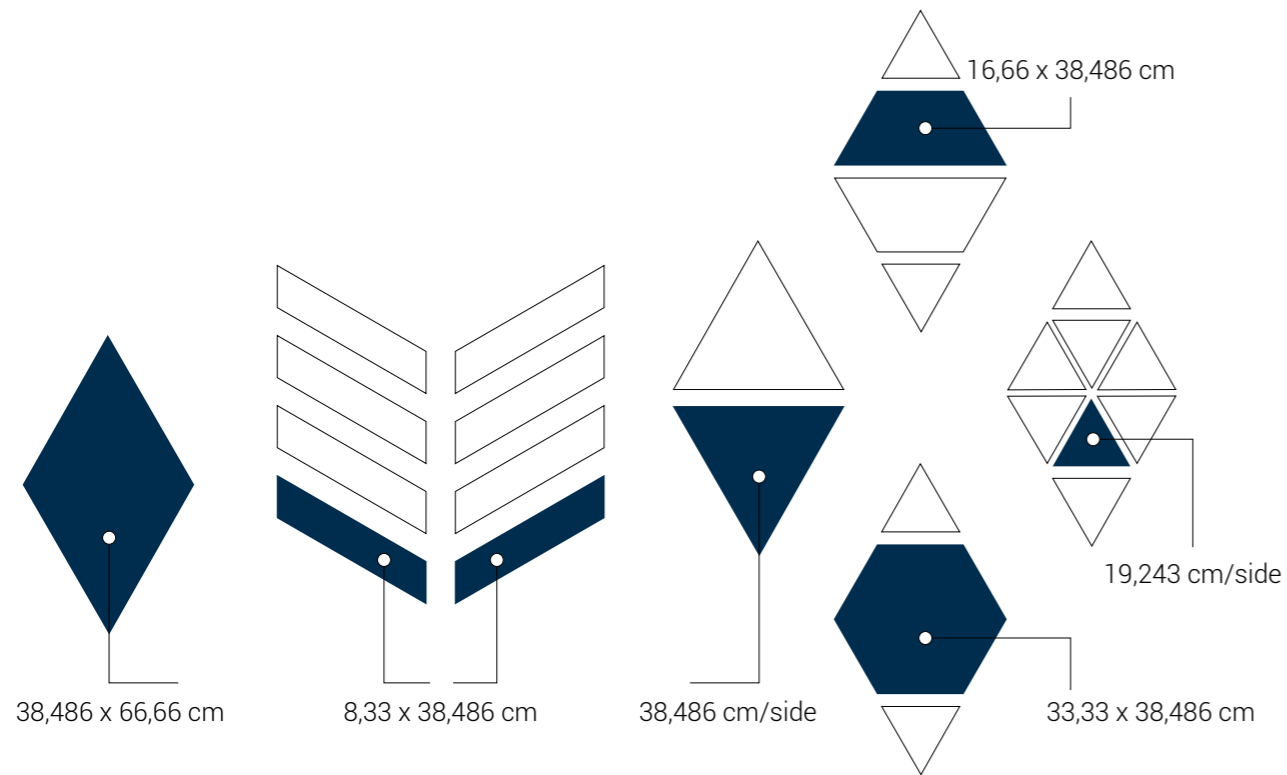

3 MINI-SHAPES FOR AN ALLOVER LOOK

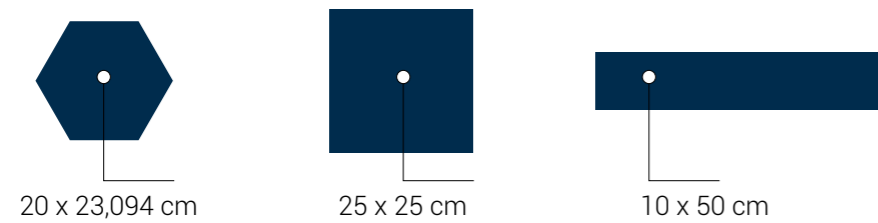

MIX

From the mono-shape flooring layout to more elaborate compositions, mix and match multiple shapes and colours to build your own customer experience.



iD Inspiration 55-70

iD Inspiration 55-70 brings design a step forward with new colours and formats. In retail, hospitality and work environments, you can create spaces that build brand image and positively shape the customer experience. For commercial environments with moderate to high traffic.

Scandinave Oak / Medium Grey
20 x 122 cm
Tisse / Green, Red, Blue
50 x 50 cm

The widest
design range
for moderate
to high traffic
environments

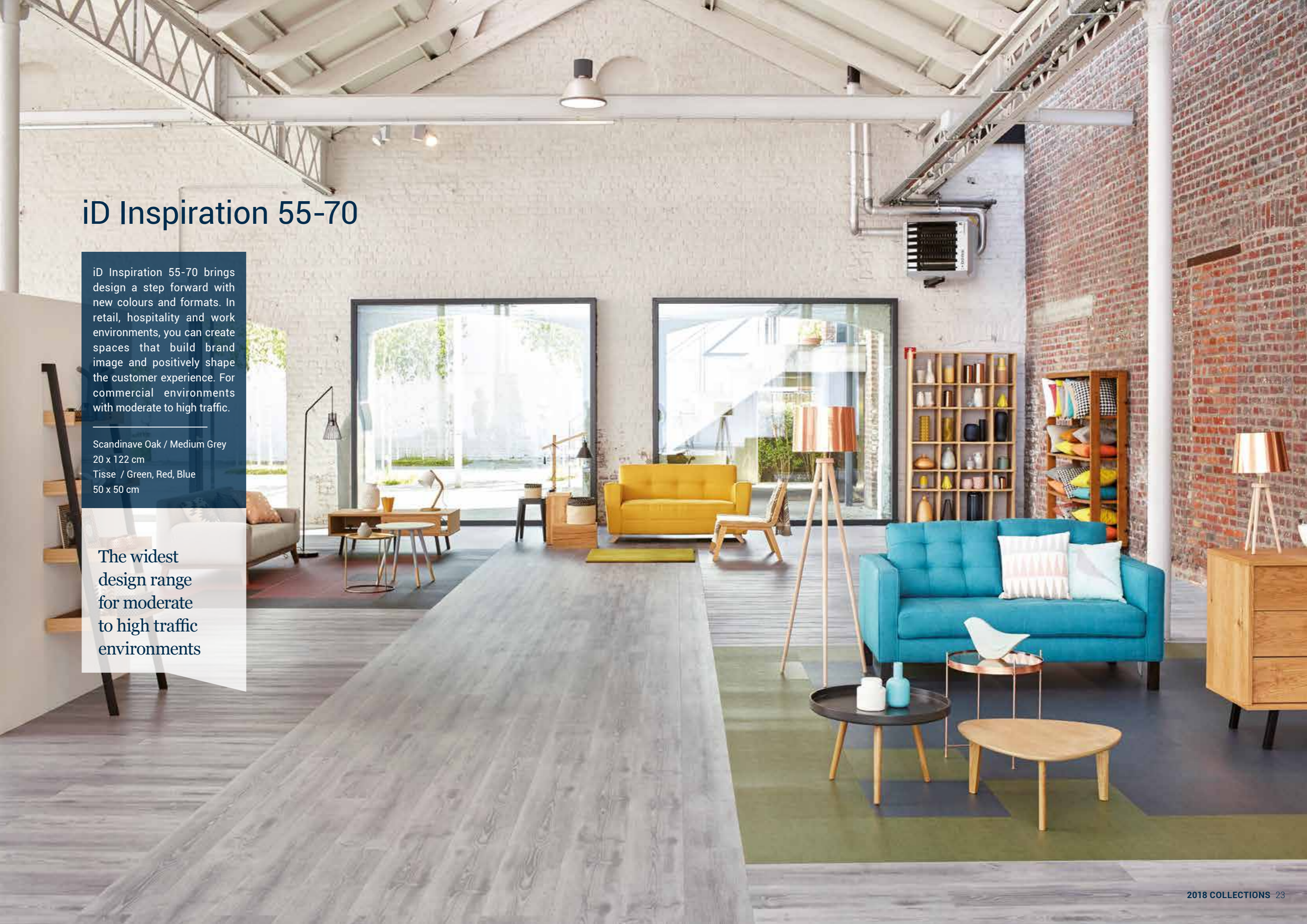



iD Inspiration 55-70

9 FORMATS :

Planks

- 16,66 x 100 cm
- 12,5 x 122 cm
- 20 x 122 cm
- 25 x 122 cm
- 25 x 150 cm

Tiles

- 25 x 50 cm
- 50 x 50 cm
- 50 x 100 cm
- 100 x 100 cm

FULLY CUSTOMISABLE COLLECTION

iD Inspiration offers endless combinations through your choice of format, design, surface structure and beveling. Every aspect of the product is customisable with all decors.

ACCURATE BEVELS

Our cutting process makes for a cleaner, more realistic bevel.

LIFE-LONG PERFORMANCE

- Highly resistant to the daily wear and tear of even the most demanding commercial areas, thanks to our unique Top Clean XP coating.
- 10 years limited guarantee for commercial use and 15 years limited guarantee for residential use.

ACCESSORY PACKAGES

- Comes with a complete range of accessories for user safety, efficient installation and project completion.
- Quick and easy installation for a long-lasting solution.

A SUSTAINABLE SOLUTION



Helps improve indoor air quality with VOC emissions below quantifiable levels, under $10\mu\text{g}/\text{m}^3$ after 28 days (100 times lower than Europe's strictest standards).



100% recyclable & composed of 32% of recycled components.



Phthalate-free technology based on alternative plasticizers.



Made in Germany to benefit from our best-in-class industrial expertise.

iD Inspiration 55-70

Antik Oak



iD 70: 24201 001 **iD 70:** 24201 005 **iD 70:** 24201 004 **iD 70:** 24201 006 **iD 70:** 24201 008 **iD 70:** 24201 003
iD 55: 24231 001 **iD 55:** 24231 005 **iD 55:** 24231 004 **iD 55:** 24231 006 **iD 55:** 24231 008 **iD 55:** 24231 003

Contemporary Oak



iD 70: 24201 109 **iD 70:** 24201 110 **iD 70:** 24201 111 **iD 70:** 24201 112
iD 55: 24231 109 **iD 55:** 24231 110 **iD 55:** 24231 111 **iD 55:** 24231 112

Antik Oak



iD 70: 24201 002 **iD 70:** 24201 007
iD 55: 24231 002 **iD 55:** 24231 007

Patina Ash



iD 70: 24201 106 **iD 70:** 24201 108 **iD 70:** 24201 107
iD 55: 24231 106 **iD 55:** 24231 108 **iD 55:** 24231 107

Elm



iD 70: 24201 113 **iD 70:** 24201 114 **iD 70:** 24201 115 **iD 70:** 24201 116 **iD 70:** 24201 117
iD 55: 24231 113 **iD 55:** 24231 114 **iD 55:** 24231 115 **iD 55:** 24231 116 **iD 55:** 24231 117

Brushed Pine



iD 70: 24201 016 **iD 70:** 24201 014 **iD 70:** 24201 015 **iD 70:** 24201 013
iD 55: 24231 016 **iD 55:** 24231 014 **iD 55:** 24231 015 **iD 55:** 24231 013

English Oak



iD 70: 24201 028 **iD 70:** 24201 029 **iD 70:** 24201 024 **iD 70:** 24201 026 **iD 70:** 24201 027 **iD 70:** 24201 025
iD 55: 24231 028 **iD 55:** 24231 029 **iD 55:** 24231 024 **iD 55:** 24231 026 **iD 55:** 24231 027 **iD 55:** 24231 025

See matching accessories page 107 and check out more formats in pages 108 - 109.

iD Inspiration 55-70

Pallet Pine



White
iD 70: 24201 030
iD 55: 24231 030

Beige
iD 70: 24201 031
iD 55: 24231 031

Natural
iD 70: 24201 032
iD 55: 24231 032

Brown
iD 70: 24201 033
iD 55: 24231 033

Scandinavian Oak



Light Beige
iD 70: 24201 100
iD 55: 24231 100

Medium Beige
iD 70: 24201 101
iD 55: 24231 101

Dark Beige
iD 70: 24201 102
iD 55: 24231 102

Light Grey
iD 70: 24201 103
iD 55: 24231 103

Medium Grey
iD 70: 24201 104
iD 55: 24231 104

Dark Grey
iD 70: 24201 105
iD 55: 24231 105

Rustic Oak



Light Grey
iD 70: 24201 124
iD 55: 24231 124

Beige
iD 70: 24201 126
iD 55: 24231 126

Natural
iD 70: 24201 125
iD 55: 24231 125

Brown
iD 70: 24201 127
iD 55: 24231 127

Medium Brown
iD 70: 24201 128
iD 55: 24231 128

Medium Grey
iD 70: 24201 123
iD 55: 24231 123

Vintage Teak

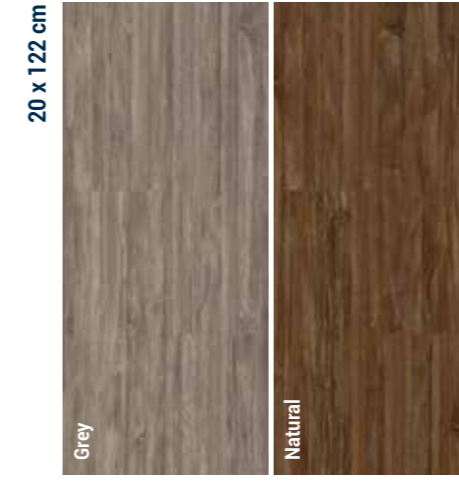

Grey
iD 70: 24201 092
iD 55: 24231 092

Natural
iD 70: 24201 093
iD 55: 24231 093

Trend Line

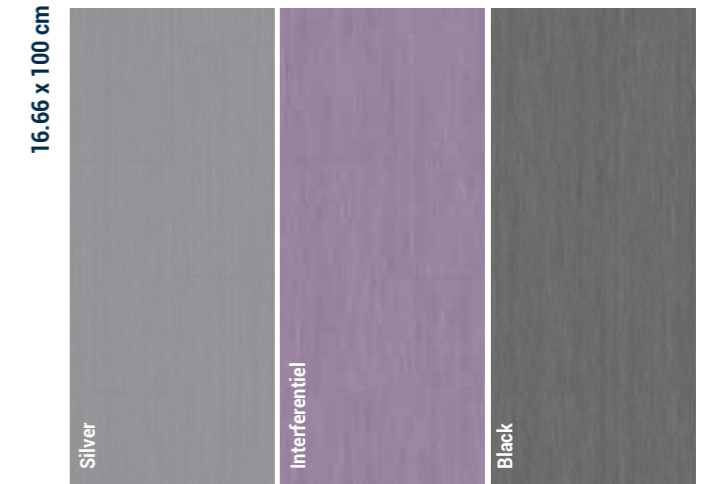

Silver
iD 70: 24205 090
iD 55: 24235 090

Interferentiel
iD 70: 24205 089
iD 55: 24235 089

Black
iD 70: 24205 088
iD 55: 24235 088

Rustic Oak



Dark Grey
iD 70: 24201 122
iD 55: 24231 122

Stone Brown
iD 70: 24201 121
iD 55: 24231 121

Wenge



Grege
iD 70: 24205 012
iD 55: 24235 012

Grey
iD 70: 24205 011
iD 55: 24235 011

Black
iD 70: 24205 009
iD 55: 24235 009

Natural
iD 70: 24205 010
iD 55: 24235 010

See matching accessories page 107

iD Inspiration 55-70

Bardiglio

50 x 50 cm

			
iD 70: 24207 034 iD 55: 24237 034	iD 70: 24207 035 iD 55: 24237 035	iD 70: 24207 036 iD 55: 24237 036	iD 70: 24207 037 iD 55: 24237 037



Rock

50 x 50 cm

			
iD 70: 24207 065 iD 55: 24237 065	iD 70: 24207 062 iD 55: 24237 062	iD 70: 24207 066 iD 55: 24237 066	iD 70: 24207 064 iD 55: 24237 064

Composite

50 x 50 cm

		
iD 70: 24207 073 iD 55: 24237 073	iD 70: 24207 072 iD 55: 24237 072	iD 70: 24207 074 iD 55: 24237 074

Rock

50 x 50 cm



iD 70: 24207 063 iD 55: 24237 063

Rustic Slate

		
iD 70: 24207 070 iD 55: 24237 070	iD 70: 24207 071 iD 55: 24237 071	iD 70: 24207 069 iD 55: 24237 069

Polished Concrete

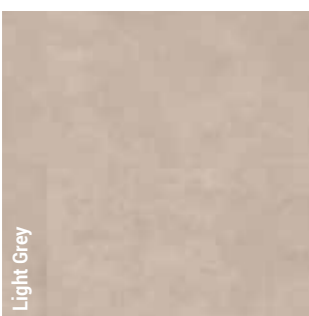
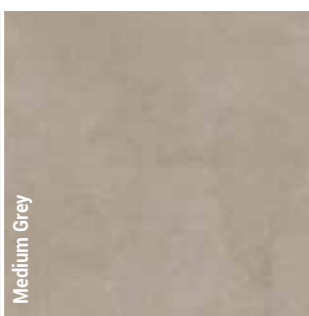
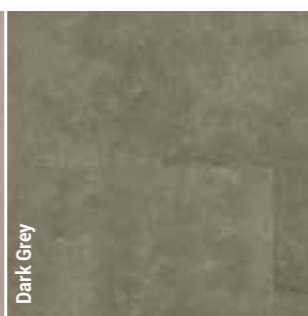
50 x 50 cm

		
iD 70: 24207 075 iD 55: 24237 075	iD 70: 24207 076 iD 55: 24237 076	iD 70: 24207 077 iD 55: 24237 077

Terrazzo

50 x 50 cm

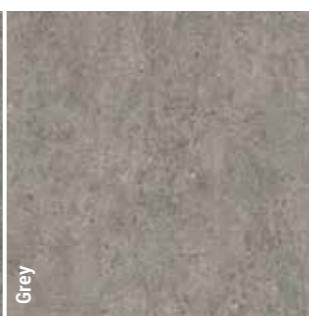
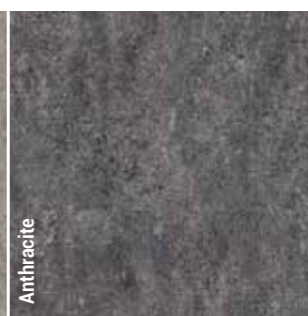
		
iD 70: 24207 130 iD 55: 24237 130	iD 70: 24207 129 iD 55: 24237 129	iD 70: 24207 131 iD 55: 24237 131

iD Inspiration 55-70

Caviar

50 x 50 cm

Grey	iD 70: 24207 019 iD 55: 24237 019	Beige	iD 70: 24207 022 iD 55: 24237 022	Foggy Blue	iD 70: 24207 023 iD 55: 24237 023	Mauve	iD 70: 24207 021 iD 55: 24237 021
-------------	--------------------------------------	--------------	--------------------------------------	-------------------	--------------------------------------	--------------	--------------------------------------

Tisse

50 x 50 cm

Light	iD 70: 24207 084 iD 55: 24237 084	Beige	iD 70: 24207 082 iD 55: 24237 082	Green	iD 70: 24207 091 iD 55: 24237 091	Blue	iD 70: 24207 087 iD 55: 24237 087
--------------	--------------------------------------	--------------	--------------------------------------	--------------	--------------------------------------	-------------	--------------------------------------

Caviar

50 x 50 cm

Misty Grey	iD 70: 24207 017 iD 55: 24237 017	Tobacco	iD 70: 24207 018 iD 55: 24237 018	Brown	iD 70: 24207 020 iD 55: 24237 020
-------------------	--------------------------------------	----------------	--------------------------------------	--------------	--------------------------------------

Tisse

50 x 50 cm

Red	iD 70: 24207 086 iD 55: 24237 086	Brown	iD 70: 24207 085 iD 55: 24237 085	Black	iD 70: 24207 083 iD 55: 24237 083
------------	--------------------------------------	--------------	--------------------------------------	--------------	--------------------------------------

Oxide

50 x 50 cm

Steel	iD 70: 24207 119 iD 55: 24237 119	Copper	iD 70: 24207 118 iD 55: 24237 118	Black Steel	iD 70: 24207 120 iD 55: 24237 120
--------------	--------------------------------------	---------------	--------------------------------------	--------------------	--------------------------------------

Vintage Zinc

50 x 50 cm

Silver	iD 70: 24207 096 iD 55: 24237 096	Rust	iD 70: 24207 095 iD 55: 24237 095	Black	iD 70: 24207 094 iD 55: 24237 094
---------------	--------------------------------------	-------------	--------------------------------------	--------------	--------------------------------------

iD Inspiration 55-70

Twine

50 x 50 cm

Light Grey	Medium Grey	Blue Grey	Purple
iD 70: 24207 038 iD 55: 24237 038	iD 70: 24207 039 iD 55: 24237 039	iD 70: 24207 041 iD 55: 24237 041	iD 70: 24207 045 iD 55: 24237 045

Twine

50 x 50 cm

Turquoise	Denim	Indigo	Dark Grey
iD 70: 24207 042 iD 55: 24237 042	iD 70: 24207 043 iD 55: 24237 043	iD 70: 24207 044 iD 55: 24237 044	iD 70: 24207 040 iD 55: 24237 040

Metal Frame

50 x 50 cm

Rose	Platinum	Aluminium	Stainless
iD 70: 24207 078 iD 55: 24237 078	iD 70: 24207 079 iD 55: 24237 079	iD 70: 24207 080 iD 55: 24237 080	iD 70: 24207 081 iD 55: 24237 081

iD Inspiration 55-70

FEATURE STRIP COLOURS

Create visual effects with contrasts of colours to highlight interior features, shape perceptions of a room size or personalise your flooring design.

BLACK	1421 001	RED	1421 010	TOBACCO	1421 008
DARK GREY	1421 009	COPPER	1421 012	SILVER	1421 002
ROYAL BLUE	1421 011	GOLD	1421 003	EGGSHELL	1421 013



Feature strips /Dark Grey, Red

iD Inspiration 40

iD Inspiration 40's versatile design and durability make it a great choice for commercial interiors. For hotels, offices and shops as well as aged-care environments, with light to moderate traffic.

White Oak / Light, Grey
20 x 122 cm

The optimum
design solution
for medium traffic
environments



iD Inspiration 40

DESIGN YOUR OWN FLOOR DECOR

Get creative with a carefully chosen range of 34 colours and patterns plus a variety of plank and tile formats.

ACCESSORY PACKAGE

- Compact skirting with decorative film and PUR surface treatment to match all 34 designs.
- All accessories for user safety, stairs and transitions.

HARD WEARING AND EASY CLEANING

Treated with Tarkett's unique TopClean XP coating, this hygienic surface strengthens and extends the life-cycle and simplifies cleaning and maintenance.

A SUSTAINABLE SOLUTION



Helps improve indoor air quality with VOC emissions below quantifiable levels, under $10\mu\text{g}/\text{m}^3$ after 28 days (100 times lower than Europe's strictest standards).



Phthalate-free technology based on alternative plasticizers.



100% recyclable & composed of 36% of recycled components.



Made in Germany to benefit from our best-in-class industrial expertise.

iD Inspiration 40

Antik Oak



Modern Oak



Brushed Pine

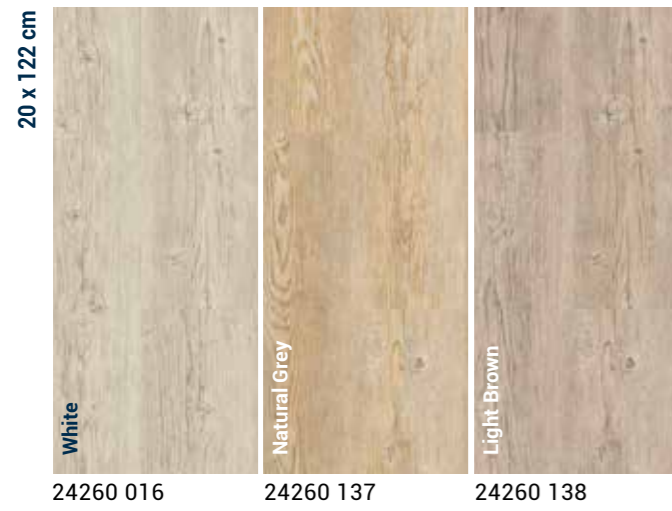

Large Beech



Patina Ash



Soft Walnut



English Oak

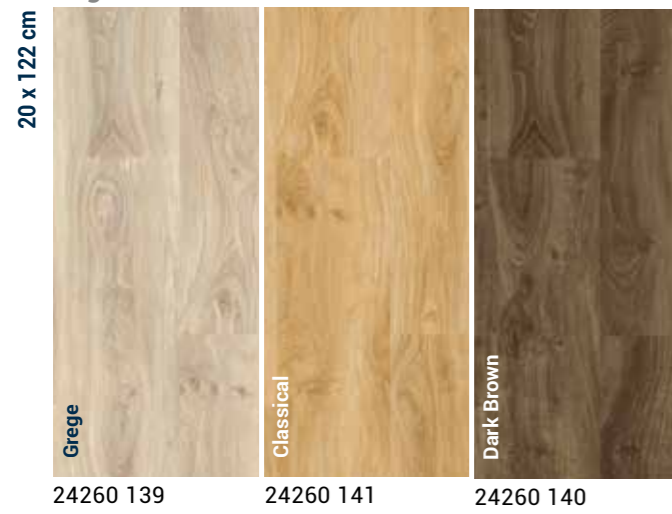

Maple



Rustic Oak



iD Inspiration 40

White Oak



Polished Concrete

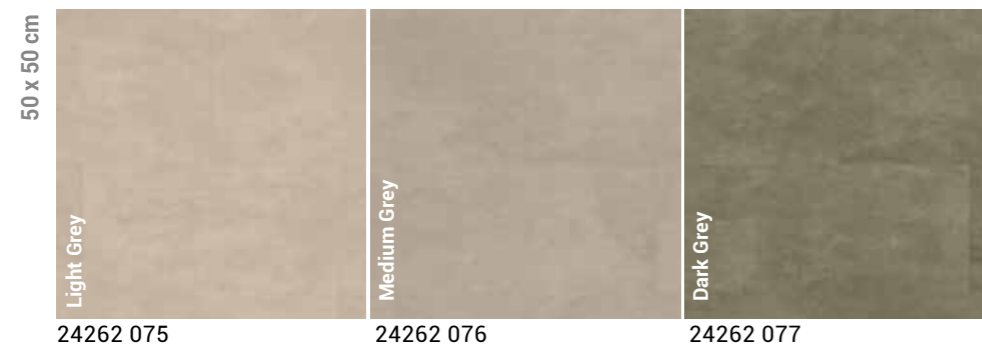

Rock



Vintage Zinc

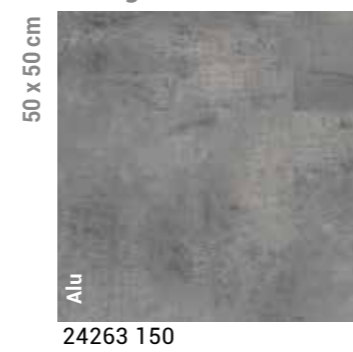

FEATURE STRIP COLOURS

Create visual effects with contrasts of colours to highlight interior features, shape perceptions of a room size or personalise your flooring design.

BLACK	1421 001	RED	1421 010	TOBACCO	1421 008
DARK GREY	1421 009	COPPER	1421 012	SILVER	1421 002
ROYAL BLUE	1421 011	GOLD	1421 003	EGGSHELL	1421 013



iD Essential 30

With 43 colours and 3 formats, iD Essential 30 is the best value for money. Mix and match wood, stones and metallic designs, while playing with colour shades. For commercial environments with light traffic.

Country Oak / Brown
22.9 x 121.9 cm

The simple
solution for
light traffic
environments





iD Essential 30

In the iD Essential 30 collection, 3 patterns and 12 different colours are available with embossing in register. This technique is used to create a precise texture that enhances a wood design. The surface is carved to match the natural essence of the wood, but unlike real wood, the surface interior does not absorb water and dirt and can be easily cleaned.

GREAT DESIGN OPTIONS

- 43 colour options.
- Plank and tile formats that you can combine to compose your own flooring story.

GREAT RESISTANCE AND EASY CLEANING

Treated with Tarkett's unique TopClean XP coating, this hygienic surface strengthens and extends the life-cycle and simplifies cleaning and maintenance.

A SUSTAINABLE SOLUTION



Total VOC emissions are at least 10 times lower than Europe's strictest standards.

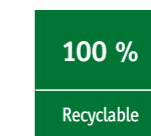

100% recyclable.



Phthalate-free technology based on alternative plasticizers.



The embossing in register technology is used to create a precise texture that enhances the wood design.

iD Essential 30



Cerused Oak



Aspen Oak



Beech



Country Oak



Primary Pine



Washed Pine



Smoked Oak



*Cerused oak decors offer a large variety of patterns so colours can significantly vary from one plank to the other within the same box.

iD Essential 30

Soft Oak



Original Slate

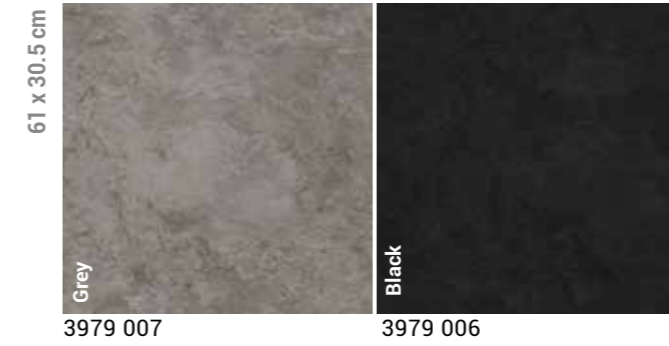

Soft Oak



Maple



Walnut



Sandstone

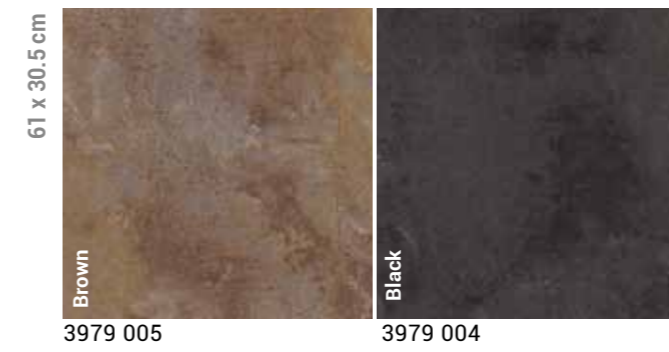

Scratched Metal



Venezia



Accessories for our Glue-down collections

SKIRTING

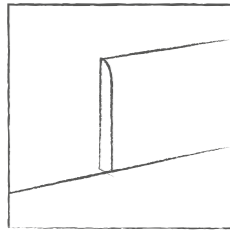

PVC DECORATIVE SKIRTING

Compact skirting with decorative film and PUR surface treatment to perfectly match selected designs
 📦 10 units of 2.02 lm (height = 6 cm)

Please refer to pages 107 to 113 for corresponding SAP codes

ACCESSIBILITY

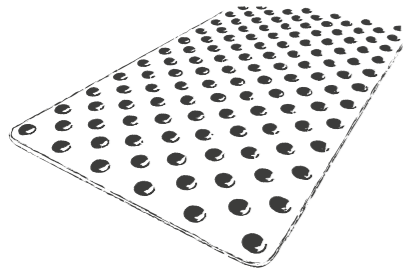

EASY KIT 3D STUDS

- Accessibility accessory
- Ready-to-use podotactile studs to be simply fitted on top of the existing floorcovering

- Grey 1440 551
- Black 1440 552
- 📦 5mm x 22.5mm for a 33 studs kit (8 kits per pack)

WARNING TILE

- Helps recognize a change in level, in accordance with regulatory requirements for disabled access and safety
- Self-adhesive or to be glued to the floorcovering (according to product), Format: 800 x 420 x 7mm

- 📦 1 box of 6 tiles
- White 1431 001
- Black 1431 002
- Light Grey 1431 003

- Self-adhesive rectangular tiles, Format: 815 x 420 x 8mm
- 📦 1 box of 10 tiles

- Self-adhesive square tiles, Format: 450 x 420 x 8mm
- 📦 1 box of 10 tiles

- White 1440 350 - 1440 450
- Grey 1440 351 - 1440 451
- Black 1440 352 - 1440 452
- Ivory 1440 353 - 1440 453
- Red 1440 354 - 1440 454
- Yellow 1440 355 - 1440 455

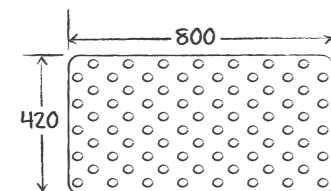

UNDERLAY

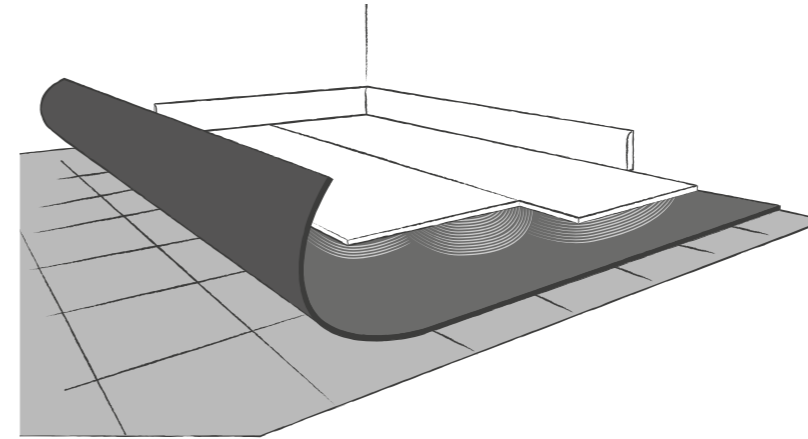

TARKOFLAT LOOSE-LAY

- Ready-to-use solution to reduce slight unevenness by up to 1.5mm depth
- Quick and easy-to-install solution
- Calendered PVC foil, loose-lay (naked)
- Grey 3568 004

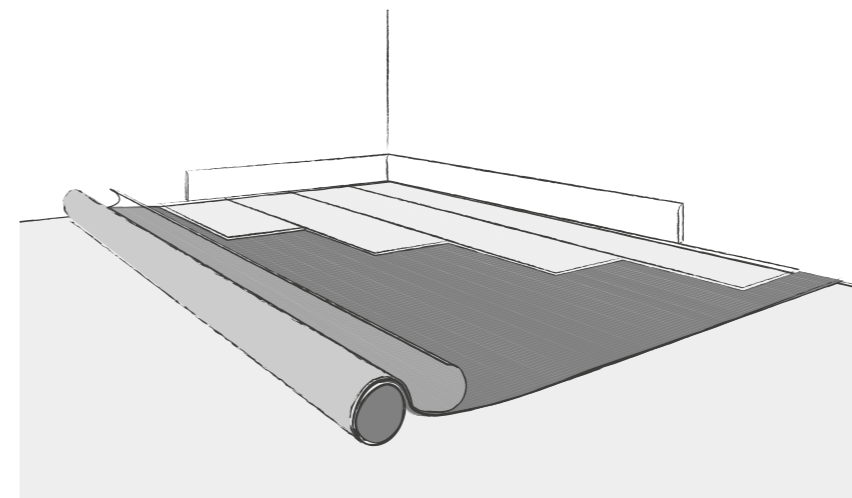

TARKOFLAT SELF-ADHESIVE

- Ready-to-use solution to reduce slight unevenness by up to 1.5 mm depth
- Quick and easy-to-install solution
- Environmentally-friendly solution (no adhesive needed)
- Grey 3569 004

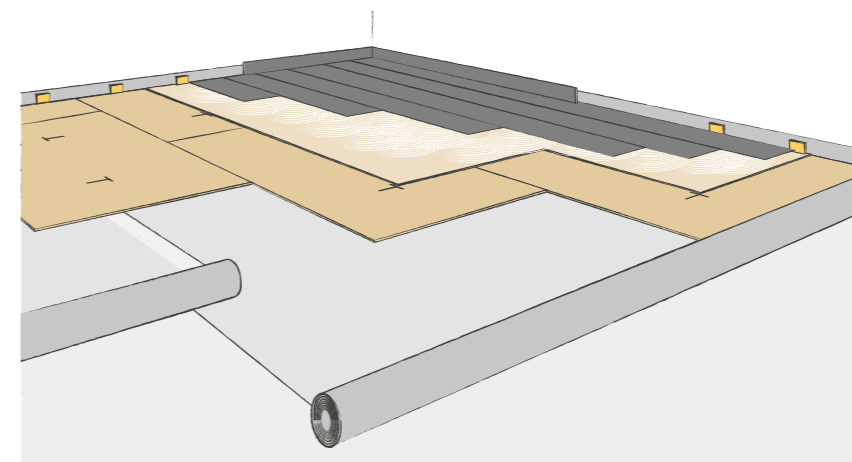

JUMPAX ORIGINAL®

- Levels existing subfloor perfectly via a ready-to-use, dual rigid-board floating system
- Reduces noise by up to 21dB Lw
- Provides greater resistance in heavy-traffic areas with its strong, rigid structure
- Beige 24993 010

*Tarkett recommends a selection of manufacturer adhesive (list available at: professionals.tarkett.com/content/list-recommended-adhesives). It is the responsibility of the adhesive manufacturer and flooring contractor to ensure the product being used is appropriate to use and applied in accordance with the manufacturer recommendations.

iD Click Ultimate

For an ultimate experience delivering ultimate results, Tarkett introduces an innovative class of hard surface flooring that combines the strength and feel of wood and stone with all the advantages of luxury vinyl tiles - the ultimate renovation solution!

Riviera Oak / Light Brown
17,6 x 121,3 cm

Renovating
has never been
so swift, aesthetic
and robust



iD Click Ultimate

ULTIMATE RESISTANCE

iD Click Ultimate covers large spaces and withstands high traffic.

The RCC technology guarantees that the product is wear-proof, stain-proof, heat-proof and waterproof!

ULTIMATE INSTALLATION

You can install this flooring directly over ceramic tiles and most existing subfloors. It is quick and easy to install thanks to I4F new click system which helps you minimise downtime.

ULTIMATE ACOUSTIC COMFORT

19dB sound absorption thanks to Soundblock technology.

ULTIMATE DESIGN

You can stroll through 15 modern and stylish realistic wood and stone designs. And don't miss out on the Plus Effect with Embossing in Register technology on most of our wood designs.

ULTIMATE THERMOSTABILITY

iD Click Ultimate maintains excellent dimensional stability in extreme temperature variations. No deformation over time from 10°C to 60°C.

A SUSTAINABLE SOLUTION



Total VOC emissions are at least 10 times lower than Europe's strictest standards.

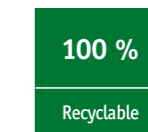

100% recyclable.



Phthalate-free technology based on alternative plasticizers.



The embossing in register technology is used to create a precise texture that enhances the wood design.

iD Click Ultimate

Stylish Oak



24775 002 24775 003 24775 001 24775 000

Light Oak



Soft Ash

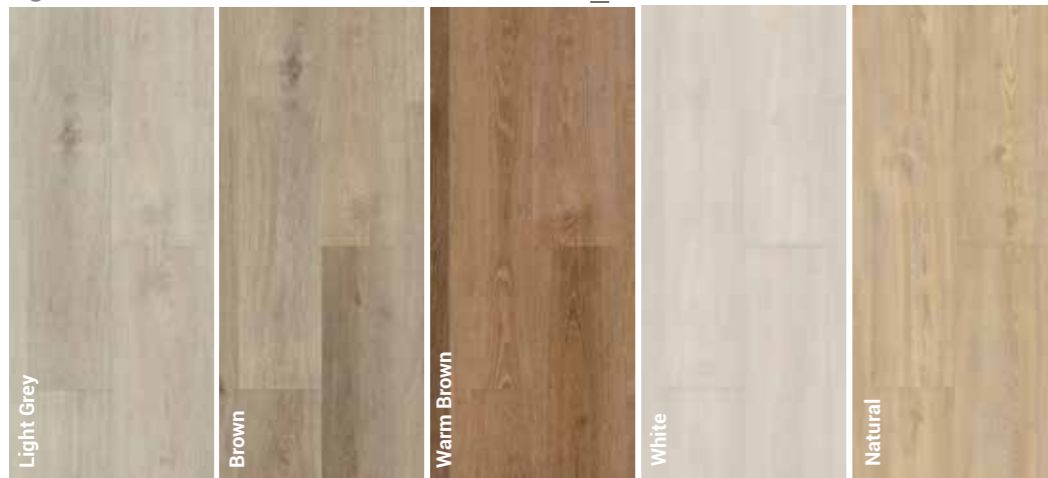

24775 013 24775 012 24775 014 24777 018 24777 019

Riviera Oak



Timeless Concrete



24775 015 24775 017 24775 016 24776 022 24776 021 24776 020

Accessories for iD Click Ultimate

SKIRTING

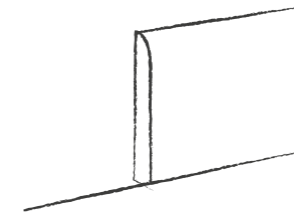

PVC DECORATIVE SKIRTING

PVC Decorative Skirting with PUR surface treatment.

- White (6 cm) 26640700
 - With decorative film matching collection designs (8 cm)
 - 📦 10 units of 2.02 lm (height = 6 or 8 cm)
- Please refer to page 115 for corresponding SAP codes

PROFILE

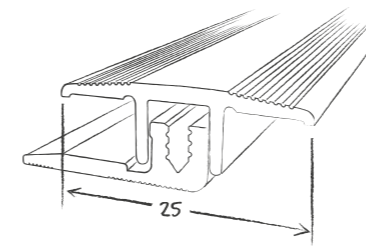

TRANSITION PROFILE

Very high traffic aluminium transition profile, to be screwed in

- Silver 1451 011
- Stainless Steel 1451 012
- 📦 10 units of 2.7 lm

ACCESSIBILITY

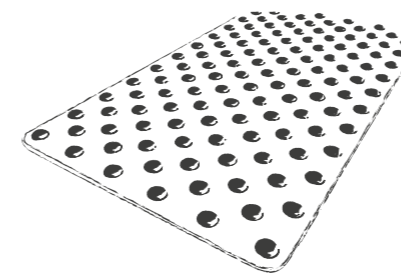

EASY KIT 3D STUDS

- Accessibility accessory
- Ready-to-use podotactile studs to be simply fitted on top of the existing floorcovering
- Grey 1440 551
- Black 1440 552
- 📦 5mm x 22.5mm for a 33 studs kit (8 kits per pack)

iD Inspiration Click

The iD Inspiration Click range features a refined palette of expressive wood textures. The motifs on all 20 designs were exclusively created to match the natural essence of wood.

Rustic Oak / Dark Grey
19.05 x 121.10 cm

The timeless designs for moderate to high traffic environments

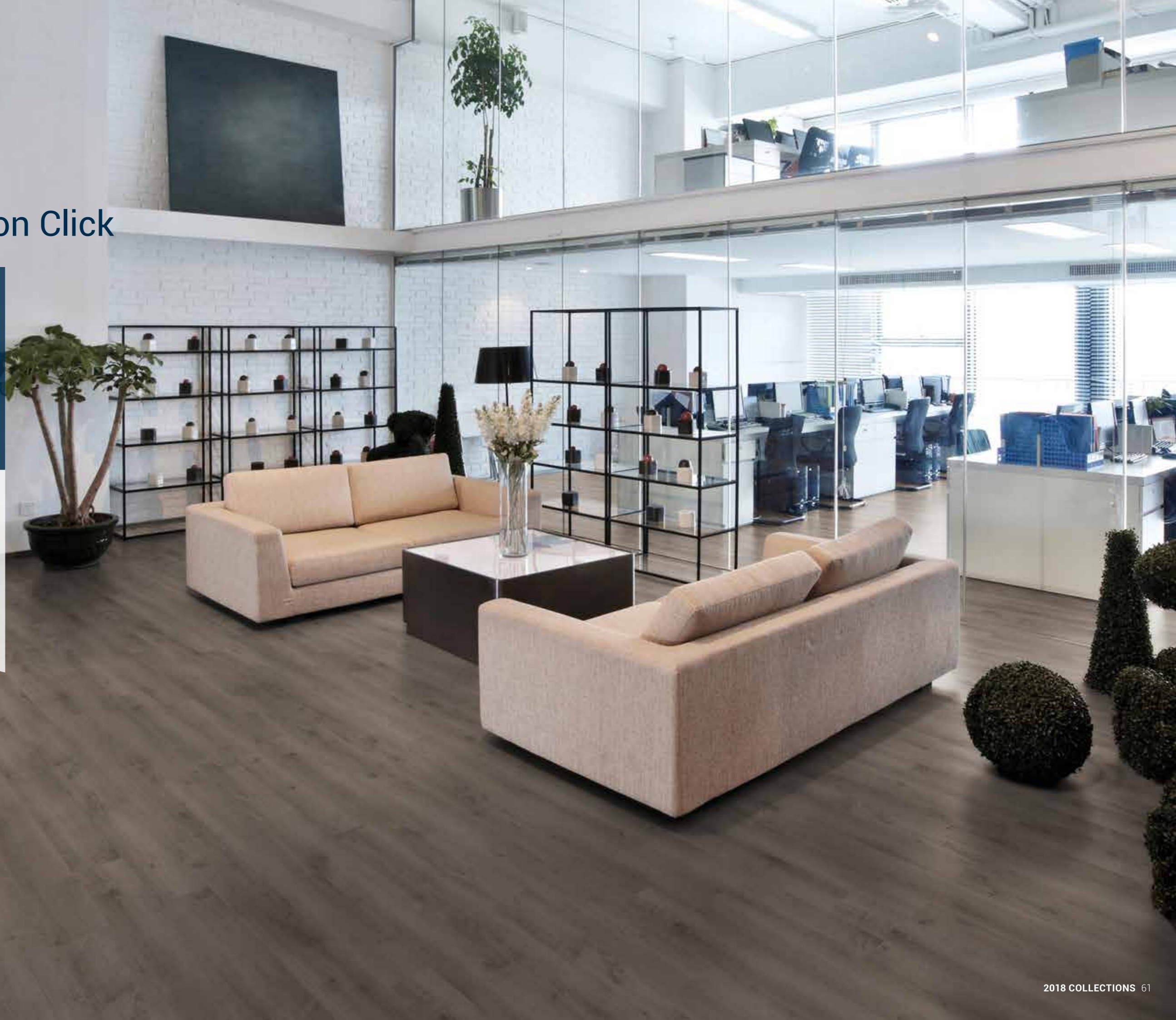



Rustic Oak / Dark Grey

iD Inspiration Click

iD Inspiration Click is an ideal solution for semi-commercial areas. It requires little to no subfloor preparation and can be installed over existing flooring. Its unique click system makes for a floating installation, without the need of glue, making installation 35% quicker than with glue-down products and 15% quicker than with other click systems*.

The iD Inspiration Click collection features 20 elegant colours that best express the latest trends.

CUSTOMISATION AVAILABLE

iD Inspiration offers 20 references and 3 formats with possible customisation of colours and bevels.

CLEANING

Treated with Tarkett's unique TopClean XP coating this hygienic surface strengthens and extends the life-cycle and simplifies cleaning and maintenance.

LIFE-LONG PERFORMANCE

- Highly resistant to the daily wear and tear of even the most demanding commercial areas.
- 10 years limited guarantee for commercial use and 20 years limited guarantee for residential use.

A SUSTAINABLE SOLUTION



Helps improve indoor air quality with VOC emissions below quantifiable levels, under $10\mu\text{g}/\text{m}^3$ after 28 days (100 times lower than Europe's strictest standards).



100% recyclable and composed of 36% of recycled components.



Phthalate-free technology based on alternative plasticizers.



Made in Europe to benefit from our best-in-class industrial expertise.

*Estimation - not binding

iD Inspiration Click

Contemporary Oak



Terrazzo

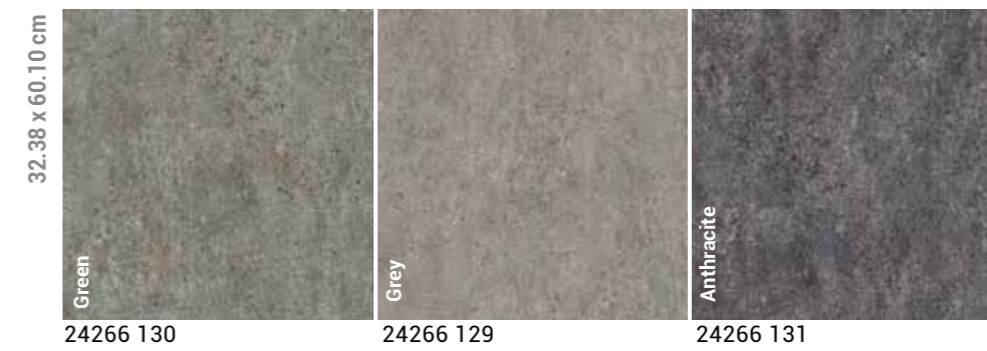

Elm



Patina Ash



Oxide

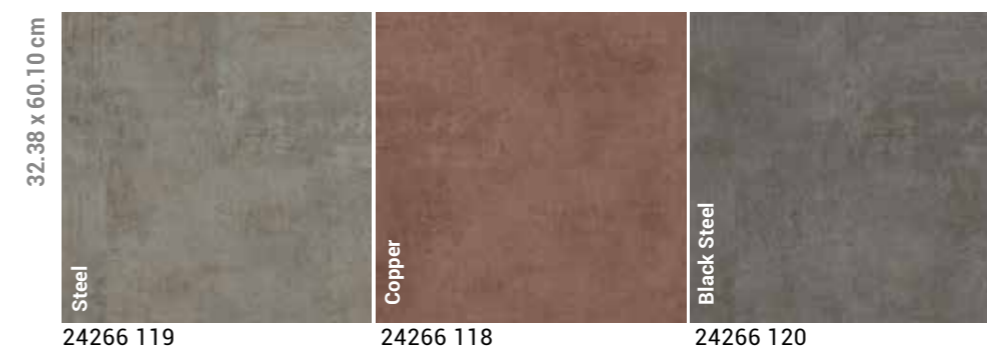

Patina Ash



Rustic Oak



iD Inspiration Click^{PLUS}

In retail, hospitality and work environments, design makes a first impression of how people experience the space. Today with PLUS, add another dimension to the flooring by amplifying it with textures that bestow a look and feel close to the real thing.

Lime Oak / Grege^{PLUS}
19.05 x 121.1 cm

Highlight the texture with Plus

L'annon à l'atée	5,5€	Jonest	3€	Les ambrées	3,5€	Viognier	4,5€
L'annon à l'atée	4,5€	Strop	3€	Divine	4,5€	ROSE	
SUIVTS		Laison Dupont	4€	La corne du bois des pendues	4,5€	Éros Catus de Looscoigne	
à la classique	1,0€	Quentine	4€	des grandes	5€		
à la (2000 / 20€)	1,0€	Tanan Boulba	4,5€	Geuze BOON	5€		
à la (10€ / 1000)	1,0€	Stouillen Lourd Cu	4,5€	Bon vœux	5€		
à la (10€ / 1000)	1,0€	de Brognarde	5,0€	Stefmans pure brut	5€		
à la (10€ / 1000)	1,0€	Leon Loupp	5,0€				
Bos...	3€						
Bonade...	3€						
à la (10€ / 1000)	3,5€						



iD Inspiration Click^{PLUS}

iD Inspiration Click^{PLUS} features designs with embossing in register. This technique is used to create a precise texture that enhances wood and stone designs. The surface is carved to match the natural essence of the material, but unlike real wood and stone, the grooves do not absorb water nor dirt and can therefore be easily cleaned.

CUSTOMISATION AVAILABLE

iD Inspiration offers 22 references and 4 formats with possible customisation of colours and bevels.

CLEANING

Treated with Tarkett's unique TopClean XP coating this hygienic surface strengthens and extends the life-cycle and simplifies cleaning and maintenance.

LIFE-LONG PERFORMANCE

- Highly resistant to the daily wear and tear of even the most demanding commercial areas.
- 10 years limited guarantee for commercial use and 20 years limited guarantee for residential use.

A SUSTAINABLE SOLUTION



Helps improve indoor air quality with VOC emissions below quantifiable levels, under 10µg/m³ after 28 days (100 times lower than Europe's strictest standards).



100% recyclable and composed of 36% of recycled components.



Made in Europe to benefit from our best-in-class industrial expertise.



Phthalate-free technology based on alternative plasticizers.



The embossing in register technology is used to create a precise texture that enhances the wood and stone designs.

iD Inspiration Click^{PLUS}



Lime Oak



Legacy Pine



Lime Oak

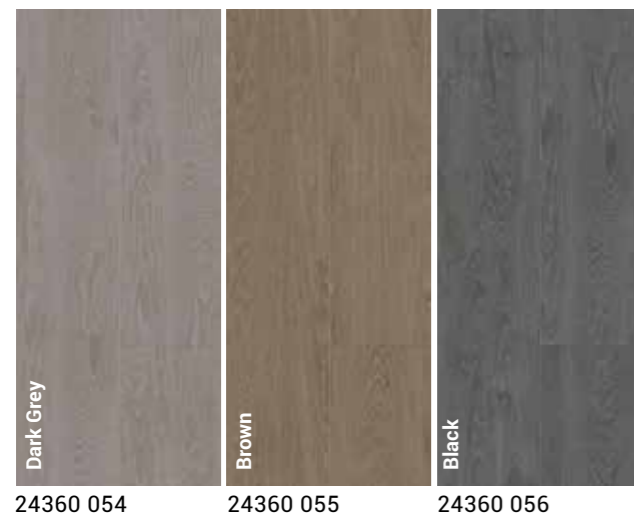

Rough Concrete

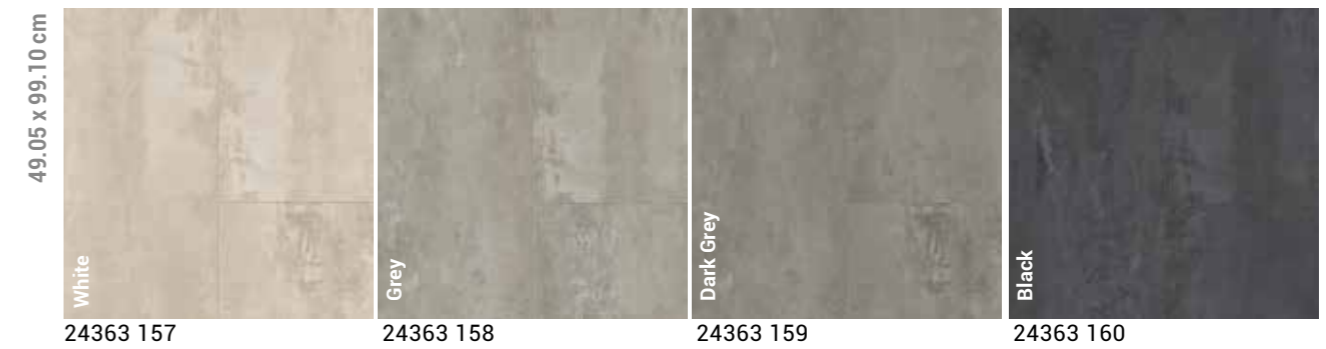

Alpine Oak

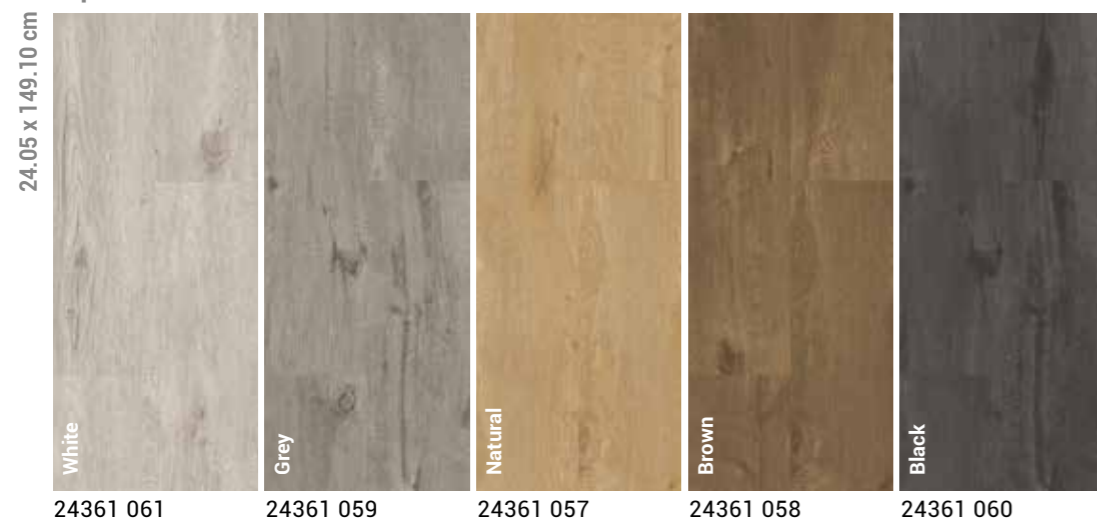

iD Essential Click

Express yourself through flooring design with 8 versatile and amazing colours from the iD Essential Click collection. You can also add a 19dB impact sound reduction acoustic underlay for more at-home comfort.

Limewashed Oak / Beige
Delicate Oak / Natural
18.3 x 122 cm

The swift
solution for
light traffic
environments



iD Essential Click

iD Essential Click is the ideal solution for new build and renovation in domestic environments. It requires no or little subfloor preparation and can even be installed on some existing flooring. Its click system allows a floating installation, avoiding the use of glue, making the installation 20% quicker than with glue-down products*.

Future renovations are also easier and cheaper as the product can be removed with no damage to the subfloor. With Tarkomfort Premium underlay, your iD Essential Click flooring will benefit from a 19dB acoustic sound reduction.

iD ESSENTIAL CLICK FINISHING TOUCH

- Easy and rapid installation is matched by a permanent hold for a long-lasting solution.
- Comes with a complete range of accessories for user safety and efficient installation and project completion.

GREAT RESISTANCE AND EASY CLEANING

Treated with Tarkett's unique TopClean XP coating this hygienic surface strengthens and extends the life-cycle and simplifies cleaning and maintenance.

A SUSTAINABLE SOLUTION



Total VOC emissions are at least 10 times lower than Europe's strictest standards.

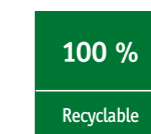

100% recyclable.



Phthalate-free technology based on alternative plasticizers.

*Estimation - not binding

Limewashed Oak / Beige
Delicate Oak / Natural

iD Essential Click

Delicate Oak



24722 002

Limewashed Oak



24722 000

24722 001

Toasted Oak



24722 003

24722 004

Rust Metal



24723 001

24723 002

Stone



24723 000

Accessories for our Click collections

SKIRTINGS

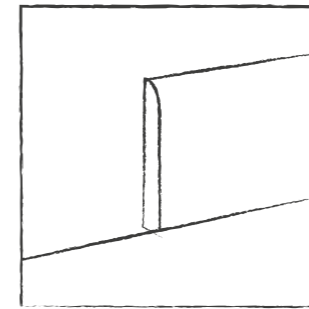

PVC DECORATIVE SKIRTING

Compact skirting with decorative film and PUR surface treatment to perfectly match all designs
 📦 10 units of 2.02 lm (height = 6 cm)

Please refer to pages 117 to 121 for corresponding SAP codes

PROFILES

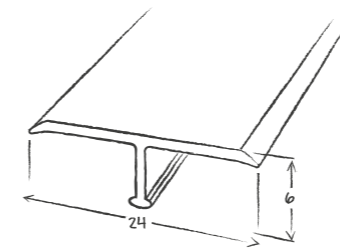

TRANSITION PROFILE - GENERAL TRAFFIC

General traffic aluminium transition strip, to be screwed in

- Silver 1451 021
 - Stainless Steel 1451 022
- 📦 10 units of 2.7 lm

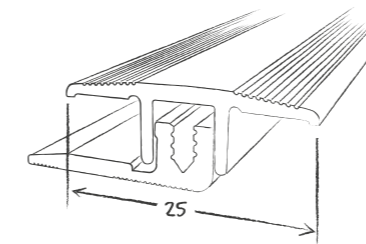

TRANSITION PROFILE - VERY HIGH TRAFFIC

Very high traffic aluminium transition profile, to be screwed in

- Silver 1451 011
 - Stainless Steel 1451 012
- 📦 10 units of 2.7 lm

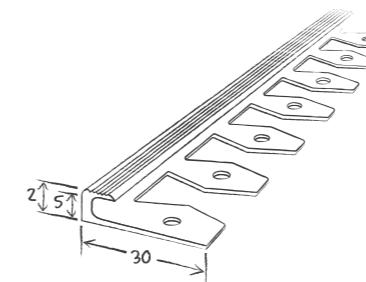

BENDABLE PROFILE

Aluminium stop profile, to be screwed in

- Silver 1456 011
 - Stainless Steel 1456 012
- 📦 10 units of 2.5 lm

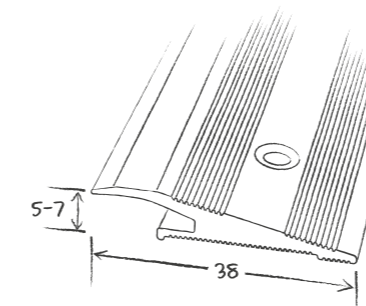

RAMP PROFILE

Aluminium ramp profile, to be screwed in

- Silver 1454 011
 - Stainless Steel 1454 012
- 📦 10 units of 2.7 lm

Accessories for our Click collections

ACCESSIBILITY

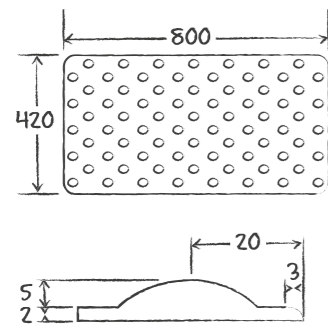
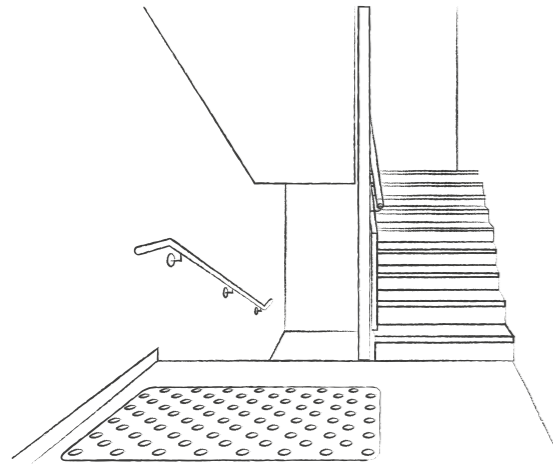

WARNING TILE

- Helps recognize a change in level, in accordance with regulatory requirements for disabled access and safety
- Self-adhesive or to be glued to the floorcovering (according to product), Format: 800 x 420 x 7mm
- 📦 1 box of 6 tiles
- White 1431 001
- Black 1431 002
- Light Grey 1431 003
- Self-adhesive rectangular tiles, Format: 815 x 420 x 8mm
- 📦 1 box of 10 tiles
- Self-adhesive square tiles, Format: 450 x 420 x 8mm
- 📦 1 box of 10 tiles
- White 1440 350 - 1440 450
- Grey 1440 351 - 1440 451
- Black 1440 352 - 1440 452
- Ivory 1440 353 - 1440 453
- Red 1440 354 - 1440 454
- Yellow 1440 355 - 1440 455

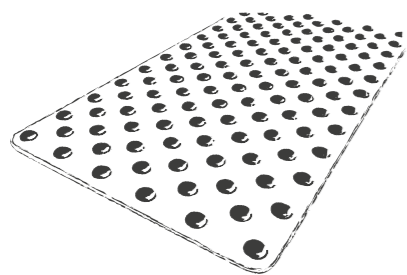

EASY KIT 3D STUDS

- Accessibility accessory
- Ready-to-use podotactile studs to be simply fitted on top of the existing floorcovering
- Grey 1440 551
- Black 1440 552
- 📦 5mm x 22.5mm for a 33 studs kit (8 kits per pack)

UNDERLAY

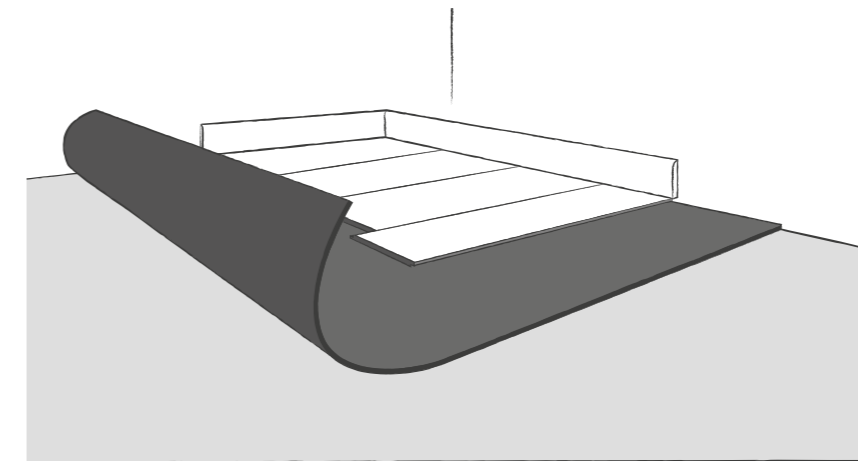

TARKOMFORT PREMIUM

- Provides high-impact sound reduction of up to 19dB and in-room noise reduction (72dB)
- Black 24992 030
- 📦 1 roll of 1m x 15m

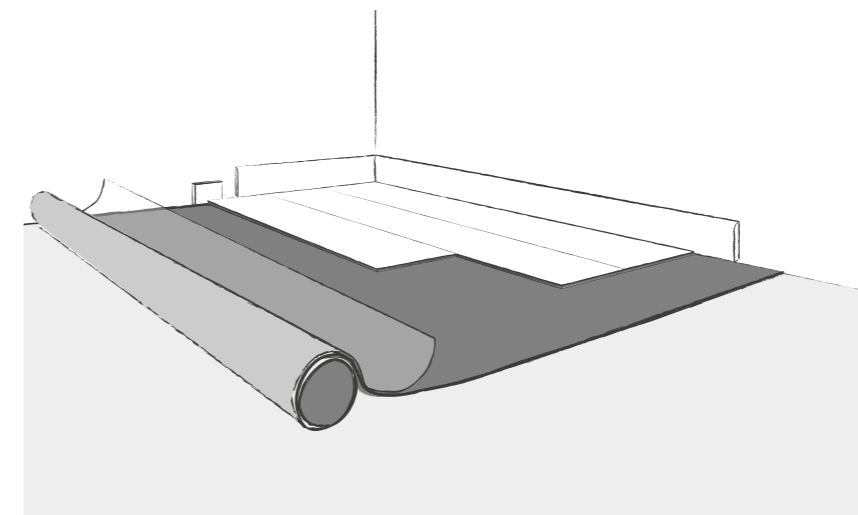

TARKOMFORT PRO

- Acoustic Performance**
- Powerful acoustic insulation, reducing both impact sound and in-room noise (13dB)
- Quick and easy to install
- Woven anti-slip surface to grip floor covering
- Brown 2499 2020

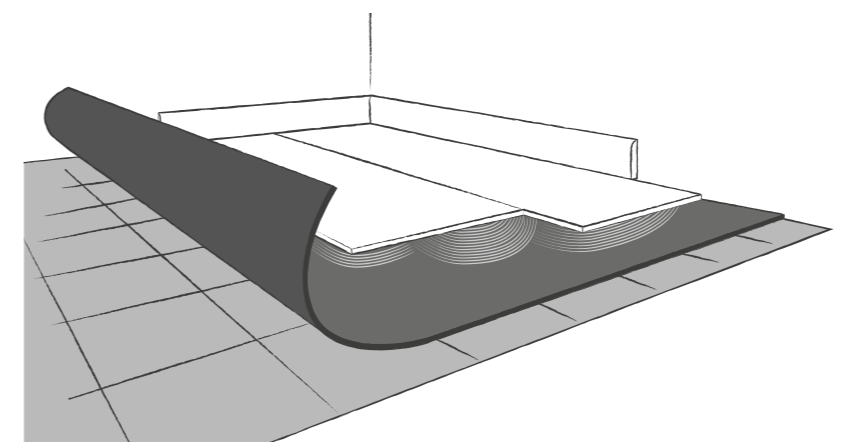

TARKOFLAT LOOSE-LAY

- Ready-to-use solution to reduce slight unevenness by up to 1.5mm depth
- Quick and easy-to-install solution
- Calendered PVC foil, loose-lay (naked)
- Grey 3568 004

*Tarkett recommend a selection of manufacturer adhesive (list available at: professionals.tarkett.com/content/list-recommended-adhesives). It is the responsibility of the adhesive manufacturer and flooring contractor to ensure the product being used is appropriate to use and applied in accordance with the manufacturer recommendations.

iD Inspiration Loose-Lay

Take a look at the iD Inspiration Loose-lay collection with its unique herringbone anti-skid technology that provides stronger plank adherence and stability than other modular vinyl solutions. It also lets you mix and match from a wealth of great designs.

Saw Oak / Grey
22.9 x 121.9 cm

Combine fast
and versatile
installation with
timeless designs



iD Inspiration Loose-Lay

iD Inspiration Loose-lay is up to three times faster to install than other modular vinyl solutions*, making it ideal for small or occupied surfaces, or environments requiring fast installation. It even makes overnight renovation possible. It requires no or little subfloor preparation, as it absorbs uneven patches, and no glue** for installation. iD Inspiration Loose-lay's anti-skid backing is unique. Its patented herringbone design and pattern ensures strong plank adherence and stability.

A UNIQUE LAYING TECHNOLOGY FOR FAST AND COST-SAVING INSTALLATIONS

- 2.5 times higher adherence than its competitors***.
- Total dimensional stability, and as durable and reliable as a glue-down flooring.
- Easily removable with no damage to the product or the subfloor.

A WIDE SELECTION OF EXCLUSIVE AND ULTRA-REALISTIC DESIGNS

- 22 refined designs in plank (19 wood essences) and tile (3 stone patterns) formats.
- Coordinated with Tarkett accessories: skirtings, transitions and profiles.

GREAT RESISTANCE AND LOW MAINTENANCE

Treated with Tarkett's unique TopClean XP coating this hygienic surface strengthens and extends the life-cycle and simplifies cleaning and maintenance

A SUSTAINABLE SOLUTION



Total VOC emissions at least 10 times lower than Europe's strictest standards.

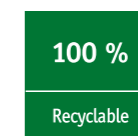

100% recyclable.



Phthalate-free technology based on alternative plasticizers.

iD Inspiration Loose-Lay

Beach Wood



Mountain Oak

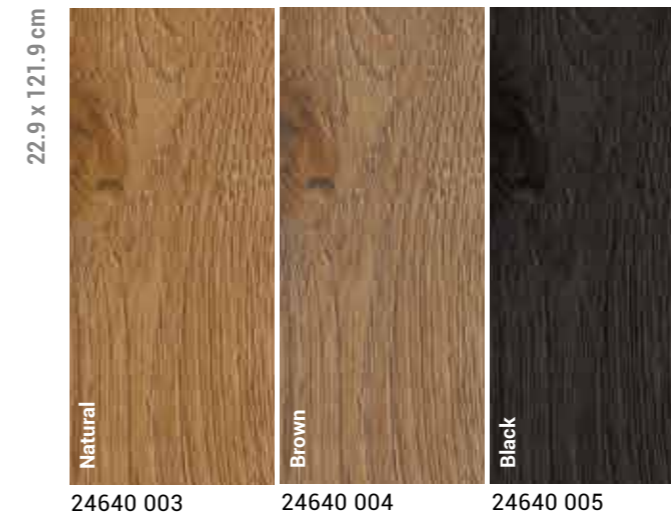

Christmas Pine

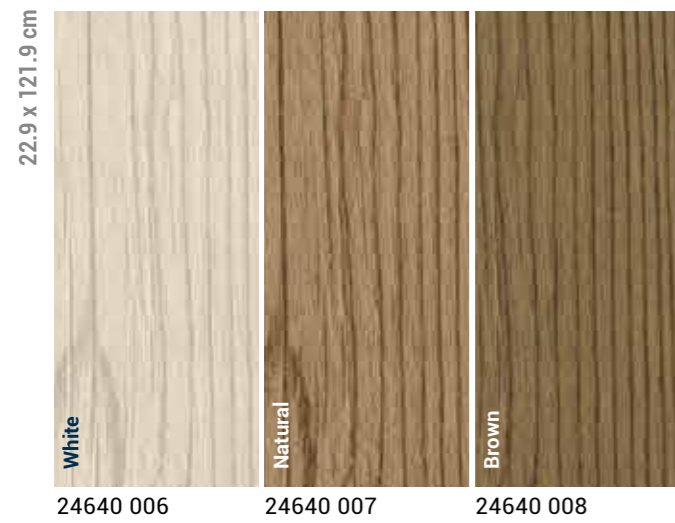

Delicate Wood



Sawn Oak



Elegant Oak



Limed Oak

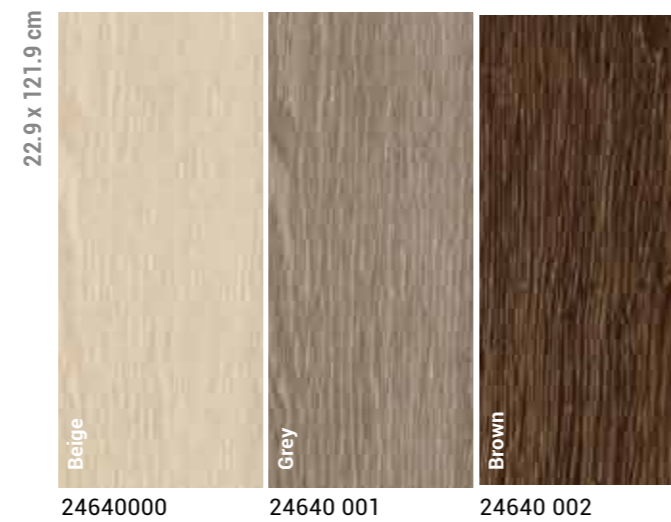

Béton



iD Square

Encourage efficiency at work by promoting one perfect team: comfort & well-being. For a calm and collaborative setting or a dynamic and inspiring space, you can find what you're looking for with this collection.

Dashes / Grey, Green, Purple
50 x 50 cm

Stimulate
ambiances and
gain easy access
to the underfloor





iD Square

iD Square is an acoustic Loose Lay with the largest variety of designs & colours on the market to create serene or more stimulating ambiances to reflect the image and values of your company. Its colours combine and coordinate to enhance zoning. This unique offer has 3 different formats: 50 x 50 cm for classic & timeless designs, 66 x 66 cm with modern designs and fewer joints for optimal aesthetic, 25 x 100 cm to play on multi-combinations.

EMPLOYEES COMFORT & WORK EFFECTIVENESS

- Better in-room acoustic with less sound transmission - ideal for working areas where concentration is needed.

EASY AND QUICK TO INSTALL & REMOVE

- Tackified offer: the flooring is easier to install and remove to ensure a tile replacement or to reach the subfloor.

GREAT RESISTANCE AND EASY CLEANING

- Specifically developed for the demanding heavy-traffic work environments.
- Resistant to spread of water & coffee stains and easy to keep clean.
- Treated with Tarkett's unique TopClean XP coating this hygienic surface strengthens and extends the life-cycle and simplifies cleaning and maintenance.

A SUSTAINABLE SOLUTION



Helps improve indoor air quality with VOC emissions below quantifiable levels, under $10\mu\text{g}/\text{m}^3$ after 28 days (100 times lower than Europe's strictest standards).

100 %

Recyclable

100% recyclable.



Phthalate-free technology based on alternative plasticizers.



Made in Europe to benefit from our best-in-class industrial expertise.

iD Square

Grid

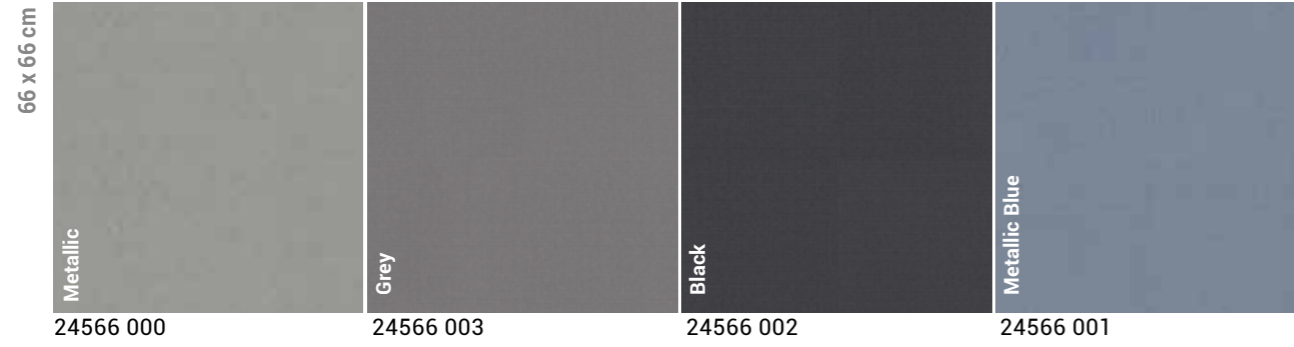

Dashes

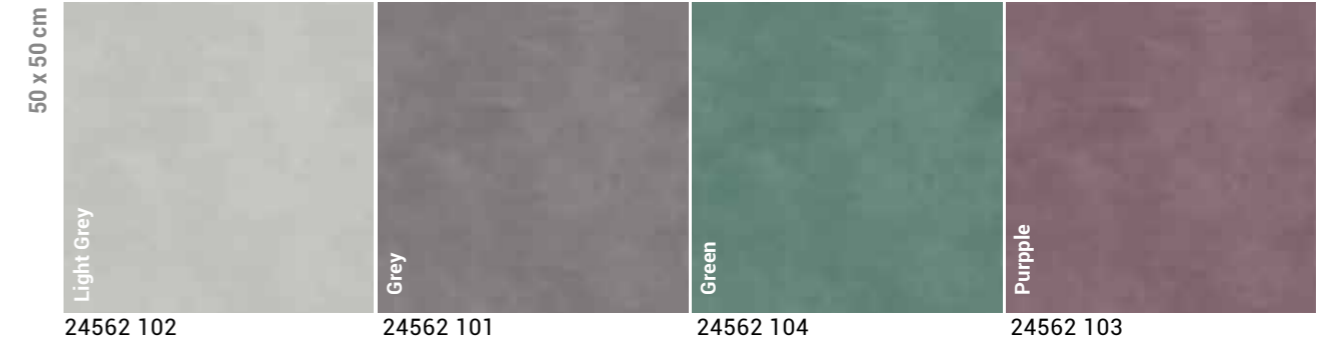

Vintage Zinc



Dashes



Patchwood

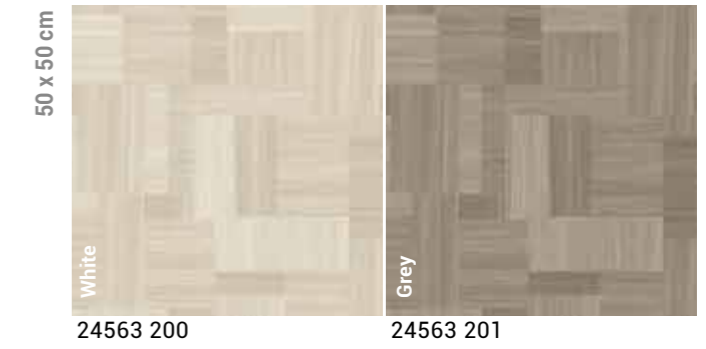

Vintage Zinc

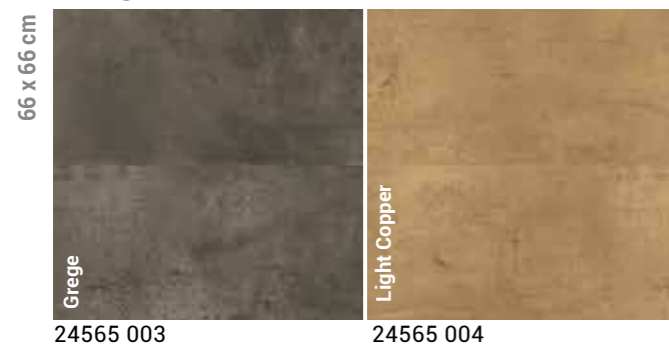

Fabrics

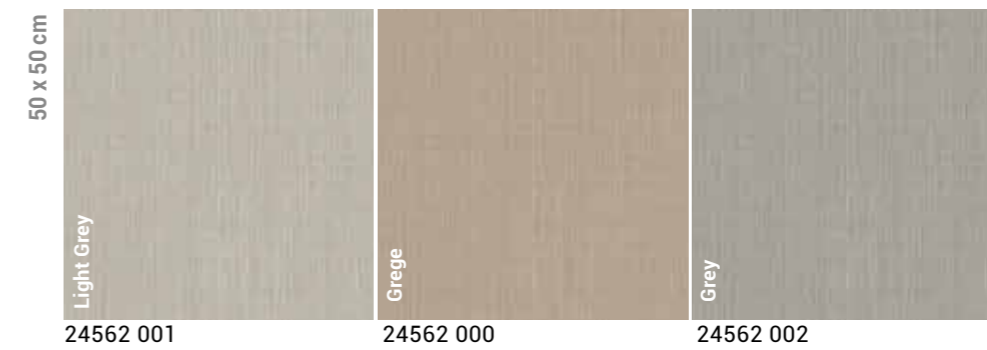

iD Square

Patchwork



Tisse

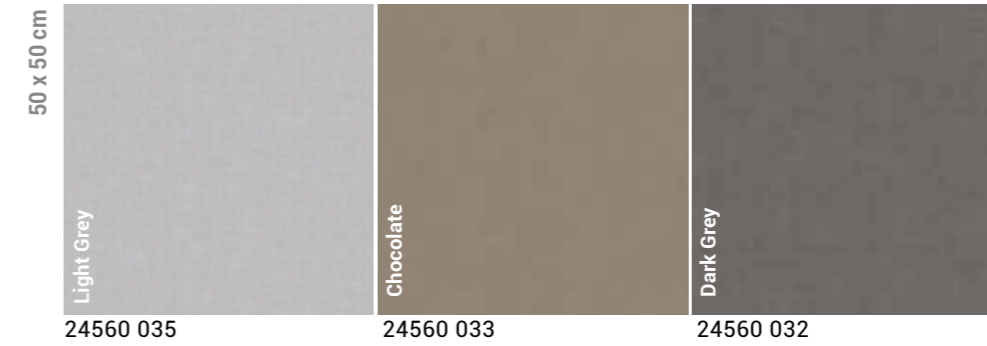

Patine

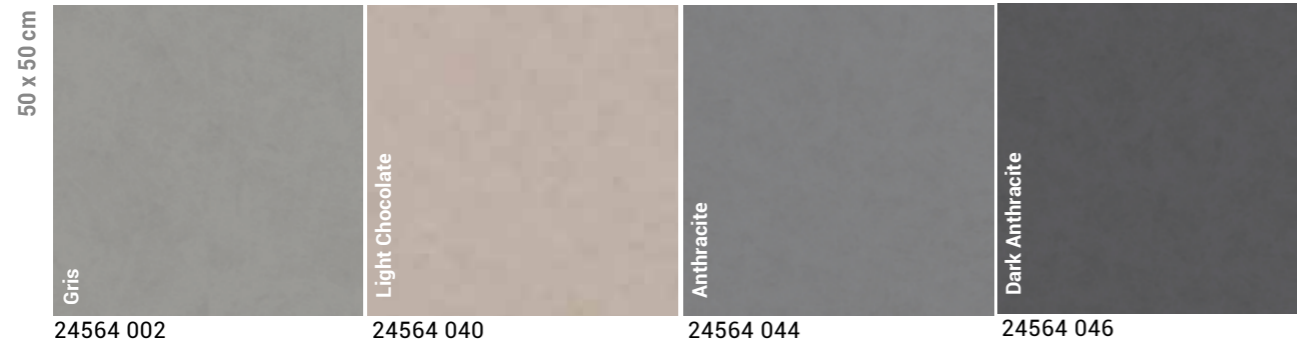

Zen

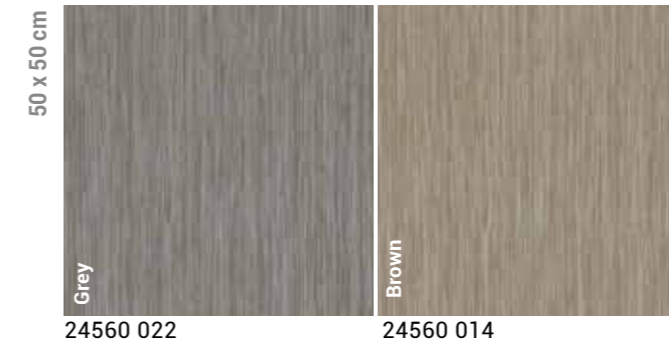

Patine

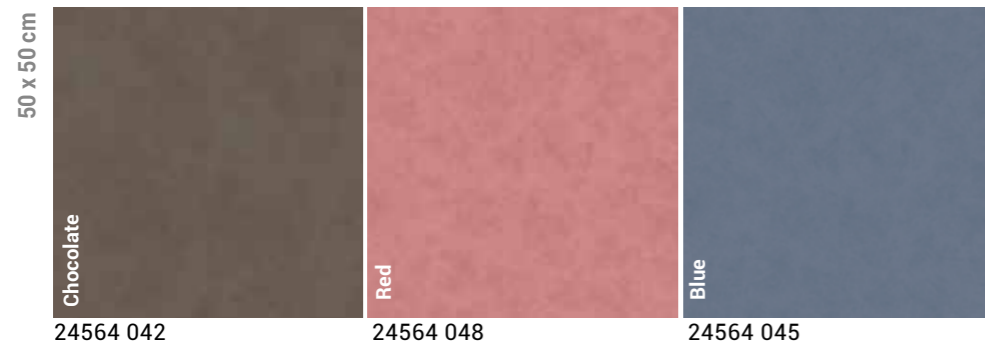

Minimal Wood

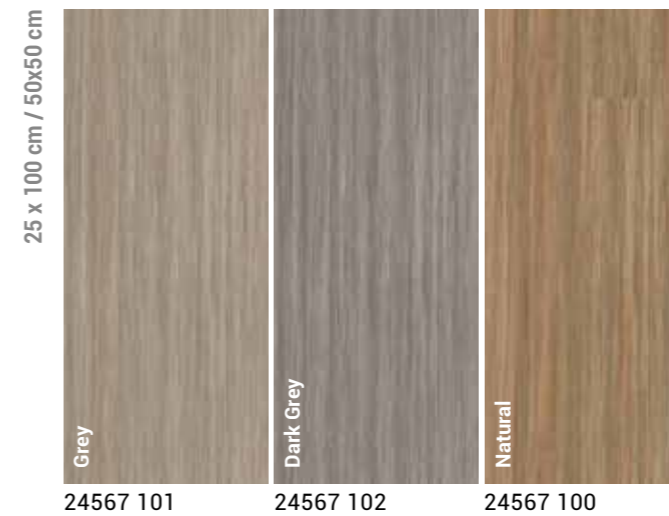

Plateau Ash



iD Tilt

Get tough with iD Tilt, the floor designed to meet your high traffic commercial and industrial needs. Even in heavy-traffic areas, flooring designs and layouts can enhance pathways or zoning and still be playful.

Concrete / Dark Grey
45.72 x 45.72 cm

The tough
flooring for high
traffic commercial
and industrial
environments



iD Tilt

iD Tilt is Tarkett's floating floorcovering solution designed for commercial or industrial applications in both new builds and renovation projects. Easy to install, it keeps installation time to a minimum and thereby reducing business losses due to construction downtime. Good value for money, iD Tilt saves you time and is an invaluable cost-saver on any construction project.

EASY TO INSTALL

- Limited subfloor preparation = time saved: 20% quicker than glue-down products.
- No glue required = cost & time savings: 10% lower installation costs.
- Your floor is immediately available for use = no loss of business: overnight installation.

EASY TO MAINTAIN

- Easy to remove & to renovate.
- No damage to subfloor.
- Easy to clean: TopClean XP™ surface treatment.

HELPS DEFINE SPACES

- Create shop in shop corners and demo areas.
- Directional signage.
- Delineate areas.

A SOLID CONSTRUCTION

- Suitable for high traffic areas.
- Very resistant interlocking system.
- Clean appearance.
- Long-lasting performance.

A SUSTAINABLE SOLUTION



Total VOC emissions are at least 10 times lower than Europe's strictest standards.

100 %

Recyclable

100% recyclable.



Phthalate-free technology based on alternative plasticizers.

iD Tilt

Concrete

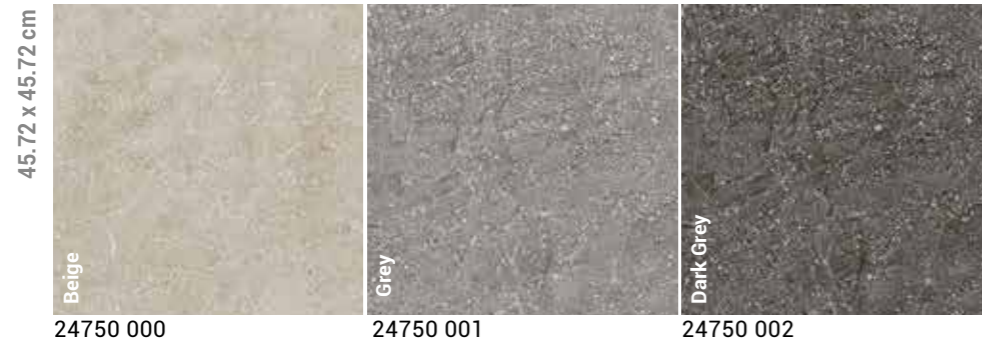

Granite

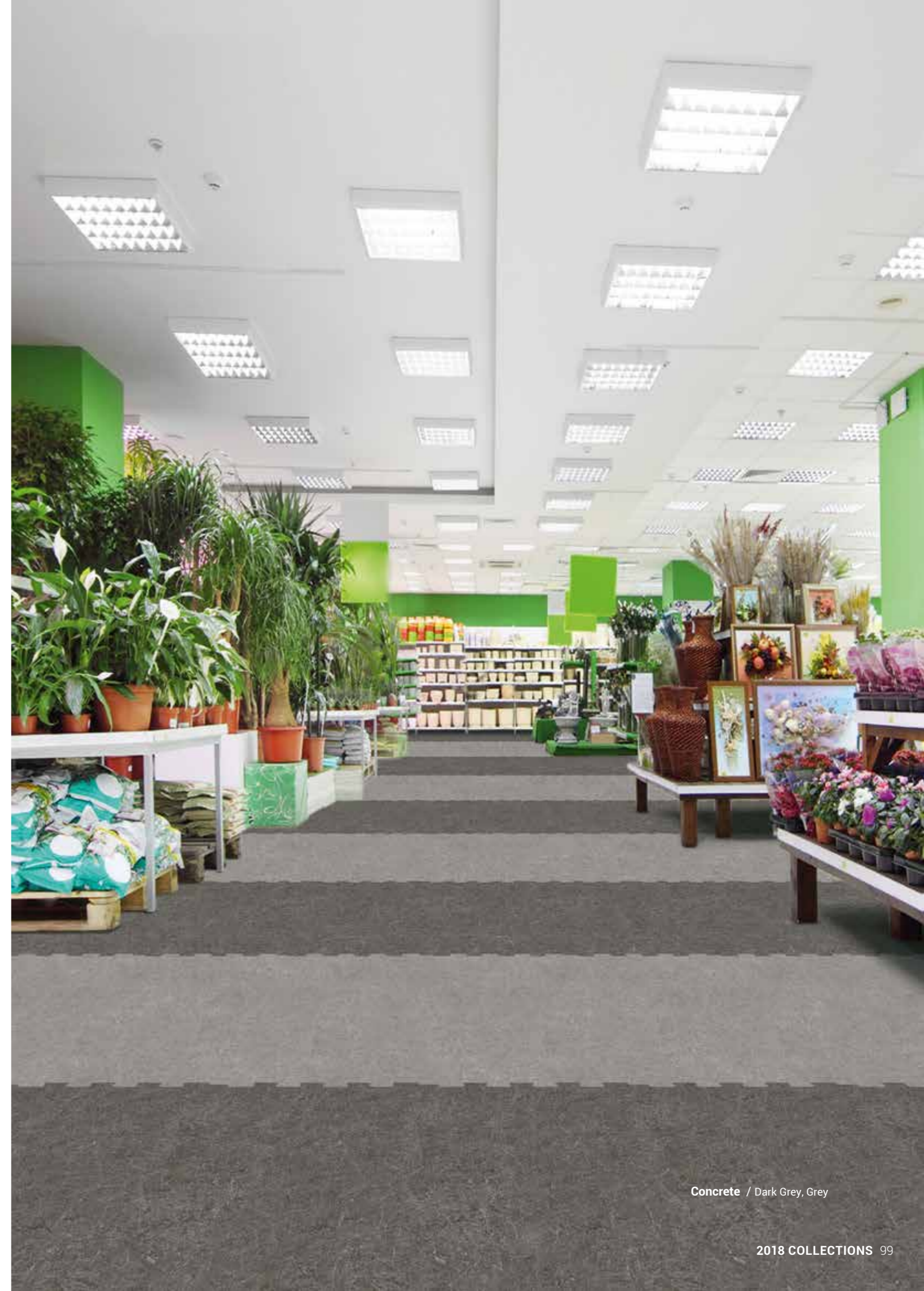
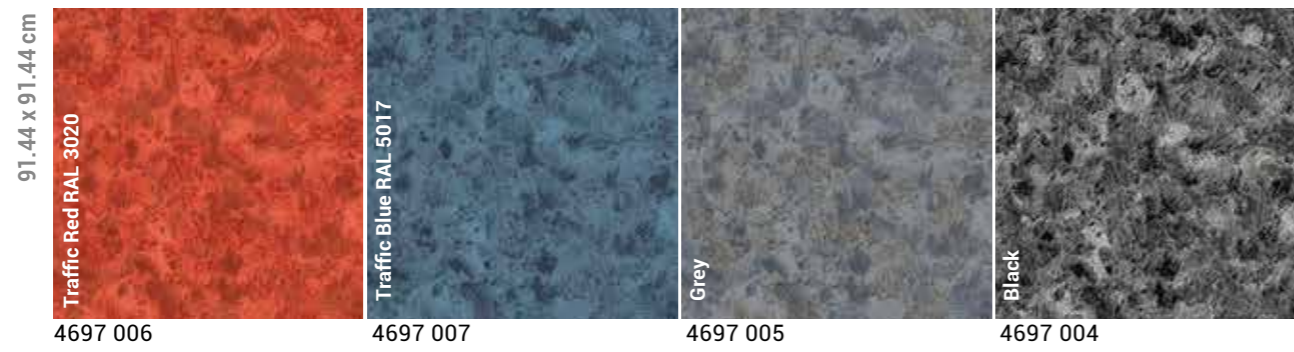

Concrete / Dark Grey, Grey

Accessories for our Loose lay collections

SKIRTING

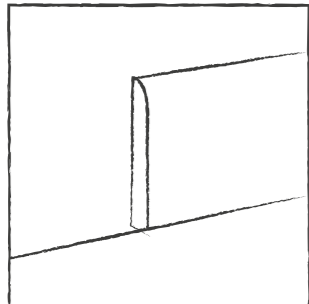

PVC DECORATIVE SKIRTING ID INSPIRATION LOOSE LAY

Compact skirting with decorative film and PUR surface treatment to perfectly match all designs
 📦 2.02 lm skirting in packs x 10

Please refer to page 123 for corresponding SAP codes

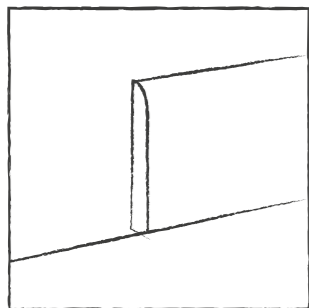

WALL BASE DECORATIVE SET-ON SKIRTING ID SQUARE & ID TILT

Compact skirting with decorative film and PUR surface treatment, to be glued

- White 26640 700
 - Aluminium 26640 701
- 📦 2.02 lm skirting in packs x 10

PROFILE

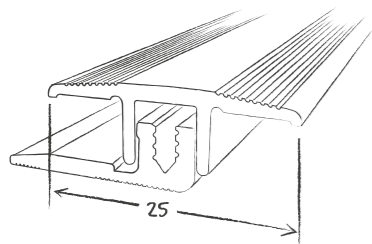

TRANSITION PROFILE

Very high traffic aluminium transition profile, to be screwed in

- Silver 1451 011
 - Stainless Steel 1451 012
- 📦 10 units of 2.7 lm

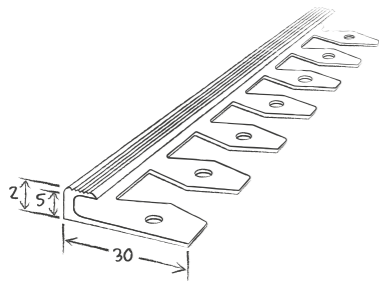

BENDABLE PROFILE

Aluminium stop profile, to be screwed in

- Silver 1456 011
 - Stainless Steel 1456 012
- 📦 10 units of 2.5 lm

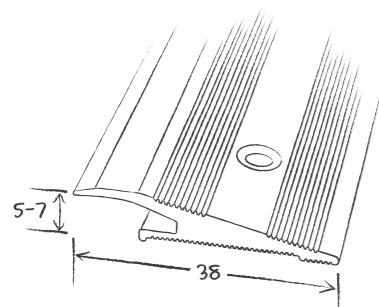

RAMP PROFILE

Very heavy traffic aluminium profile, to be screwed in

- Silver 1454 011
 - Stainless Steel 1454 012
- 📦 10 units of 2.7 lm

ACCESSIBILITY

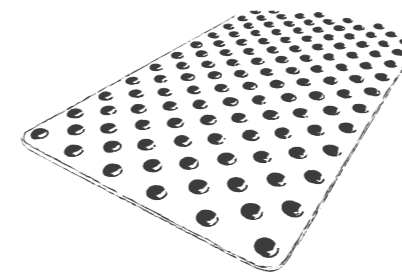
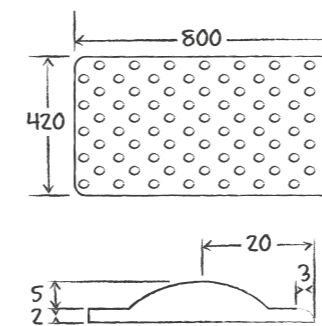
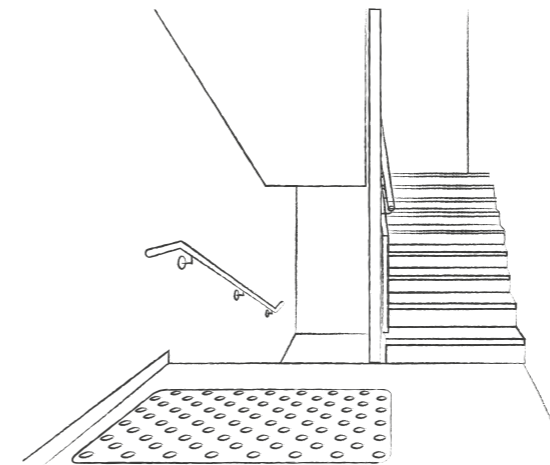

WARNING TILE*

- Helps recognize a change in level, in accordance with regulatory requirements for disabled access and safety
- Self-adhesive or to be glued to the floorcovering (according to product), Format: 800 x 420 x 7mm
- 📦 1 box of 6 tiles
- White 1431 001
- Black 1431 002
- Light Grey 1431 003
- Self-adhesive rectangular tiles, Format: 815 x 420 x 8mm
- 📦 1 box of 10 tiles
- Self-adhesive square tiles, Format: 450 x 420 x 8mm
- 📦 1 box of 10 tiles
- White 1440 350 - 1440 450
- Grey 1440 351 - 1440 451
- Black 1440 352 - 1440 452
- Ivory 1440 353 - 1440 453
- Red 1440 354 - 1440 454
- Yellow 1440 355 - 1440 455

EASY KIT 3D STUDS

- Accessibility accessory
- Ready-to-use podotactile studs to be simply fitted on top of the existing floorcovering
- Grey 1440 551
- Black 1440 552
- 📦 5mm x 22.5mm for a 33 studs kit (8 kits per pack)

UNDERLAY

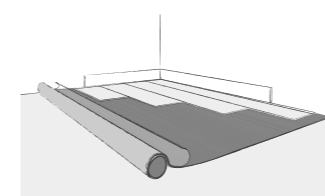

TARKOMFORT SELF-ADHESIVE

- High-class solution for reducing both impact sound and in-room noise
- Quick and easy-to-install solution
- Environmentally-friendly solution (90% natural raw materials)
- Black 24992 040

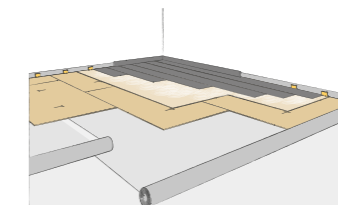

JUMPAX ORIGINAL®

- Levels existing subfloor perfectly via a ready-to-use, dual rigid-board floating system
- Reduces noise by up to 21dB Lw
- Provides greater resistance in heavy-traffic areas with its strong, rigid structure
- Beige 24993 010

*Caution: the area around the warning tiles will be merged together

Technical data iD Supernature & Tattoo

Certification & classification	Standards	iD Supernature & Tattoo	
Type of floor covering	EN ISO 10582	Heterogeneous Compact Resilient Floorcovering	
Classification	EN ISO 10874	Domestic: 23 Commercial: 34 Industrial: 43	
Technical characteristics			
Total thickness	EN ISO 24346	2,5 mm	
Wear layer thickness	EN ISO 24340	0,7 mm	
Total weight	EN ISO 23997	3950 g/m ²	
Wear layer binder content	EN ISO 10582	Type I	
Dimensions (minimum order quantity = 70m ²)	EN ISO 24342	Standard formats	
		Planks	
		10 x 50 cm	75 planks per box = 3,75 m ²
		16,66 x 100 cm	22 planks per box = 3,67 m ²
		12,5 x 122 cm	24 planks per box = 3,66 m ²
		20 x 122 cm	15 planks per box = 3,66 m ²
		Tiles	
		25 x 50 cm	30 tiles per box = 3,75 m ²
		50 x 50 cm (for stone designs only)	15 tiles per box = 3,75 m ²
		50 x 100 cm* (for stone designs only)	7 tiles per box = 3,5 m ²
		100 x 100 cm* (for stone designs only)	70 tiles per pallet
		100 x 150 cm* (for stone designs only)	47 tiles per pallet
		Special formats	
		Small Hexagon 20 x 23,094 cm	60 planks per box = 2,08 m ²
		Large Hexagon 33,33 x 38,486 cm	20 planks per box = 1,92 m ²
		Left & Right Herringbon 8,33 x 38,486 cm	80 planks per box = 2,56 m ²
Surface treatment (PUR)		Yes - TopCleanXP™	
Beveled edges		No	
Technical performances			
Dimensional stability	EN ISO 23999	≤ 0,10 %	
Curl resultant to heat	EN ISO 23999	≤ 2 mm	
Reaction to fire	EN 13501-1	B _n -s1 glued over concrete substrate B _n -s1 glued over wood substrate	
Residual indentation	EN ISO 24343-1	≤ 0,05 mm	
Furniture leg	EN 424	No damage	
Castor chair	ISO 4918 - EN 425	No damage	
Impact sound reduction	EN ISO 717-2	ΔL _w = 2 dB	
Reduction of in-room impact noise	EN ISO 31-074	Class C (L _{n,e,w} < 85 dB)	
Thermal resistance	EN ISO 10456	0,02 m ² K/W	
Light fastness	EN ISO 105-B02 (method 3a)	≥ 6	
Chemical resistance	EN ISO 26987	Not affected (0)	
Slip resistance	DIN 51130 EN 13893	R9 μ ≥ 0,30	
Electrical properties	EN 1815 EN 1081	<2 kV on concrete > 10 ⁹ Ohm	
Peeling resistance	EN ISO 24345	≥ 50N / 50mm	
Underfloor heating		Suitable - max. 27 °C	

The above information is subject to modification for the benefit of further improvement. (01/18).

Tarkett's instructions regarding installation, cleaning and maintenance should be observed. Please contact Tarkett at the address shown for these instructions.

CUSTOMS TARIFF : 4820 5000 00



Formats

iD Supernature

Wood designs

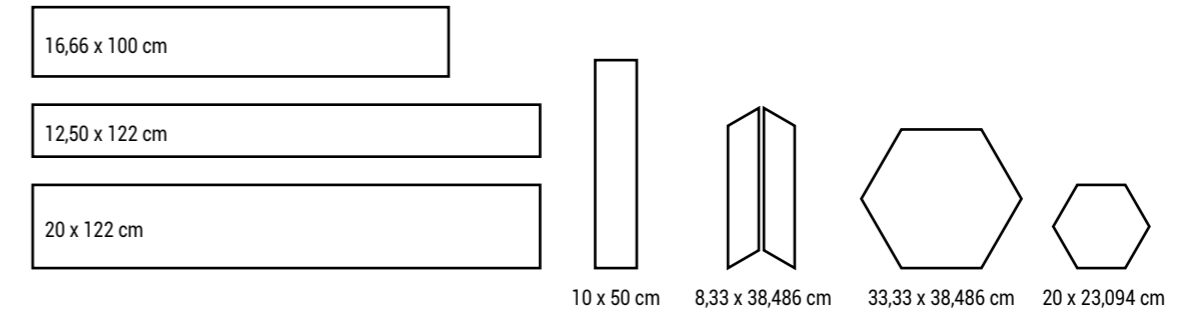

Stone designs

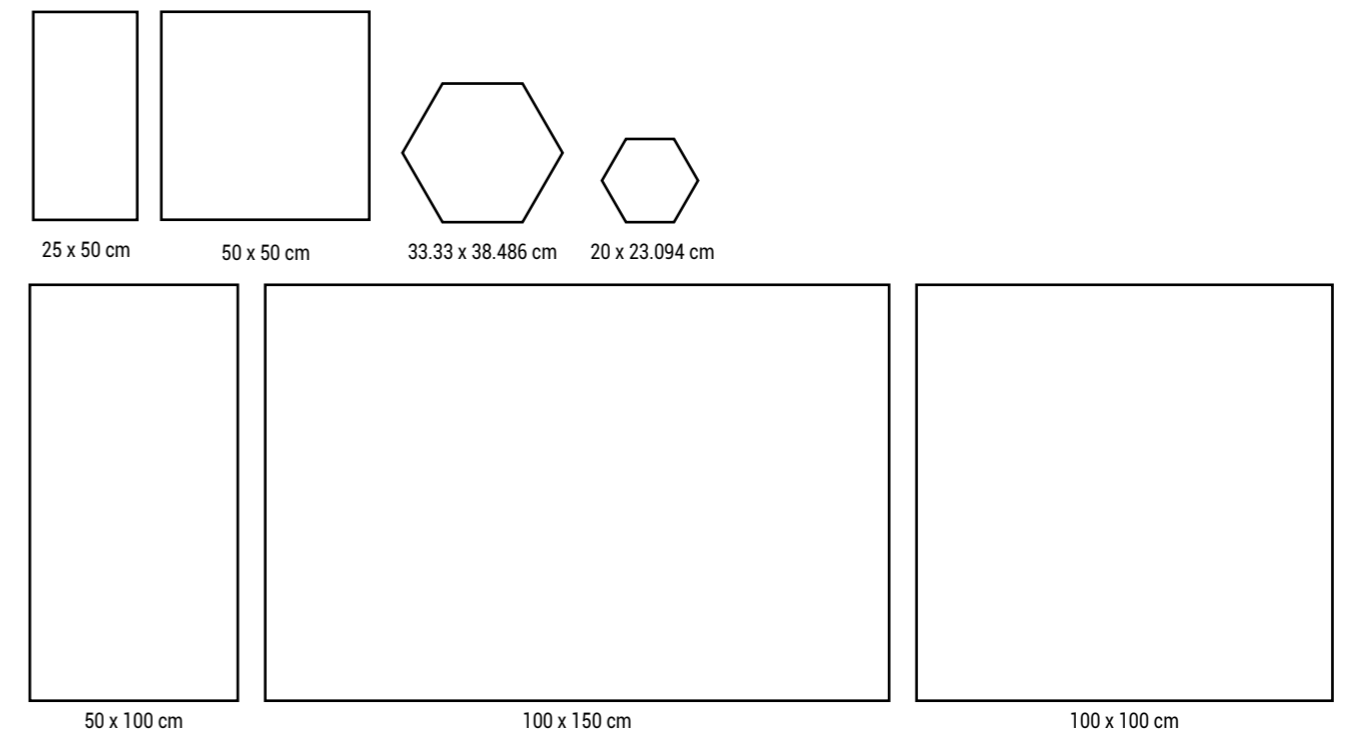

iD Tattoo

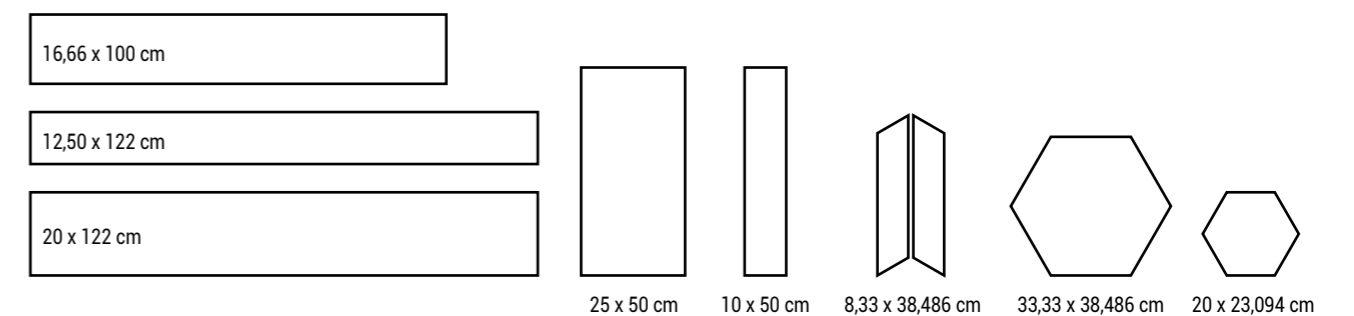

Technical data iD Mixonomi

Certification & classification	Standards	iD Mixonomi																														
Type of floor covering	EN ISO 10582	Heterogeneous Compact Resilient Floorcovering																														
Classification	EN ISO 10874	Domestic: 23 Commercial: 34 Industrial: 43																														
Technical characteristics																																
Total thickness	EN ISO 24346	2,5 mm																														
Wear layer thickness	EN ISO 24340	0,7 mm																														
Total weight	EN ISO 23997	3950 g/m ²																														
Wear layer binder content	EN ISO 10582	Type I																														
Dimensions	EN ISO 24342	<table border="1"> <tr> <td>Diamond</td> <td>38,486 x 66,66 cm</td> <td>20 planks per box = 2,56 m²</td> </tr> <tr> <td>Herringbone Left</td> <td>8,33 x 38,486 cm</td> <td>80 planks per box = 2,56 m²</td> </tr> <tr> <td>Herringbone Right</td> <td>8,33 x 38,486 cm</td> <td>80 planks per box = 2,56 m²</td> </tr> <tr> <td>Hexagon Large</td> <td>33,33 x 38,486 cm</td> <td>20 planks per box = 1,92 m²</td> </tr> <tr> <td>Hexagon Small</td> <td>20 x 23,094 cm</td> <td>60 planks per box = 2,04 m²</td> </tr> <tr> <td>Rectangle</td> <td>10 x 50 cm</td> <td>75 planks per box = 3,75 m²</td> </tr> <tr> <td>Square</td> <td>25 x 25 cm</td> <td>60 planks per box = 3,72 m²</td> </tr> <tr> <td>Trapeze</td> <td>16,66 x 38,486 cm</td> <td>40 planks per box = 1,92 m²</td> </tr> <tr> <td>Triangle Large</td> <td>38,486 x 38,486 cm</td> <td>40 planks per box = 2,56 m²</td> </tr> <tr> <td>Triangle Small</td> <td>19,243 x 19,243 cm</td> <td>120 planks per box = 1,92 m²</td> </tr> </table>	Diamond	38,486 x 66,66 cm	20 planks per box = 2,56 m ²	Herringbone Left	8,33 x 38,486 cm	80 planks per box = 2,56 m ²	Herringbone Right	8,33 x 38,486 cm	80 planks per box = 2,56 m ²	Hexagon Large	33,33 x 38,486 cm	20 planks per box = 1,92 m ²	Hexagon Small	20 x 23,094 cm	60 planks per box = 2,04 m ²	Rectangle	10 x 50 cm	75 planks per box = 3,75 m ²	Square	25 x 25 cm	60 planks per box = 3,72 m ²	Trapeze	16,66 x 38,486 cm	40 planks per box = 1,92 m ²	Triangle Large	38,486 x 38,486 cm	40 planks per box = 2,56 m ²	Triangle Small	19,243 x 19,243 cm	120 planks per box = 1,92 m ²
Diamond	38,486 x 66,66 cm	20 planks per box = 2,56 m ²																														
Herringbone Left	8,33 x 38,486 cm	80 planks per box = 2,56 m ²																														
Herringbone Right	8,33 x 38,486 cm	80 planks per box = 2,56 m ²																														
Hexagon Large	33,33 x 38,486 cm	20 planks per box = 1,92 m ²																														
Hexagon Small	20 x 23,094 cm	60 planks per box = 2,04 m ²																														
Rectangle	10 x 50 cm	75 planks per box = 3,75 m ²																														
Square	25 x 25 cm	60 planks per box = 3,72 m ²																														
Trapeze	16,66 x 38,486 cm	40 planks per box = 1,92 m ²																														
Triangle Large	38,486 x 38,486 cm	40 planks per box = 2,56 m ²																														
Triangle Small	19,243 x 19,243 cm	120 planks per box = 1,92 m ²																														
Surface treatment (PUR)		Yes - TopCleanXP™																														
Beveled edges		No																														
Technical performances																																
Dimensional stability	EN ISO 23999	≤ 0,10 %																														
Curl resultant to heat	EN ISO 23999	≤ 2 mm																														
Reaction to fire	EN 13501-1	B _{fl} -s1 glued over concrete substrate B _{fl} -s1 glued over wood substrate																														
Residual indentation	EN ISO 24343-1	≤ 0,05 mm																														
Furniture leg	EN 424	No damage																														
Castor chair	ISO 4918 - EN 425	No damage																														
Impact sound reduction	EN ISO 717-2	ΔL _w = 2 dB																														
Reduction of in-room impact noise	EN ISO 31-074	Class C (L _{n,ew} < 85 dB)																														
Thermal resistance	EN ISO 10456	0,02 m ² K/W																														
Light fastness	EN ISO 105-B02 (method 3a)	≥ 6																														
Chemical resistance	EN ISO 26987	Not affected (0)																														
Slip resistance	DIN 51130 EN 13893	R9 μ ≥ 0,30																														
Electrical properties	EN 1815 EN 1081	<2 kV on concrete > 10 ⁹ Ohm																														
Peeling resistance	EN ISO 24345	≥ 50N / 50mm																														
Underfloor heating		Suitable - max. 27 °C																														

The above information is subject to modification for the benefit of further improvement. (05/17).

Tarkett's instructions regarding installation, cleaning and maintenance should be observed. Please contact Tarkett at the address shown for these instructions.

CUSTOMS TARIFF : 4820 5000 00



Product details

	Diamond 38,486 x 66,66 cm	Herringbone Left 8,33 x 38,486 cm	Herringbone Right 8,33 x 38,486 cm	Hexagon Large 33,33 x 38,486 cm	Hexagon Small 20 x 23,094 cm	Rectangle 10 x 50 cm	Square 25 x 25 cm	Trapèze 16,66 x 38,486 cm	Triangle Large 38,486 x 38,486 cm	Triangle Small 19,243 x 19,243 cm
Milk	24444001	24445001	24446001	24440001	24447001	24449001	24448001	24441001	24443001	24442001
Ivory	24444002	24445002	24446002	24440002	24447002	24449002	24448002	24441002	24443002	24442002
Banana	24444003	24445003	24446003	24440003	24447003	24449003	24448003	24441003	24443003	24442003
Drage	24444004	24445004	24446004	24440004	24447004	24449004	24448004	24441004	24443004	24442004
Mint	24444005	24445005	24446005	24440005	24447005	24449005	24448005	24441005	24443005	24442005
Forget Me Not	24444006	24445006	24446006	24440006	24447006	24449006	24448006	24441006	24443006	24442006
Capuccino	24444007	24445007	24446007	24440007	24447007	24449007	24448007	24441007	24443007	24442007
Craft	24444008	24445008	24446008	24440008	24447008	24449008	24448008	24441008	24443008	24442008
Dune	24444009	24445009	24446009	24440009	24447009	24449009	24448009	24441009	24443009	24442009
Colombo	24444010	24445010	24446010	24440010	24447010	24449010	24448010	24441010	24443010	24442010
Rosewood	24444011	24445011	24446011	24440011	24447011	24449011	24448011	24441011	24443011	24442011
Poppy	24444012	24445012	24446012	24440012	24447012	24449012	24448012	24441012	24443012	24442012
Jade	24444013	24445013	24446013	24440013	24447013	24449013	24448013	24441013	24443013	24442013
Aqua	24444014	24445014	24446014	24440014	24447014	24449014	24448014	24441014	24443014	24442014
Ashes	24444015	24445015	24446015	24440015	24447015	24449015	24448015	24441015	24443015	24442015
Clay	24444016	24445016	24446016	24440016	24447016	24449016	24448016	24441016	24443016	24442016
Chestnut	24444017	24445017	24446017	24440017	24447017	24449017	24448017	24441017	24443017	24442017
Ochre	24444018	24445018	24446018	24440018	24447018	24449018	24448018	24441018	24443018	24442018
Terracotta	24444019	24445019	24446019	24440019	24447019	24449019	24448019	24441019	24443019	24442019
Strawberry	24444020	24445020	24446020	24440020	24447020	24449020	24448020	24441020	24443020	24442020
Peacock	24444021	24445021	24446021	24440021	24447021	24449021	24448021	24441021	24443021	24442021
Cobalt	24444022	24445022	24446022	24440022	24447022	24449022	24448022	24441022	24443022	24442022
Charcoal	24444023	24445023	24446023	24440023	24447023	24449023	24448023	24441023	24443023	24442023
Liquorice	24444024	24445024	24446024	24440024	24447024	24449024	24448024	24441024	24443024	24442024
Tobacco	24444025	24445025	24446025	24440025	24447025	24449025	24448025	24441025	24443025	24442025
Kahlua	24444026	24445026	24446026	24440026	24447026	24449026	24448026	24441026	24443026	24442026
Burgundy	24444027	24445027	24446027	24440027	24447027	24449027	24448027	24441027	24443027	24442027
Emerald	24444028	24445028	24446028	24440028	24447028	24449028	24448028	24441028	24443028	24442028
Kensington Green	24444029	24445029	24446029	24440029	24447029	24449029	24448029	24441029	24443029	24442029
Prussian Blue	24444030	24445030	24446030	24440030	24447030	24449030	24448030	24441030	24443030	24442030
Copper	24544031	24545031	24546031	24540031	24547031	24549031	24548031	24541031	24543031	24542031
Brass	24544032	24545032	24546032	24540032	24547032	24549032	24548032	24541032	24543032	24542032
Silver	24544033	24545033	24546033	24540033	24547033	24549033	24548033	24541033	24543033	24542033

Technical data iD Inspiration 55-70

Certification & classification	Standards	iD Inspiration 55	iD Inspiration 70
Type of floor covering	EN ISO 10582	Heterogeneous Compact Resilient Floorcovering	Heterogeneous Compact Resilient Floorcovering
Classification	EN ISO 10874	Domestic: 23 Commercial: 33 Industrial: 42	Domestic: 23 Commercial: 34 Industrial: 43
Technical characteristics			
Total thickness	EN ISO 24346	2,5 mm	2,5 mm
Wear layer thickness	EN ISO 24340	0,55 mm	0,7 mm
Total weight	EN ISO 23997	3950 g/m ²	4000 g/m ²
Wear layer binder content	EN ISO 10582	Type I	Type I
Dimensions	EN ISO 24342	Planks 16,66 x 100 cm, 22 planks/box = 3,67 m ² 12,5 x 122 cm, 24 planks/box = 3,66 m ² 20 x 122 cm, 15 planks/box = 3,66 m ² 25 x 122 cm, 12 planks/box = 3,66 m ² 25 x 150 cm, 10 planks/box = 3,75 m ² Tiles 25 x 50 cm, 30 tiles/box = 3,75 m ² 50 x 50 cm, 15 tiles/box = 3,75 m ² 50 x 100 cm, 7 tiles/box = 3,50 m ² 100 x 100 cm, 3 tiles/box = 3 m ²	
Surface treatment (PUR)		TopCleanXP™	TopCleanXP™
Beveled edges		Yes	Yes
Technical performances			
Dimensional stability	EN ISO 23999	≤ 0,10 %	≤ 0,10 %
Curl resultant to heat	EN ISO 23999	≤ 2 mm	≤ 2 mm
Reaction to fire	EN 13501-1	B _n -s1 glued on wood panel and concrete	B _n -s1 glued on wood panel and concrete
Residual indentation	EN ISO 24343-1	≤ 0,05 mm	≤ 0,05 mm
Furniture leg	EN 424	No damage	No damage
Castor chair	ISO 4918 - EN 425	No damage	No damage
Impact sound reduction	EN ISO 717-2	ΔL _w = 2 dB	ΔL _w = 2 dB
Reduction of in-room impact noise	EN ISO 31-074	Class C (L _{n,e,w} < 85 dB)	Class C (L _{n,e,w} < 85 dB)
Thermal resistance	EN ISO 10456	0,02 m ² K/W	0,02 m ² K/W
Light fastness	EN ISO 105-B02 (method 3a)	≥ 6	≥ 6
Chemical resistance	EN ISO 26987	Not affected (0)	Not affected (0)
Slip resistance	DIN 51130 EN 13893	R9 / R10 depending on embossing μ ≥ 0,30	R9 / R10 depending on embossing μ ≥ 0,30
Electrical properties	EN 1815 EN 1081	<2 kV on concrete > 10 ⁹ Ohm	<2 kV on concrete > 10 ⁹ Ohm
Peeling resistance	EN ISO 24345	≥ 50N / 50mm	≥ 50N / 50mm
Underfloor heating		Suitable - max. 27 °C	Suitable - max. 27 °C

The above information is subject to modification for the benefit of further improvement. (01/17).

Tarkett's instructions regarding installation, cleaning and maintenance should be observed. Please contact Tarkett at the address shown for these instructions.

CUSTOMS TARIFF: 4820 5000 00



Product & accessories details

DESIGN	COLOUR	LRV	SKIRTING	DESIGN	COLOUR	LRV	SKIRTING
Antik Oak	Beige	30,05%	26640601	Bardiglio	Lime Stone	33,13%	26640355
Antik Oak	Brown	17,42%	26640602	Bardiglio	Grey	38,86%	26640356
Antik Oak	Dark Grey	23,89%	26640603	Bardiglio	Dark Grey	29,76%	26640357
Antik Oak	Grey	33,95%	26640264	Bardiglio	Anthracite	16,04%	26640358
Antik Oak	Natural	22,72%	26640605	Caviar	Misty Grey	25,81%	26640326
Antik Oak	Light Grey	26,02%	26640261	Caviar	Tobacco	19,62%	26640327
Antik Oak	Anthracite	15,04%	26640262	Caviar	Grey	49,89%	26640328
Antik Oak	Middle Grey	25,50%	26640263	Caviar	Brown	13,64%	26640329
Brushed Pine	Brown	19,90%	26640613	Caviar	Mauve	30,02%	26640330
Brushed Pine	Grey	27,95%	26640614	Caviar	Beige	37,77%	26640331
Brushed Pine	Natural	24,60%	26640265	Caviar	Foggy Blue	35,24%	26640332
Brushed Pine	White	42,66%	26640266	Composite	Warm Grey	37,82%	26640316
Contemporary Oak	Grey	28,20%	26640346	Composite	Cool Grey	30,45%	26640317
Contemporary Oak	Grege	30,32%	26640347	Composite	Black	8,87%	26640318
Contemporary Oak	Natural	26,42%	26640348	Metal Frame	Rose	42,20%	26640322
Contemporary Oak	Brown	16,06%	26640349	Metal Frame	Platinum	37,04%	26640323
Elm	Light Grey	45,88%	26640350	Metal Frame	Aluminium	39,91%	26640324
Elm	Beige	45,40%	26640351	Metal Frame	Stainless	28,11%	26640325
Elm	Natural	38,47%	26640352	Oxide	Copper	10,85%	26640359
Elm	Grege	37,52%	26640353	Oxide	Steel	18,07%	26640360
Elm	Brown	21,92%	26640354	Oxide	Black Steel	10,67%	26640361
English Oak	Beige	23,69%	26640624	Polished Concrete	Light Grey	41,57%	26640319
English Oak	Brown	17,58%	26640625	Polished Concrete	Medium Grey	31%	26640320
English Oak	Light	25,10%	26640626	Polished Concrete	Dark Grey	17,32%	26640321
English Oak	Natural	24,52%	26640627	Rock	Beige	43,87%	26640269
English Oak	Light Beige	45,42%	26640267	Rock	Black	9,74%	26640270
English Oak	Grey Beige	33,74%	26640268	Rock	Brown	11,27%	26640271
Pallet Pine	White	49,16%	26640339	Rock	Grege	48,04%	26640272
Pallet Pine	Beige	38,20%	26640340	Rock	Grey	34,79%	26640273
Pallet Pine	Natural	40,21%	26640341	Rustic Slate	Black	5,59%	26640274
Pallet Pine	Brown	30,11%	26640342	Rustic Slate	Beige	29%	26640275
Patina Ash	Beige	43,21%	26640343	Rustic Slate	Grey	31,83%	26640276
Patina Ash	Brown	29,79%	26640344	Terrazzo	Grey	23,18%	26640378
Patina Ash	Grey	31,03%	26640345	Terrazzo	Green	24,02%	26640379
Rustic Oak	Stone Brown	7,5%	26640370	Terrazzo	Anthracite	9,42%	26640380
Rustic Oak	Dark Grey	14,18%	26640371	Tisse	Beige	19,25%	26640277
Rustic Oak	Medium Grey	21,68%	26640372	Tisse	Black	5,02%	26640278
Rustic Oak	Light Grey	45,58%	26640373	Tisse	Light	30,19%	26640279
Rustic Oak	Natural	35,52%	26640374	Tisse	Brown	12,11%	26640280
Rustic Oak	Beige	34,56%	26640375	Tisse	Red	12,31%	26640281
Rustic Oak	Brown	20,49%	26640376	Tisse	Blue	13,05%	26640282
Rustic Oak	Medium Brown	19,91%	26640377	Tisse	Green	20,32%	26640283
Scandinavian Oak	Light Beige	46,86%	26640333	Trend Line	Black	11,10%	26640284
Scandinavian Oak	Medium Beige	38,13%	26640334	Trend Line	Interferential	10,60%	26640285
Scandinavian Oak	Dark Beige	38,75%	26640335	Trend Line	Silver	24,61%	26640286
Scandinavian Oak	Light Grey	45,99%	26640336	Twine	Light Grey	32,60%	26640362
Scandinavian Oak	Medium Grey	39,50%	26640337	Twine	Medium Grey	25,16%	26640363
Scandinavian Oak	Dark Grey	21,63%	26640338	Twine	Dark Grey	15,91%	26640364
Trend Line	Black	11,10%	26640284	Twine	Blue Grey	24,34%	26640365
Trend Line	Interferential	10,60%	26640285	Twine	Turquoise	16,08%	26640366
Trend Line	Silver	24,61%	26640286	Twine	Denim	13,52%	26640367
Vintage Teak	Grey	17,72%	26640692	Twine	Indigo	11,86%	26640368
Vintage Teak	Natural	6,61%	26640693	Twine	Purple	17,18%	26640369
Wenge	Black	6,15%	26640290	Vintage Zinc	Black	5,24%	26640287
Wenge	Natural	6,01%	26640291	Vintage Zinc	Rust	10,10%	26640288
Wenge	Grey	17,66%	26640292	Vintage Zinc	Silver	19,36%	26640289
Wenge	Grege	23,89%	26640315				

Technical data iD Inspiration 40

Certification & classification	Standards	iD Inspiration 40
Type of floor covering	EN ISO 10582	Heterogeneous Compact Resilient Floorcovering
Classification	EN ISO 10874	Domestic: 23 Commercial: 32 Industrial: 41
Technical characteristics		
Total thickness	EN ISO 24346	2,2 mm
Wear layer thickness	EN ISO 24340	0,4 mm
Total weight	EN ISO 23997	3700 g/m ²
Wear layer binder content	EN ISO 10582	Type I
Dimensions	EN ISO 24342	16,66 x 100 cm, 25 planks/box = 4,17 m ² 20 x 122 cm, 17 planks/box = 4,15 m ² 50 x 50 cm, 17 tiles/box = 4,25 m ² 50 x 100 cm, 8 tiles/box = 4,00 m ²
Surface treatment (PUR)		TopCleanXP™
Beveled edges		No
Technical performances		
Dimensional stability	EN ISO 23999	≤ 0,10 %
Curl resultant to heat	EN ISO 23999	≤ 2 mm
Reaction to fire	EN 13501-1	B _f -s1 glued over concrete substrate B _f -s1 glued over wood substrate
Residual indentation	EN ISO 24343-1	≤ 0,05 mm
Furniture leg	EN 424	No damage
Castor chair	ISO 4918 - EN 425	No damage
Impact sound reduction	EN ISO 717-2	ΔL _w = 3 dB
Reduction of in-room impact noise	EN ISO 31-074	Class C (L _{n,e,w} < 85 dB)
Thermal resistance	EN ISO 10456	0,02 m ² K/W
Light fastness	EN ISO 105-B02 (method 3a)	≥ 6
Chemical resistance	EN ISO 26987	Not affected (0)
Slip resistance	DIN 51130 EN 13893	R9 / R10 depending on embossing μ ≥ 0,30
Electrical properties	EN 1815 EN 1081	<2 kV on concrete > 10 ⁹ Ohm
Peeling resistance	EN ISO 24345	≥ 50N / 50mm
Underfloor heating		Suitable - max. 27 °C

The above information is subject to modification for the benefit of further improvement. (01/17).
Tarkett's instructions regarding installation, cleaning and maintenance should be observed. Please contact Tarkett at the address shown for these instructions.

CUSTOMS TARIFF: 4820 5000 00

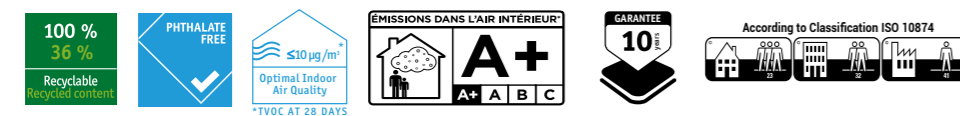

Product & accessories details

DESIGN	COLOUR	EMBOSSING	SLIP RESISTANCE DIN 51130	20 x 122 cm	16,6 x 100 cm	50 x 50 cm	50 x 100 cm	LRV	SKIRTING
Antik Oak	Light Brown	Rustic	R10	24260132				29,30%	26640 381
	White	Rustic	R10	24260133				36,56%	26640 382
	Grege	Rustic	R10	24260134				38,05%	26640 383
	Classical	Rustic	R10	24260135				33,43%	26640 384
	Dark Brown	Rustic	R10	24260136				12,48%	26640 385
Brushed Pine	White	Rustic	R10	24260016				42,66%	26640 266
	Natural Grey	Rustic	R10	24260137				29,59%	26640 387
English Oak	Light Brown	Rustic	R10	24260138				28,41%	26640 388
	Grege	Natural	R10	24260139				32,87%	26640 389
	Dark Brown	Natural	R10	24260140				9,16%	26640 390
Large Beech	Classical	Natural	R10	24260141				30,06%	26640 391
	Natural	Soft Wood	R10		24261142			31,08%	26640 392
Maple	Studio	Soft wood	R10		24261143			44,82%	26640 393
	White	Natural	R10	24260144				21,04%	26640 394
Modern Oak	Beige	Natural	R10	24260145				43,49%	26640 395
	Classical	Natural	R10	24260146				33,86%	26640 396
Rock	Grey	Stone	R10			24262066		34,79%	26640 273
	Natural Grey	Stone	R10			24262147		39,13%	26640 398
Soft Walnut	Red Brown	Soft wood	R10	24260147				8,25%	26640 399
	Classical	Soft wood	R10	24260149				17,24%	26640 400
Vintage Zinc	Alu	Flat	R9				24263150	17,67%	26640 401
	Light	Natural	R10	24260151				53,50%	26640 402
White Oak	Grey	Natural	R10	24260152				34,89%	26640 403
	Black	Natural	R10	24260153				8,44%	26640 404
Polished Concrete	Light Grey	Beton	R10			24262075		41,57%	26640 319
	Medium Grey	Beton	R10			24262076		31%	26640 320
	Dark Grey	Beton	R10			24262077		17,32%	26640 321
Patina Ash	Beige	Weathered	R10	24260106				43,21%	26640 343
	Brown	Weathered	R10	24260107				29,79%	26640 344
	Grey	Weathered	R10	24260108				31,03%	26640 345
Rustic Oak	Medium Grey	Natural	R10	24260123				21,68%	26640 372
	Light Grey	Natural	R10	24260124				45,58%	26640 373
	Natural	Natural	R10	24260125				35,52%	26640 374
	Brown	Natural	R10	24260127				20,49%	26640 376

Technical data iD Essential 30

Certification & classification	Standards	iD Essential 30
Type of floor covering	EN ISO 10582	Compact Resilient Floorcovering
CE certification	EN 14041	Yes
Classification	EN ISO 10874 (EN 685)	Domestic: 23 Commercial: 31
Technical characteristics		
Total thickness	EN ISO 24346 (EN 428)	2,0 mm
Wear layer thickness	EN ISO 24340	0,3 mm
Total weight	EN ISO 23997	3400 g/m ²
Wear layer binder content	EN ISO 10582	Type I
Dimensions	EN ISO 24342 (EN 427)	
	Planks	15,2 x 91,4 cm - 24 planks /box = 3,34 m ² art. no. 3976 ___ 3 digit colour number
		22,9 x 121,9 cm art. no. 3977 / 24707 ___ 3 digit colour number
	Tiles	30,5 x 61,0 cm - 18 tiles/box = 3.34 m ² art. no. 3979 ___ 3 digit colour number
Surface treatment (PUR)		TopCleanXP™
Beveled edges		No
Technical performances		
Dimensional stability	EN ISO 23999 (EN 434)	≤ 0,25 %
Curl resultant to heat	EN ISO 23999 (EN 434)	≤ 2 mm
Reaction to fire	EN 13501-1	B _{fl} -s1 glued over A2fl or A1fl substrate (concrete)
Residual indentation	EN ISO 24343-1 (EN 433)	Required value: ≤ 0,10 mm Average measured value: 0,03 mm
Furniture leg	EN 424	No damage
Castor chair	ISO 4918 - EN 425	No damage
Impact sound reduction	EN ISO 717-2	ΔL _w = 4 dB
Thermal resistance	EN ISO 10456	0,07 m ² K/W
Light fastness	EN ISO 105-B02	≥ 6
Slip resistance	DIN 51130 EN 13893	R9
Electrical properties	EN 1815 EN 1081	< 2 kV on concrete R _t > 10 ¹⁰ Ω
Resistance to chemicals	EN ISO 26987 (EN 423)	Good resistance
Underfloor heating		Suitable - max. 27 °C

The above information is subject to modification for the benefit of further improvement. (01/17).

Tarkett's instructions regarding installation, cleaning and maintenance should be observed. Please contact Tarkett at the address shown for these instructions.

CUSTOMS TARIFF: 4820 5000 00



Product & accessories details

DESIGN	COLOUR	22,9 x 121,9 cm	15,2 x 91,4 cm	30,5 x 61 cm	LRV	SKIRTING
Aspen Oak	Grey	3977 013			22,60%	
	Beige	3977 014			43,70%	
	Natural	3977 016			20,80%	
Beech	Natural		3976 020		29,80%	26640714
	Beige	24707 009			44,20%	26640 707
Cerused Oak	Light Brown	24707 010			29,80%	26641 709
	Brown	24707 011			24,40%	26642 708
Country Oak	Brown	24707 000			11,40%	
	Beige	24707 001			23,60%	26640 738
	Natural	24707 002			13,30%	26640 737
Maple	Grey	24707 003			22,10%	26640 736
	Natural		3976 031		43,10%	
Original Slate	Black			3979 006	4,20%	
	Grey			3979 007	35,00%	
Primary Pine	Dark Brown	3977 017			11,90%	
	Grege	3977 018			30,10%	
	Dark Grey	3977 019			20,30%	
	Natural	3977 020			21,90%	
Sandstone	White	3978 021			57,60%	
	Black			3979 004	6,60%	
	Brown			3979 005	15,60%	
Scratched Metal	Grey			3979 008	20,60%	26640728
	Black	3977 000			4,30%	
Smoked Oak	Brown	3977 001			10,10%	26640 712
	Natural	3977 002			18%	
	Dark Grey	3977 003			15%	26640 711
	Light Grey	3977 004			30,80%	26640 710
	White	3977 005			49,90%	
Soft Oak	Brown	3977 007			14,60%	
	Natural	3977 008	3976 008		22,30%	26640 715
	Beige	3977 009	3976 009		31,40%	26640 717
	Light Grey	3977 010	3976 010		23,70%	26640 719
	White	3977 011			53%	
Venezia	Light Brown	3977 012	3976 012		30,50%	26640 718
	Light Beige	3977 015			40,60%	26640 716
	Grey			3979 001	21,30%	26640 724
Walnut	Beige			3979 002	41,90%	
	Light Brown		3976 034		19%	
Washed Pine	White	24707 004			40,20%	26640 706
	Beige	24707 005			44,40%	26640 704
	Light Brown	24707 006			32,80%	26640 705
	Snow	24707 007			57,20%	26640 702
	Blue	24707 008			26,70%	26640 703

Technical data iD Click Ultimate

Certification & classification	Standards	iD Click Ultimate		
Type of floor covering	EN ISO 10582	Heterogeneous Compact Resilient Floorcovering		
Classification	EN ISO 10874	Domestic: 23 Commercial: 34 Industrial: 43		
Technical characteristics				
Total thickness	EN ISO 24346	6,5 mm		
Wear layer thickness	EN ISO 24340	0,7 mm		
Total weight	EN ISO 23997	11,3 kg/m ²		
Wear layer binder content	EN ISO 10582	Type I		
Dimensions	EN ISO 24342	Planks	176 x 1213 mm	6 planks/box = 1,28 m ²
		Tiles	300 x 600 mm	7 tiles/box = 1,26 m ²
Surface treatment (PUR)		Yes - PUR Ultimate		
Beveled edges		Yes - 4 Bevels		
Technical performances				
Dimensional stability	EN ISO 23999	Average measured value 0,05% Required value ≤ 0,15%		
Curl resultant to heat	EN ISO 23999	≤ 1 mm		
Reaction to fire	EN 13501-1	B _{fl} -s1		
Residual indentation	EN ISO 24343-1	≤ 0,02 mm		
Furniture leg	EN 424	No damage		
Castor chair	ISO 4918 - EN 425	No damage		
Impact sound reduction	EN ISO 717-2	ΔL _w 19 dB		
Reduction of in-room impact noise	EN ISO 31-074	Class C (L _{n,e,w} < 85 dB)		
Thermal resistance	EN ISO 10456	0,05 m ² K/W		
Light fastness	EN ISO 105-B02 (method 3a)	≥ 6		
Chemical resistance	EN ISO 26987	Very Good		
Slip resistance	DIN 51130	R9 /R10 depending on embossing		
	EN 13893	μ ≥ 0,30		
Electrical properties	EN 1815	≤ 2 kV		
Peeling resistance	EN ISO 24345	≥ 50N / 50mm		
Underfloor heating		Suitable - max. 27 °C		

The above information is subject to modification for the benefit of further improvement. (01/18).

Tarkett's instructions regarding installation, cleaning and maintenance should be observed. Please contact Tarkett at the address shown for these instructions.

CUSTOMS TARIFF : 4820 5000 00

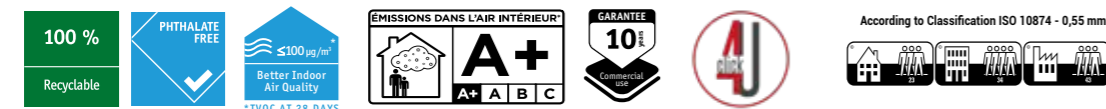

Produced under license from I4F
<https://i4f-patents.com>

Product & accessories details

DESIGN	COLOUR	17,6 x 121,3 cm	30 x 60 cm	LRV	SKIRTING
Stylish Oak	Natural	24775000		41,17	26643000
	Grey	24775001		34,1	26643001
	Beige	24775002		42,24	26643002
	White	24775003		48,98	26643003
Light Oak	Brown	24775012		26,35	26643012
	Light Grey	24775013		35,2	26643013
	Warm Brown	24775014		18,22	26643014
Riviera Oak	Grey	24775015		21,34	26643015
	Warm Brown	24775016		15,62	26643016
	Light Brown	24775017		23,61	26643017
Soft Ash	White	24777018		50,78	26643018
	Natural	24777019		39,21	26643019
Timeless Concrete	Antracite		24776021	11,33	26643021
	Grey		24776022	25,2	26643022
	Light Grey		24776020	32,86	26643020

Technical data iD Inspiration Click

Certification & classification	Standards	iD Inspiration Click
Type of floor covering	EN ISO 10582	Heterogeneous Compact Resilient Floorcovering
Classification	EN ISO 10874	Domestic: 23 Commercial: 33 Industrial: 42
Technical characteristics		
Total thickness	EN ISO 24346	4,5 mm
Wear layer thickness	EN ISO 24340	0,55
Total weight	EN ISO 23997	8000 g/m ²
Wear layer binder content	EN ISO 10582	Type I
Dimensions	EN ISO 24342	
	Planks	19,05 x 121,10 cm, 7 planks/box = 1,61 m ² 24,05 x 149,10 cm, 5 planks/box = 1,79 m ²
	Tiles	32,38 x 60,10 cm, 9 tiles/box = 1,75 m ²
Surface treatment (PUR)		Yes - TopCleanXP™
Beveled edges		Yes
Technical performances		
Dimensional stability	EN ISO 23999	≤ 0,10 %
Reaction to fire	EN 13501-1	B _f -s1 loose laid over concrete substrate
Residual indentation	EN ISO 24343-1	≤ 0,10 mm
Furniture leg	EN 424	No damage
Castor chair	ISO 4918 - EN 425	No damage
Curl resultant to heat	EN ISO 23999	≤ 2 mm
Reduction of in-room impact noise	EN ISO 31-074	Class C (L _{n,ew} < 85 dB)
Impact sound reduction	EN ISO 717-2	ΔL _w = 3 dB
Thermal resistance	ISO 10456	0,04 m ² K/W
Light fastness	EN ISO 105-B02	≥ 6
Slip resistance	DIN 51130 EN 13893	R9 / R10 depending on embossing μ ≥ 0,30
Chemical resistance	EN ISO 26987	Not affected (0)
Electrical properties	EN 1815 EN 1081	< 2 kV on concrete ≥ 10 ⁹ Ohm
Peeling resistance	EN ISO 24345	≥ 50N / 50mm
Underfloor heating		Suitable - max. 27 °C

The above information is subject to modification for the benefit of further improvement. (01/17).

Tarkett's instructions regarding installation, cleaning and maintenance should be observed. Please contact Tarkett at the address shown for these instructions. CUSTOMS TARIFF: 4820 5000 00



Product & accessories details

DESIGN	COLOUR	19,05 x 121,10 cm	24,05 x 149,10 cm	32,38 x 60,10 cm	LRV	SKIRTING	SLIP RESISTANCE DIN 51130
Contemporary Oak	Grey		24265109		28,20%	26640 346	R9
	Grege		24265110		30,32%	26640 347	R9
	Natural		24265111		26,42%	26640 348	R9
	Brown		24265112		16,06%	26640 349	R9
Elm	Light Grey		24265113		45,88%	26640 350	R9
	Beige		24265114		45,40%	26640 351	R9
	Natural		24265115		38,47%	26640 352	R9
Oxide	Copper			24266118	10,85%	26640 359	R9
	Steel			24266119	18,07%	26640 360	R9
	Black Steel			24266120	10,67%	26640 361	R9
Patina Ash	Beige	24264106			43,21%	26640 343	R9
	Brown	24264107			29,79%	26640 344	R9
	Grey	24264108			31,03%	26640 345	R9
Rustic Oak	Stone Brown	24264121			7,25%	26640 370	R9
	Dark Grey	24264122			14,18%	26640 371	R9
	Medium Grey	24264123			21,68%	26640 372	R9
	Light Grey	24264124			45,58%	26640 373	R9
Terrazzo	Grey			24266129	23,18%	26640 378	R9
	Green			24266130	24,02%	26640 379	R9
	Anthracite			24266131	9,42%	26640 380	R9

Technical data iD Inspiration Click^{PLUS}

Certification & classification	Standards	iD Inspiration Click ^{PLUS}
Type of floor covering	EN ISO 10582	Heterogeneous Compact Resilient Floorcovering
CE certification	EN 14041	Yes
Classification	EN ISO 10874	Domestic: 23 Commercial: 33 Industrial: 42
Technical characteristics		
Total thickness	EN ISO 24346	4,5 mm
Wear layer thickness	EN ISO 24340	0,55
Surface treatment (PUR)		Yes - TopCleanXP™
Total weight	EN ISO 23997	8000 g/m ²
Beveled edges		Yes
Wear layer binder content	EN ISO 10582	Type I
Dimensions	EN ISO 24342	
	Planks	19,05 x 121,10 cm - 7 planks/box = 1,66 m ² 24,05 x 149,10 cm - 5 planks/box = 1,79 m ²
	Tiles	49,05 x 99,10 cm - 3 tiles/box = 1,46 m ²
Technical performances		
Dimensional stability	EN ISO 23999	≤ 0,10 %
Curl resultant to heat	EN ISO 23999	≤ 2 mm
Reaction to fire	EN 13501-1	B _n -s1
Residual indentation	EN ISO 24343-1	≤ 0 10 mm
Furniture leg	EN 424	No damage
Castor chair	ISO 4918 - EN 425	No damage
Impact sound reduction	EN ISO 717-2	ΔL _w = 3 dB
Reduction of in-room impact noise	EN ISO 31-074	Class C (L _{n,e,w} < 85 dB)
Thermal resistance	EN ISO 10456	0 04 m ² K/W
Light fastness	EN ISO 105-B02 (method 3a)	≥ 6
Chemical resistance	EN ISO 26987	Very good
Slip resistance	DIN 51130 EN 13893	R9 / R10 depending on embossing μ ≥ 0 30
Electrical properties	EN 1815 EN 1081	< 2 kV on concrete ≥ 10 ⁹ Ohm
Underfloor heating		Suitable - max. 27 °C
Adhesion wear layer	EN ISO 24345	≥ 50N / 50mm
Colours		22

The above information is subject to modification for the benefit of further improvement. (10/17).

Tarkett's instructions regarding installation, cleaning and maintenance should be observed. Please contact Tarkett at the address shown for these instructions.

CUSTOMS TARIFF : 4820 5000 00

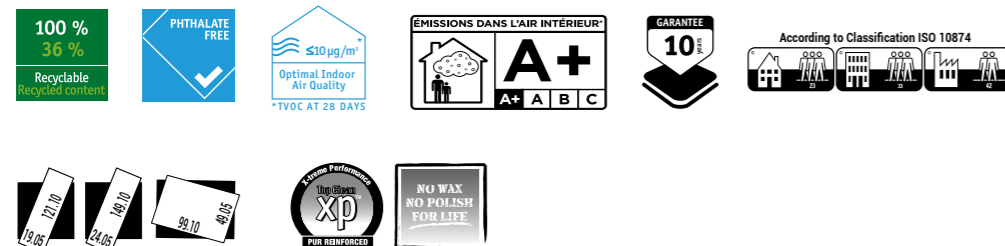

Product & accessories details

DESIGN	COLOUR	19,05 x 121,10 cm	24,05 x 149,10 cm	49,05 x 99,10 cm	LRV	SKIRTING	SLIP RESISTANCE DIN 51130
Lime Oak	Grege	24360053			27,00%	26640766	R10
	Dark Grey	24360054			18,97%	26640767	R10
	Light Beige	24360049			48,42%	26640762	R10
	Black	24360056			8,25%	26640769	R10
	White	24360048			50,74%	26640761	R10
	Brown	24360055			14,61%	26640768	R10
	Grey	24360052			31,90%	26640765	R10
	Natural	24360051			35,85%	26640764	R10
	Beige	24360050			42,51%	26640763	R10
	Alpine Oak	Grey		24361059		22,39%	26640772
Natural			24361057		28,32%	26640770	R10
Brown			24361058		10,13%	26640771	R10
White			24361061		45,76%	26640774	R10
Legacy Pine	Black		24361060		7,71%	26640773	R10
	Brown	24360157			11,97%	26640778	R10
	Dark Grey	24360156			12,24%	26640777	R10
	Medium Grey	24360155			33,02%	26640776	R10
Rough Concrete	Light Grey	24360154			44,31%	26640775	R10
	Grey			24363158	34,27%	26640780	R9
	Black			24363160	7,77%	26640782	R9
	White			24363157	43,67%	26640779	R9
	Dark Grey			24363159	22,19%	26640781	R9

Technical data iD Essential Click

Certification & classification	Standards	iD Essential Click
Type of floor covering	EN ISO 10582	Compact Resilient Floorcovering
CE certification	EN 14041	Yes
Classification	EN ISO 10874 (EN 685)	Residential: 23 Commercial: 31
Technical characteristics		
Total thickness	EN ISO 24346	4,0 mm
Wear layer thickness	EN ISO 24340	0,30 mm
Total weight	EN ISO 23997	7400 g/m ²
Wear layer binder content	EN ISO 10582	Type I
Dimensions	EN ISO 24342	
	Planks	18,3 x 122 cm 9 planks/box (= 2,009 m ²)
	Tiles	31 x 60,3 cm 9 tiles/box (= 1,682 m ²)
Surface treatment (PUR)		Yes - TopClean™
Beveled edges		Yes - micro bevel
Technical performances		
Dimensional stability	EN ISO 23999	≤ 0,10 %
Reaction to fire	EN 13501-1	B _{fl} -s1 over concrete and wood substrate
Residual indentation	EN ISO 24343-1	≤ 0,08 mm
Furniture leg	EN 424	No damage
Castor chair	ISO 4918	No damage
Reduction of in room impact noise	NF S31-074	78 dB (Class C - L _{n,e,w} < 85 dB)
Impact sound reduction	EN ISO 717-2	ΔL _w = 5 dB 13 dB with Tarkomfort Pro
Thermal resistance	ISO 10456	0,03 m ² K/W
Light fastness	EN ISO 105-B02	≥ 6
Slip resistance	EN 13893 DIN 51130	μ ≥ 0.30 DS R9 (tiles) R10 (planks)
Electrical properties	EN 1815 EN 1081	ca. 10 ⁹ Ω
Resistance to chemicals	EN ISO 26987	High resistance
Underfloor heating		Suitable - max. 27 °C

The above information is subject to modification for the benefit of further improvement. (01/17).

Tarkett's instructions regarding installation, cleaning and maintenance should be observed. Please contact Tarkett at the address shown for these instructions.

CUSTOMS TARIFF: 4820 5000 00

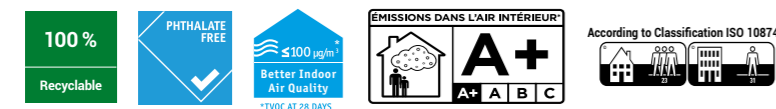

Product & accessories details

DESIGN	COLOUR	18,3 x 122 cm	31 x 60,3 cm	LRV	SKIRTING
Delicate Oak	Natural	24722002		17,3%	26640 715
	Beige	24722000		47,5	26640 707
Limewashed Oak	Brown	24722001		20,7%	26640 708
	Brown		24723001	7,4%	26640 726
Rust Metal	Black		24723002	4,8%	26640 727
	Grey		24723000	27,2%	26640 724
Toasted Oak	Light Grey	24722003		26,7%	26640 710
	Dark Grey	24722004		16,5%	26640 711

Technical data iD Inspiration Loose-Lay

Certification & classification	Standards	iD Inspiration Loose-Lay
Type of floor covering	EN ISO 10582	Compact resilient floor covering
CE certification	EN 14041	Yes
Classification	EN ISO 10874 (EN 685)	Commercial: 33 Industrial: 42
Technical characteristics		
Total thickness	EN ISO 24346	4,5 mm
Wear layer thickness	EN ISO 24340	0,55 mm
Total weight	EN ISO 23997	7500 g/m ²
Wear layer binder content	EN ISO 10582	Type I
Dimensions	EN ISO 24342 (EN 427)	22,9 x 121,9 cm Planks 10 planks/box (= 2,79 m ² - 20,9 kg) 52 boxes/pallet (= 145,08 m ² - 1088,1 kg) 30,5 x 61 cm Tiles 14 tiles/box (= 2,6 m ² - 19,5 kg) 54 boxes/pallet (= 140,4 m ² - 1053 kg)
Surface treatment (PUR)		Yes
Beveled edges		No
Technical performances		
Dimensional stability	EN ISO 23999	≤ 0,10 %
Reaction to fire	EN 13501-1	B _{fl} -s1
Residual indentation	EN ISO 24343-1	≤ 0,10 mm
Furniture leg	EN 424	No damage
Castor chair	ISO 4918 - EN 425	No damage
Impact sound reduction	EN ISO 717-2	8 dB
Thermal resistance	ISO 10456	0,04 m ² K/W
Light fastness	EN ISO 105-B02	≥ 6
Slip resistance	DIN 51130 EN 13893	μ ≥ 0,30 DS R9
Electrical properties	EN 1815 EN 1081	ca. 10 ¹¹ Ω
Resistance to chemicals	EN ISO 26987	High resistance

The above information is subject to modification for the benefit of further improvement. (01/17).

Tarkett's instructions regarding installation, cleaning and maintenance should be observed. Please contact Tarkett at the address shown for these instructions.

CUSTOMS TARIFF: 4820 5000 00

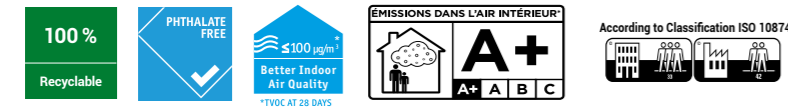

Product & accessories details

DESIGN	COLOUR	22,9 x 121,9 cm	30,5 x 61 cm	LRV	SKIRTING
Beach Wood	Beige	24640009		35,6%	26640 753
	Grey	24640010		35,7%	26640 754
Béton	White		24641000	63,1%	26640 740
	Black		24641001	4,9%	26640 741
	Grey		24641002	17,5%	26640 739
Christmas Pine	White	24640006		53,1%	26640 746
	Natural	24640007		20,7%	26640 745
Delicate Wood	Brown	24640008		15,7%	26640 744
	White	24640011		50,4%	26640 758
Elegant Oak	Grege	24640012		23,3%	26640 760
	Black	24640013		7,0%	26640 759
Limed Oak	Beige	24640014		31,5%	26640 743
	Natural	24640015		24,3%	26640 742
Mountain Oak	Beige	24640000		48,9%	26640 750
	Grey	24640001		24,3%	26640 751
	Brown	24640002		6,5%	26640 752
Sawn Oak	Natural	24640003		21,6%	26640 749
	Brown	24640004		15,6%	26640 748
Sawn Oak	Black	24640005		5,3%	26640 747
	Grey	24640016		18,0%	26640 755
	Brown	24640017		17,1%	26640 756
	Dark Brown	24640018		9,9%	26640 757

Technical data iD Square

Certification & classification	Standards	iD Square
Type of floor covering	EN ISO 10582	Acoustic resilient floor covering
CE certification	EN 14041	Yes
Classification	EN ISO 10874 (EN 685)	Commercial very heavy: 34
Technical characteristics		
Total thickness	EN ISO 24346	4,5 mm
Wear layer thickness	EN ISO 24340	0,80 mm
Total weight	EN ISO 23997	5195 g/m ²
Wear layer binder content	EN ISO 10582	Type I
Dimensions	EN ISO 24342 (EN 427)	
	Planks	25 x 100 cm 9 planks/box (= 2,25 m ² - 12 kg) - 48 boxes/pallet
	Tiles	50 x 50 cm 9 tiles/box (= 2,25 m ² - 12 kg) - 48 boxes/pallet 66 x 66 cm 5 tiles/box (= 2,22 m ² - 12 kg) - 26 boxes/pallet
Technical performances		
Dimensional stability	EN ISO 23999	≤ 0,10 %
Reaction to fire	EN 13501-1	B _{fl} s1 loose-laid or glued over any A _{2fl} or A _{1fl} substrate (concrete) C _{fl} s1 loose-laid or glued over any derivate wood substrate
Residual indentation	Average measured value EN ISO 24343-1 requirement	0,15 mm ≤ 0,20 mm
Furniture leg	EN 424	No damage
Castor chair	ISO 4918 - EN 425	No damage
Reduction of in room impact noise	NF S 31-074	Class B - L _{n,ew} = < 75 dB
Impact sound reduction	EN ISO 717-2	ΔL _w = 15 dB (±1 dB)
Thermal resistance	ISO 10456	0,04 m ² K/W
Acoustical absorption	EN ISO 11654	α _w = 0,05
Light fastness	EN ISO 105-B02	≥ 6
Slip resistance	EN 13893 DIN 51130	μ ≥ 0,30 R9
Electrical properties	EN 1081	R _i > 10 ¹⁰ Ohm
Resistance to chemicals	EN ISO 26987	High resistance

The above information is subject to modification for the benefit of further improvement. (01/17).

Tarkett's instructions regarding installation, cleaning and maintenance should be observed. Please contact Tarkett at the address shown for these instructions.

CUSTOMS TARIFF : 4820 5000 00



Product & accessories details

DESIGN	COLOUR	25 x 100 cm	50 x 50 cm	66 x 66 cm	LRV
Dashes	Blue		24562100		11,06%
	Grey		24562101		17,39%
	Light Grey		24562102		30,4%
	Purple		24562103		16,38%
	Green		24562104		14,95%
Fabrics	Grege		24562000		10,21%
	Light Grey		24562001		33,47%
Grid	Grey		24562002		26,64%
	Metalic			24566000	30,77%
	Metalic Blue			24566001	24,47%
	Black			24566002	8,3%
Minimal Wood	Grey			24566003	20,36%
	Natural	24567100	24563100		19,1%
	Grey	24567101	24563101		21,97%
Patchwood	Dark Grey	24567102	24563102		18,26%
	White		24563200		35,95%
Patchwork	Grey		24563201		22,16%
	Light Grey		24560026		30,67%
Patine	Anthracite		24560024		13,54%
	Chocolat		24564042		12,24%
	Gris		24564002		24,65%
	Anthracite		24564044		16,1%
	Light Chocolate		24564040		28,89%
	Blue		24564045		13,94%
Plateau Ash	Dark Anthracite		24564046		9,79%
	Red		24564048		28,98%
	Grey	24567009	24563009		22,71%
Tisse	Dark Grey		24560032		14,57%
	Chocolat		24560033		18,65%
Vintage Zinc	Ligth Grey		24560035		35,46%
	Dark Grey			24565000	18,78%
	Beige			24565001	24,66%
	Metalic			24565002	27,78%
	Grege			24565003	10,28%
Zen	Ligth Copper			24565004	19,73%
	Brown		24560014		20,9%
	Grey		24560022		15,17%

Technical data iD Tilt

Certification & classification	Standards	iD Tilt
Type of floor covering	EN ISO 10582	Modular heterogeneous product with interlocking connection
CE certification	EN 14041	Yes
Classification	EN ISO 10874 (EN 685)	Commercial: 34 Industrial: 43
Technical characteristics		
Total thickness	EN ISO 24346	5,0 mm
Wear layer thickness	EN ISO 24340	0,70 mm
Total weight	EN ISO 23997	7400 g/m ²
Wear layer binder content	EN ISO 10582	Type I
Dimensions	EN ISO 24342 - EN 427 Tiles	91,44 x 91,44 cm (Granite) 3 tiles/box (= 2,51 m ² - 20,10 kg) 45,72 x 45,72 cm (Concrete) 10 tiles/box (= 2,09 m ² - 16,70 kg)
Surface treatment (PUR)		Yes
Technical performances		
Dimensional stability	EN ISO 23999 - EN 434	< 0,15 %
Reaction to fire	EN 13501-1	B _{fl} -s1 over concrete substrate
Residual indentation	EN ISO 24343-1 - EN 433	< 0.10 mm
Furniture leg	ISO 16581 - EN 424	No damage
Castor chair	ISO 4918 - EN 425	No damage
Curl resultant to heat	ISO 23999 - EN 434	≤ 2 mm
Impact sound reduction	EN ISO 717-2	ΔL _w = 6 dB
Thermal resistance	EN ISO 10456	approx. 0,05 m ² K/W
Light fastness	EN ISO 105-B02	≥ 6
Slip resistance	EN 13893 DIN 51130	μ ≥ 0,30 DS R9
Electrical properties	EN 1815 EN 1081	< 2 kV on concrete R1 > 10 ⁹ Ω
Resistance to chemicals	EN ISO 26987	Resistance

The above information is subject to modification for the benefit of further improvement. (01/17).

Tarkett's instructions regarding installation, cleaning and maintenance should be observed. Please contact Tarkett at the address shown for these instructions.

CUSTOMS TARIFF: 4820 5000 00

Product & accessories details

DESIGN	COLOUR	91,44 x 91,44 cm	45,72 x 45,72 cm	SKIRTING	
				WHITE	ALUMINIUM
Granite	Black	4697 004		26640 700	26640 701
	Grey	4697 005		26640 700	26640 701
	Red	4697 006		26640 700	26640 701
	Blue	4697 007		26640 700	26640 701
Concrete	Beige		24750 000	26640 700	26640 701
	Grey		24750 001	26640 700	26640 701
	Dark Grey		24750 002	26640 700	26640 701





■ WESTERN EUROPE: Austria: Tarkett Holding GmbH, Niederlassung Wien – Tel. +43 1 47 88 062 ■ Belgium: Tarkett Belux Sprl – Tel. +32 16 35 98 80 ■ Denmark: Tarkett A/S – Tel. +45 43 90 60 11 ■ Finland: Tarkett Oy – Tel. +358 9 4257 9000 ■ France: Tarkett SAS – Tel. +33 1 41 20 42 49 ■ Germany: Tarkett Holding GmbH, Bereich Objekt – Tel. +49 62 33 810 ■ Greece: Tarkett Monoprosopi Ltd – Tel. +30 210 6745 340 ■ Italy: Tarkett S.p.A. – Tel. +39 0744 7551 ■ Luxembourg: Tarkett GDL SA – Tel. +352 949 211 8804 ■ Netherlands: Tarkett Holding GmbH, Vestiging Nederland – Tel. +31 416 685 491 ■ Norway: Tarkett AS – Tel. +47 32 20 92 00 ■ Portugal: Tarkett SA – Tel. +351 21 427 64 20 ■ Spain: Tarkett Floors S.L. – Tel. +34 91 358 00 35 ■ Sweden: Tarkett Sverige AB – Tel. +46 771 25 19 00 ■ Switzerland: Tarkett Holding GmbH, Bereich Objekt Schweiz – Tel. +41 043 233 79 24 ■ Turkey: Tarkett Aspen – Tel. +90 212 213 65 80 ■ United Kingdom: Tarkett Ltd – Tel. +44 (0) 1622 854 040 ■ EASTERN EUROPE: Baltic Countries: Tarkett Baltics – Tel. +370 37 262 220 ■ Czech Republic: Tarkett org. složka – Tel. +420 271 001 600 ■ Hungary: Tarkett Polska SP Z.O.O. magyarországi fióktelepe – Tel. +36 1 437 8150 ■ Poland: Tarkett Polska Sp. z o.o. – Tel. +48 22 16 09 231 ■ Russian Federation: ZAO Tarkett RUS – Tel. +7 495 775 3737 ■ Slovakia: Tarkett Polska, organizačná zložka – Tel. +421 2 48291 317 ■ South East Europe: Tarkett SEE – Tel. +381 21 7557 649 (44) 569 12 21 ■ Ukraine: Tarkett UA – Tel. +38 (0) 44 569 12 21 ■ ASIA AND OCEANIA: Australia: Tarkett Australia Pty Ltd – Tel. +61 2 88 53 12 00 ■ China: Tarkett Floor Covering (Shanghai) Co. Ltd. – Tel. +86 (21) 60 95 68 38 ext 841 ■ North East Asia: Tarkett Hong Kong Limited – Tel. +852 2511 8716 ■ India: Tarkett France (India Branch) – Tel. +91 11 4352 4073 ■ South East Asia: Tarkett Flooring Singapore Pte. Ltd. – Tel. +65 6346 1585 ■ AFRICA: Tarkett International: Tel. +33 1 41 20 41 01 ■ MIDDLE EAST: Tarkett Middle East: Tel. +961 1 51 3363/4 ■ Israel: Tarkett International: Tel. +33 1 41 20 41 01 ■ NORTH AMERICA: USA: Tarkett Inc. – Tel. +1 713 869 5811 / Johnstone – Tel. +1 440 543 8916 ■ Canada: Tarkett Inc. – Tel. +1 450 293 173 ■ LATIN AMERICA: Brazil: Tarkett – Tel. 55 12 3954 7108 ■ Argentina - Chile - Uruguay: Tarkett Latam Mercosur - Tel. +54 11 47 08 07 72 / +54 9 11 44 46 88 82 ■ Bolivia - Colombia - Ecuador - Panama - Paraguay - Peru - Trinidad and Tobago - Venezuela: Tarkett – Tel. +55 11 9 9410 9310 / +55 11 95494 0069 ■ Mexico / Central America: Tarkett Latam Mexico - Tel. +55 11 98410 9310

08-2018

The designs and photos used in this brochure are for illustration purposes only. They are not contractual images and do not stand for product recommendation. Design: AgenceGecko / Photos: Getty images

www.professionals.tarkett.com

