

Accessories

- 474 ACCESSORIES FOR RESILIENT FLOORINGS
- 500 FLOORCRAFT
- 504 ACCESSORIES FOR HARD FLOORINGS
- 508 TARKOPROOF SEALING SOLUTION WATER TIGHTNESS LIQUID SEALANT SOLUTION FOR CLICK MODULAR PRODUCTS
- 510 ACCESSORIES FOR SPORTS FLOORINGS
- 516 ACCESSORIES FOR ALL TYPES OF FLOORINGS



ACCESSORIES FOR RESILIENT FLOORINGS



PVC WELDING RODS

COLD

Creation of a watertight joint which is necessary to prevent any penetration of water after the vinyl floorcovering has been laid.

Name of the product	Reference	Description	Logistic information
Cold welding - Commercial use	Type A	Specially designed for PVC floorcoverings that have been overlapped and double cut.	Art code: 1490 002 1 box of 24 tubes A tube for a 20 lm welding
Cold welding - Commercial use	Type C	Specially designed for PVC floorcoverings with joint opening from 0.3 mm to 4 mm.	Art code: 1490 003 1 box of 24 tubes A tube for a 10 to 15 lm welding

HOT

Name of the product	Reference	Description	Logistic information
Welding rods	Unicolor:	Multicolor: 1290 --- (except 011 > 018) 1439 --- 26760 --- 26761 --- 26762 ---	diameter= 4mm 1 bobbin of 50lm
	1287 ---		
	1288 ---		
	1289 ---		
	1290 011 > 1290 018		
	1291 ---		
	1291 ---		
	1292 ---		
	1294 ---		
	24806 ---		

Name of the product	Reference	Description	Logistic information
Welding rods	iQ Natural Unicolor: 1296 ---	Multicolor: 1297 ---	diameter= 4mm 1 bobbin of 50lm

SPORT

Name of the product	Logistic information
Welding rods - Omnisports Speed / Compact	diameter= 4mm / 1 bobbin of 50lm 1287--- / 1291--- / 1292---
Welding rods - Omnisports Training / Reference Multi-use / Active / Excel / Pure play	diameter= 5mm / 1 bobbin of 50lm 1285 ---

NON-PVC WELDING RODS

FOR VINYL

Name of the product	Reference	Logistic information
Welding rods	iQ One Unicolor: 21201 ---	diameter= 4mm 1 bobbin of 50lm

FOR LINOLEUM

Name of the product	Reference	Logistic information
Welding rods	Unicolor: 1751 --- Available in stock for the compact linoleum range	diameter= 4mm 1 bobbin of 50lm
Welding rods	Multicolor: 14000 --- Available in stock for the 20 Grands Classiques compact linoleum colours	diameter= 4mm 1 bobbin of 40lm
Welding rods	Unicolor: 14051 --- Available in stock for the acoustic linoleum range	diameter= 4,4mm 1 bobbin of 40lm

TRANSITION PROFILES

EXPANSION JOINTS FOR ROLLS

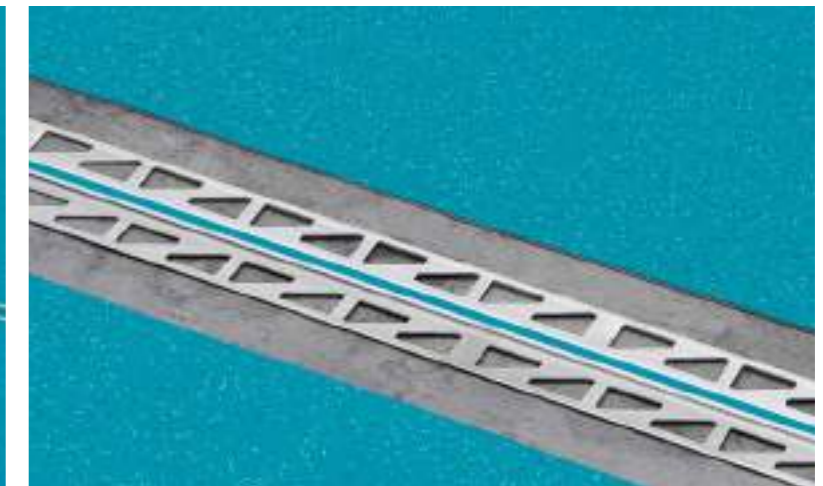
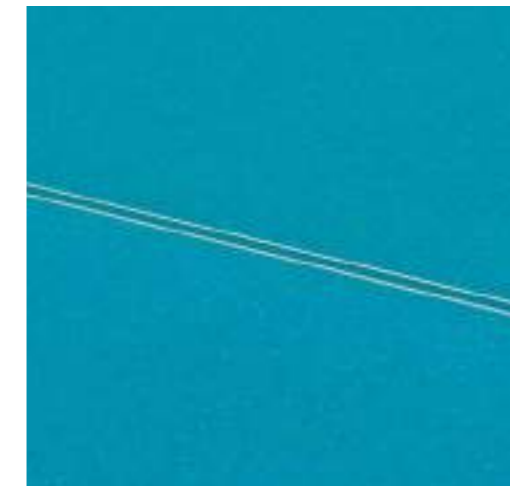

Screed and expansion joints are made in nearly all buildings and have to be taken over by the floor. If no joints are made, the floor covering may tear or dish, which would require complex and costly repair.

Expansion joint sections offer a perfect solution to avoid such problems.

2.3/3.7x 2500mm, made upon request in any colour for perfect matching
Ordering unit: 1 box of 10 pcs = 25lm

Art codes: **Expansion joint 2.2:** 26600 --- (for 2.00mm compact flooring)
Expansion joint 3.7: 26601 --- (for 3.0/3.5mm acoustic flooring)

All Tarkett resilient ranges offer a complete list of matching unicolour or multicolour welding rods according to the design and colour chosen.

Please refer to:

<http://professionals.tarkett.com>

(UNDER PRODUCTS / ACCESSORIES / WELDING RODS)

Build
the future.
Together.



COVINGS

PVC COVE FORMER

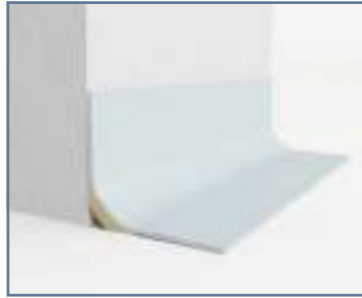

Used to form a cove where floor coverings are continued up the wall. Usually used with a capping seal or cap to finish the raw edge of the floor covering.

Delivery: 25 units of 21m per box

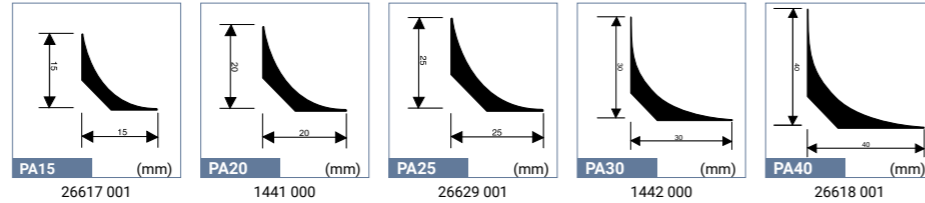

PVC CAPPING



Used to finish the top of a resilient floor covering where it has been covered up the wall. Usually used with a cove former.

CAP1: semi-flexible, cost-effective

CAP2: self-adhesive, easy to install

CAP3: two-parted, hygienic

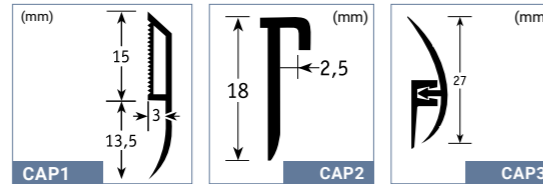

	CAP1	CAP2	CAP3
Medium grey RAL: 5000 NCS: S 5502 B	1443 000	-	-
Light grey RAL: 7500 NCS: S 3000 N	1443 001	-	-
White RAL: 9003 NCS: S 0500 N	1443 002	1444 001	1445 001
Black RAL: 1500 NCS: S 9000 N	-	1444 000	1445 000
Silver	-	1444 002	-
Wood colour matched RAL: 070 80 30 NCS: S 2020 Y 30 R	-	-	1445 002
Delivery	25 units of 2.701m per box	25 units of 2.701m per box	25 units of 2.701m per box

2 IN 1: COVE FORMER & CAPPING



Provides a neat cove allowing floor coverings to be dressed up the wall to form a skirting, supports floor covering at a weak point, and protects the exposed edge.

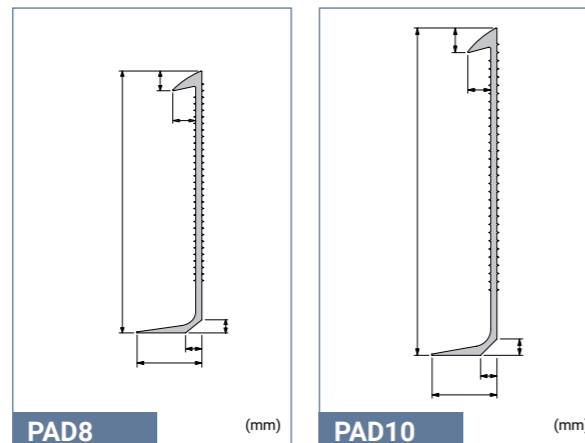

	PAD8	PAD10
Light grey RAL: 7500 NCS: S 3000 N	1438 001	1437 001
White RAL: 9003 NCS: S 0500 N	1438 002	1437 002
Delivery	20 units in 21m per box	20 units in 21m per box

SKIRTINGS

PREFORMED SKIRTING - PVC / LINO

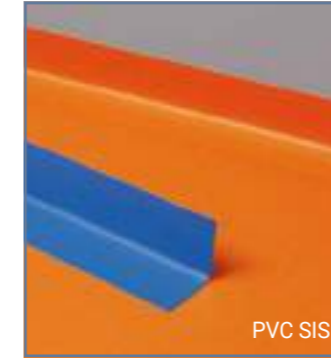

Preformed set-in skirting made of PVC or Linoleum flooring, reinforced with polymer on backside. Welded to the floor covering and glued to the wall. Ensure easy to clean and hygienic result.

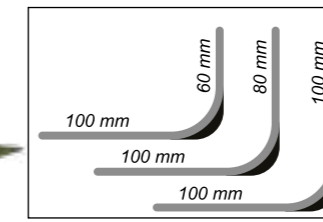
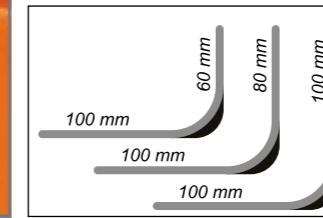

PVC

60/80/100 x 100x2 400mm, available upon request with all colours

Ordering unit: 1 box of 10 pcs = 241m (min order 2 boxes)

Art codes: **Acoustic** 100 x 100mm: 26611 ---
100 x 80mm: 26612 ---
100 x 60mm: 26613 ---

Compact 100 x 100mm: 26614 ---
100 x 80mm: 26615 ---
100 x 60mm: 26616 ---

LINOLEUM

60/80/100 x 100x2 400mm, available upon request with all colours

Ordering unit: 1 box of 10 pcs = 241m (min order 2 boxes)

	Compact 2mm	Compact 2.5mm	Acoustic 3.8mm
100 x 100mm:	1746	1743	1719
100 x 80mm:	1747	1744	1741
100 x 60mm:	1748	1745	1742

Available upon request also on 20 cm, onto the floor

PREFORMED OUTER CORNER - PVC / LINO



Preformed outside corner made of PVC or Linoleum flooring, reinforced with polymer on backside. Welded to the floor covering and glued to the wall. Shock resistant & watertight.

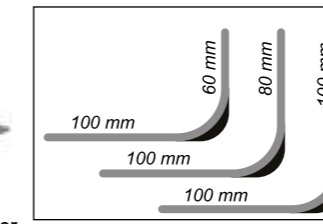
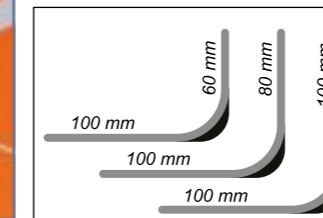

PVC

Shock resistant & watertight outside corner made of Evolution flooring, Polymer reinforced structure. To be glued or welded.

60/80/100 x 100 x 130mm, available upon request with all colours

Ordering unit: 1 box of 10 pcs

Art codes: **Acoustic** 100 x 100mm: 26605 ---
100 x 80mm: 26606 ---
100 x 60mm: 26607 ---

Compact 100 x 100mm: 26608 ---
100 x 80mm: 26609 ---
100 x 60mm: 26610 ---

LINOLEUM

Size of the corner 130x130mm.

Available upon request with all colours.

Ordering unit: 1 box of 10 pieces

	Compact 2mm	Compact 2.5mm	Acoustic 3.8mm
100 x 100mm:	1766	1763	1760
100 x 80mm:	1767	1764	1761
100 x 60mm:	1768	1765	1762

Available upon request also on 20 cm, onto the floor



SKIRTINGS

SEMI-FLEXIBLE DECORATIVE SKIRTING



PVC semi-rigid skirting for decorative use, available in 3 heights:

KS61: 6cm

KS 80: 8cm

KS 100: 10cm

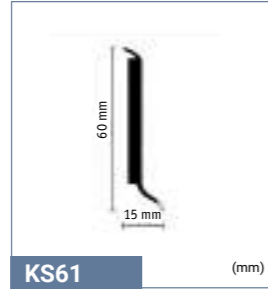

KS61 (mm)

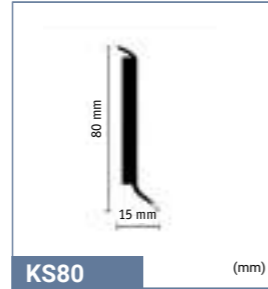

KS80 (mm)

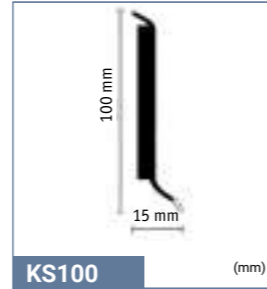

KS100 (mm)

	KS61	
NEW!	Oak long strip natural RAL: 1411 052 NCS: S4020-Y10R	1411 052
NEW!	Concrete cool grey RAL: 1411 053 NCS: S3500-N	1411 053
NEW!	Aluminium RAL: 1411 051 NCS:	1411 051
	White RAL: 9010 NCS: S 0410-R50B	1411 002
	Black RAL: 9004 NCS: S 8500 N	1411 007
	Dark grey RAL: 7043 NCS: S 7500 N	1411 008
	Medium grey RAL: 7012 NCS: S 6502 B	1411 009
	Grey RAL: 7004 NCS: S 4500-N	1411 010
	Light grey RAL: 7500 NCS: S 3500 N	1411 011
	Very light grey RAL: 7035 NCS: S 2002 Y	1411 012
	Light beige RAL: 080 80 20 NCS: S 2010 Y20 R	1411 027
	Beige RAL: 070 60 20 NCS: S 4020 Y20 R	1411 021
NEW!	Dark beige RAL: 1411 054 NCS: S4005-Y20R	1411 054
	Dark brown RAL: 060 40 05 NCS: S 7005 Y50 R	1411 013
	Intense Plum RAL: 1411 049 NCS:	1411 049
	Rose wood RAL: 060 60 10 NCS: S 3010 Y50 R	1411 032

	KS61	
	Grege RAL: 070 80 10 NCS: S 2005 Y40 R	1411 026
	Medium beige RAL: 070 80 30 NCS: S 2020 Y30 R	1411 025
	Bright orange RAL: 1411 047 NCS: S 3040-Y70R	1411 047
	Red RAL: 030 40 60 NCS: S 1080 Y90 R	1411 019
	Bright yellow RAL: 1411 048 NCS: S2050-Y10R	1411 048
	Intense olive RAL: 1411 050 NCS: S3030-G90Y	1411 050
	Green yellow RAL: 100 70 60 NCS: S 2050 G70 Y	1411 036
NEW!	Bright turquoise RAL: 1411 055 NCS: S3040-B40G	1411 055
NEW!	Intense petrole RAL: 1411 056 NCS: S5020-B30G	1411 056
	Green blue RAL: 200 60 20 NCS: S 3030-B50G	1411 044
	Blue green RAL: 190 60 10 NCS: S 3010 B70 G	1411 035
	Sky blue RAL: 230 70 15 NCS: S 2020 B	1411 042
	Medium blue RAL: 250 50 20 NCS: S 4030 R90 B	1411 041
	Dark blue RAL: 270 40 25 NCS: S 5030 R80 B	1411 039
Delivery	20 units of 2.50lm	

	KS80	
	Concrete cool grey RAL: 1411 262 NCS: S3500-N	1411 262
	Dark grey RAL: 7043 NCS: S7500-N	1411 258
	Medium grey RAL: 7012 NCS: S6502-B	1411 259
	Grey RAL: 7004 NCS: S 4500-N	1411 260
	White RAL: 9010 NCS: S 0410-R50B	1411 257
	Dark beige RAL: 1411 261 NCS: S4005-Y20R	1411 261
	KS100	
	Concrete cool grey RAL: 1411 168 NCS: S3500-N	1411 168
	Dark grey RAL: 7043 NCS: S7500-N	1411 164
	Medium grey RAL: 7012 NCS: S6502-B	1411 165
	Grey RAL: 7004 NCS: S 4500-N	1411 166
	White RAL: 9010 NCS: S 0410-R50B	1411 163
	Dark beige RAL: 1411 167 NCS: S4005-Y20R	1411 167

RIGID DECORATIVE SKIRTING WITH MATERIAL TO BE INSERTED



	IS60	
	Medium grey RAL: 5000 NCS: S 5502 B	1448 000
	Light grey RAL: 7500 NCS: S 3000 N	1448 001
	White RAL: 9003 NCS: S 0500 N	1448 002
Delivery	20 units of 2.57lm	

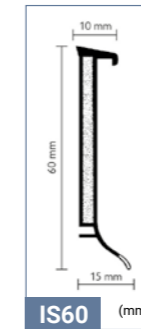

IS60 (mm)

LINOLEUM SKIRTING

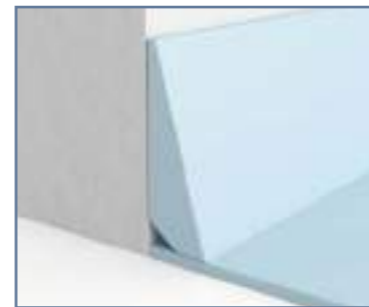

Made with a MDF support for resistance to shocks.
Tailor-made following the colour of the floor.
- 6/8cm high x 220cm long
- Colour upon request
Ordering unit: 1 box with 12 pieces, for 26,40m

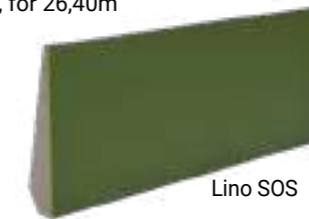

Lino SOS

Description	Product group	
Set on skirting of 6cm for Linoleum with 2.5mm thickness	SOS 25 6 cm	1736
Set on skirting of 8cm for Linoleum with 2.5mm thickness	SOS 25 8cm	1737



SKIRTING SET ON

FLEXIBLE SKIRTING



Flexible PVC skirting used where a neat and clean finishing is required in non critical areas.

	PL6	PL8	PL10
Matched to wood RAL: 070 80 30 NCS: S 2020 Y 30 R	1449 000	1458 000	1450 000
Black RAL: 1500 NCS: S 9000 N	1449 001	1458 001	1450 001
Medium grey RAL: 5000 NCS: S 5502 B	1449 002	1458 002	1450 002
Silver grey RAL: 070 80 10 NCS: S 2005 Y 40 R	1449 003	1458 003	1450 003
Light grey RAL: 8500	1449 004	1458 004	1450 004
White RAL: 9003 NCS: S 0500 N	1449 005	1458 005	1450 005
Delivery	1 unit of 50lm per box	1 unit of 50lm per box	1 unit of 50lm per box

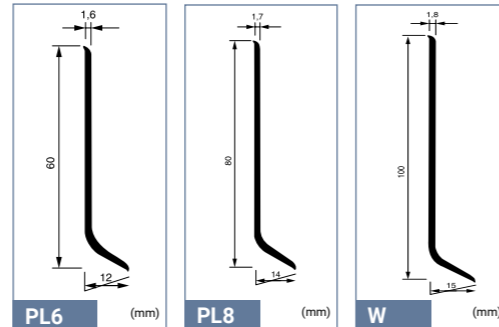

VENTILATED SKIRTING

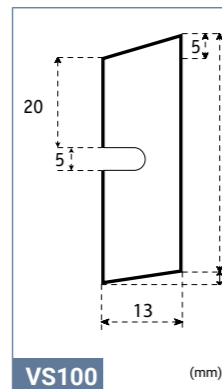
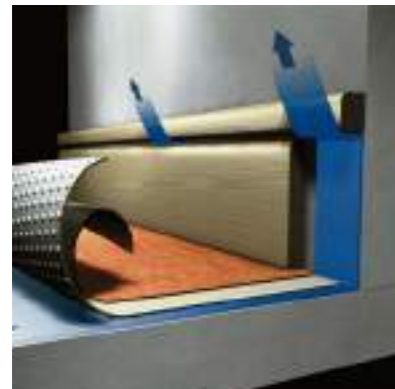

Ventilated skirting made of wood to be painted.
To be used in combination with loose lay floorings or with floor coverings on Tarkolay.
Article code: 1252 030 (unfinished)

PVC RENOVATION SKIRTING



White PVC skirting to be placed over existing skirting in renovation projects avoiding additional handling costs.
Article code: 1411300 (available in one colour = white)

COVING CAPPINGS FOR LVT

LVT SKIRTING CAP



Aluminium skirting cap for LVT Click & Loose-Lay to be combined with skirting bottom.

- To be glued.
- Perfect protection of the edge of the product
- Elegant finish

Size: 20mm wide x 6mm high inside x 8.5mm high outside x 2500 mm long

Packaging: 10 units of 2,5lm in a cardboard box ie 25lm

Article code: 26626 011: silver
26626 012: stainless steel

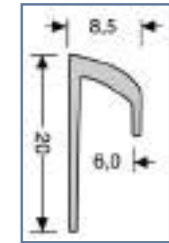

Silver	26626 011
Stainless steel	26626 012

LVT SKIRTING BOTTOM

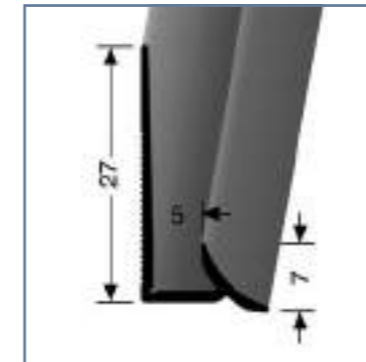

Aluminium skirting bottom for LVT Click & Loose-Lay, to be combined with the cap for skirting.
To be glued.

- Real material to be inserted
- Elegant finish with 100 % color matching with floor covering
- Also compatible for perfect finish in stairs

Size: 5mm inside x 27mm high x 7mm lower lip x 2500 mm long

Packaging: 10 units of 2,5lm in a cardboard box = 25lm

Article code: 26626 021: silver
26626 022: stainless steel

Silver	26626 021
Stainless steel	26626 022

SPECIAL STRIPS DECORATIVE STRIPS FOR LVT

LVT FEATURE STRIPS



Create visual effects with contrasts of colour - to highlight interior features, shape perceptions of room size or personalise your flooring design in plank or tile arrangements.

BLACK	1421 001
SILVER	1421 002
GOLD	1421 003
COPPER	1421 012
EGGSHELL	1421 013
TAUPE	1421 007
DARK GREY	1421 009
ROYAL BLUE	1421 011
RED	1421 010



iD Inspiration Click 55/ 70 High Traffic

LVT Design	LVT Colour	LVT Colour reference (3 last digits)	Skirting reference
PATINA ASH	BROWN	107	26640 344
PATINA ASH	BEIGE	106	26640 343
PATINA ASH	GREY	108	26640 345
CONTEMPORARY OAK	BROWN	112	26640 349
CONTEMPORARY OAK	NATURAL	111	26640 348
CONTEMPORARY OAK	GREGE	110	26640 347
CONTEMPORARY OAK	GREY	109	26640 346
ELM	NATURAL	115	26640 352
ELM	BEIGE	114	26640 351
ELM	LIGHT GREY	113	26640 350
OXIDE	BLACK STEEL	120	26640 361
OXIDE	COPPER	118	26640 359
OXIDE	STEEL	119	26640 360
RUSTIC OAK	LIGHT GREY	124	26640 373
RUSTIC OAK	DARK GREY	122	26640 371
RUSTIC OAK	STONE BROWN	121	26640 370
RUSTIC OAK	MEDIUM GREY	123	26640 372
TERRAZZO	ANTHRACITE	131	26640 380
TERRAZZO	GREEN	130	26640 379
TERRAZZO	GREY	129	26640 378

iD Inspiration Click 55/ 70 High Traffic PLUS

LVT Design	LVT Colour	LVT Colour reference (3 last digits)	Skirting reference
LIME OAK	GREGE	053	26640 766
LIME OAK	DARK GREY	054	26640 767
LIME OAK	LIGHT BEIGE	049	26640 762
LIME OAK	BLACK	056	26640 769
LIME OAK	WHITE	048	26640 761
LIME OAK	BROWN	055	26640 768
LIME OAK	GREY	052	26640 765
LIME OAK	NATURAL	051	26640 764
LIME OAK	BEIGE	050	26640 763
ALPINE OAK	GREY	059	26640 772
ALPINE OAK	NATURAL	057	26640 770
ALPINE OAK	BROWN	058	26640 771
ALPINE OAK	WHITE	061	26640 774
ALPINE OAK	BLACK	060	26640 773
LEGACY PINE	BROWN	157	26640 778
LEGACY PINE	DARK GREY	156	26640 777
LEGACY PINE	MEDIUM GREY	155	26640 776
LEGACY PINE	LIGHT GREY	154	26640 775
ROUGH CONCRETE	GREY	158	26640 780
ROUGH CONCRETE	BLACK	160	26640 782
ROUGH CONCRETE	WHITE	157	26640 779
ROUGH CONCRETE	DARK GREY	159	26640 781

- compact PVC skirting with decorative film and **PUR treatment**, to be glued
- **easy maintenance** with water-resistant material
- perfect finishing with **matching colours** for:

■ all references of **iD Click Ultimate**

Size: 80mm high x 10mm thick x 2020mm long

Packaging: 10 pieces in one box = 20.20lm

iD Click Ultimate 55/70

LVT Design	LVT Colour	LVT Colour reference (3 last digits)	Skirting reference
STYLISH OAK	NATURAL	000	26643 000
STYLISH OAK	GREY	001	26643 001
STYLISH OAK	BEIGE	002	26643 002
STYLISH OAK	WHITE	003	26643 003
LIGHT OAK	BROWN	012	26643 012
LIGHT OAK	LIGHT GREY	013	26643 013
LIGHT OAK	WARM BROWN	014	26643 014
RIVIERA OAK	GREY	015	26643 015
RIVIERA OAK	WARM BROWN	016	26643 016
RIVIERA OAK	LIGHT BROWN	017	26643 017
SOFT ASH	WHITE	018	26643 018
ISOFT ASH	NATURAL	019	26643 019
TIMELESS CONCRETE	ANTHRACITE	021	26643 021
TIMELESS CONCRETE	GREY	022	26643 022
TIMELESS CONCRETE	LIGHT GREY	020	26643 020

TRANSITION PROFILES

PVC PROFILES FOR ROLLS



One piece vinyl transition strip used to join different floorings of the same or slightly different heights. To be glued.

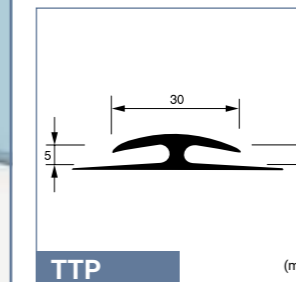

TTP	
Dark grey RAL: 5000 NCS: S 5502 B	1452 000
Light grey RAL: 7500 NCS: S 3000 N	1452 001
White RAL: 9003 NCS: S 0500 N	1452 002
Delivery	2 units of 25lm

ALUMINIUM PROFILES FOR LVT

VERY HIGH TRAFFIC



Aluminium transition strip for LVT Click & Loose-Lay in very high traffic.

- To be screwed.
- Very resistant to very high traffic & rolling loads.
- Ribbed surface for slip-resistance.

Size: 25mm wide x 4/9.5mm high x 2700mm long

Packaging: Full kit including Bottom & Top profiles with screws:
10 units of 2,7lm in a cardboard box = 27lm



Silver NCS:S 2500-N	1451 011
Stainless steel NCS:S 6005-Y20R	1451 012

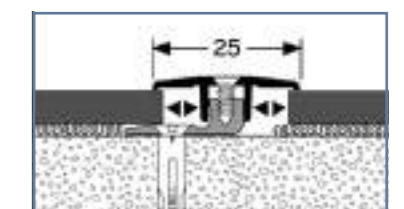

GENERAL TRAFFIC



Aluminium transition strip for LVT Click & Loose-Lay used in general traffic areas.

- To be screwed.
- Elegant finish with smooth surface and no visual screws.
- Bendable with radius 60 cm.

Size: 24mm wide x 6mm high x 2700mm long

Packaging: Full kit including top profiles and dowls.
10 units of 2,7lm in a cardboard box = 27lm



Silver NCS:S 2500-N	1451 021
Stainless steel NCS:S 6005-Y20R	1451 022

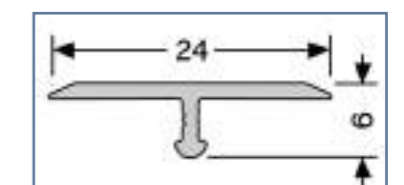

STOP TRANSITION PROFILES

FLEXIBLE RAMP PROFILE FOR ROLLS



Bendable aluminium profiles used to form a joint between different types of floor coverings. Can be manually curved on site to accommodate shaped and radius designs. Two heights available: one for compact floors (FT 2.5) and one for acoustic floors (FT 5). To be glued.

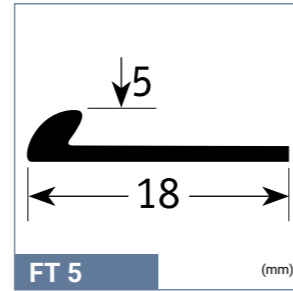
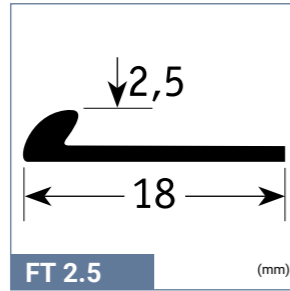

Silver	FT 2.5mm	FT 5.0mm
	1456 000	1456 001
Delivery	10 units of 2.5lm	10 units of 2.5lm

LVT BENDABLE STOP PROFILE



Aluminium stop profile to be screwed.

- Very resistant to wear & traffic
- Ribbed surface for slip-resistance
- Bendable with radius 80cm

Size: 30mm wide x 5mm high inside x 8mm high outside 30mm high x 2500mm long

Packaging: Full kit including stop profiles, screws and dowls.
10 units of 2,5lm in a cardboard box = 25lm

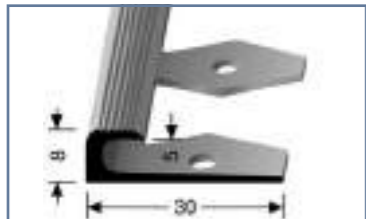

Silver	NCS:S 2500-N	1456 011
Stainless steel	NCS:S 6005-Y20R	1456 012

RAMPS TRANSITION PROFILES

METALLIC RAMP FOR ROLLS



Metallic floor trim providing a neat and simple solution to join floor coverings with major difference in thickness. To be screwed. Compatible with Omnisports floorings and carpet.

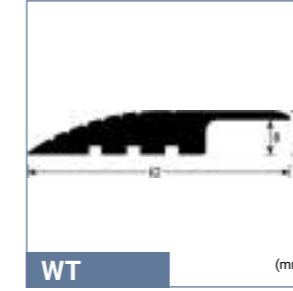

Silver	WT
	1455 000
Delivery	5 units of 3lm

LVT RAMP PROFILE VERY HIGH TRAFFIC



Aluminium transition strip for LVT Click & Loose-Lay used in very heavy traffic areas.

- To be screwed.
- Very resistant to very high traffic & rolling loads – with long ramp to ease transfers.
- Ribbed surface for slip-resistance.

Size: 38mm wide x 5/7mm high x 2700mm long

Packaging: Kit including ramp profile and screws.
10 units of 2,7lm in a cardboard box = 27lm



Silver	NCS:S 2500-N	1454 011
Stainless steel	NCS:S 6005-Y20R	1454 012

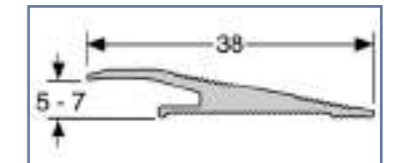

STAIR NOSINGS FOR ROLLS

PVC STAIRNOSE



Flexible PVC stairnose. Cut to size on site and fixed with adhesive before floor covering. Typically used with resilient floor coverings.

NM1: specially designed for round-shaped stair noses, with bending radius 8R.

NM20: designed for slight round-shaped stair noses in housing, with bending radius 4R.

NM45: designed for sharp-angled stair noses, with bending radius 2R, for stairs over 16cm high.

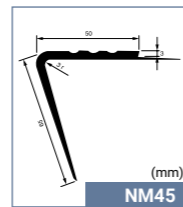
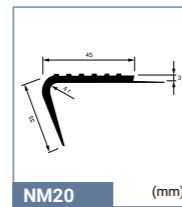
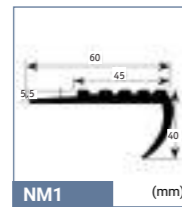

	NM1	NM20	NM45
Black RAL: 9004 NCS: S 8500 N	1401 004	1404 004	1403 004
Medium grey RAL: 7012 NCS: S 6500 N	1401 005	1404 005	1403 005
Light grey RAL: 7040 NCS: S 2500 N	1401 006	1404 006	1403 006
Silver grey RAL: 9002 NCS: S 1502 N	1401 007	1404 007	1403 007
Delivery	12 units of 3m	12 units of 3m	12 units of 3m

ALUMINIUM STAIRNOSE



Aluminium stairnose. To be screwed over the floor covering.

	MS1
Silver	1434 001
Delivery	10 units of 3m

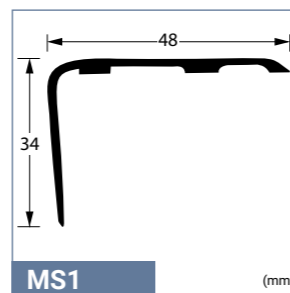

STAIR NOSINGS FOR LVT

LVT CLICK & LOOSE-LAY STAIRNOSE HIGH TRAFFIC



- Aluminium stairnose to be screwed. Very resistant to wear & traffic
- Ribbed surface for slip-resistance
- Elegant finish

Size: 40mm wide x 5mm inside x 2500mm long

Packaging: Full kit including stairnose profile, screws and dowels. 10 units of 2,5m in a cardboard box = 25lm

Silver NCS:S 2500-N	1434 021	Stainless steel NCS:S 6005-Y20R	1434 022
-------------------------------	----------	---	----------

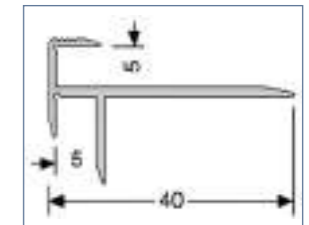

To use with the LVT Skirting Bottom

LVT CLICK & LOOSE-LAY STAIRNOSE VERY HIGH TRAFFIC



- Aluminium stairnose for LVT used in very high traffic areas. To be screwed.
- Very resistant to very high traffic
- Ribbed surface for slip-resistance

Size: 38mm wide x 5/5.5mm inside x 30mm high x 2500mm long

Packaging: Full kit including stairnose profiles, screws and dowels. 5 units of 2,5m in a cardboard box = 12.5lm

Silver NCS:S 2500-N	1434 011	Stainless steel NCS:S 6005-Y20R	1434 012
-------------------------------	----------	---	----------

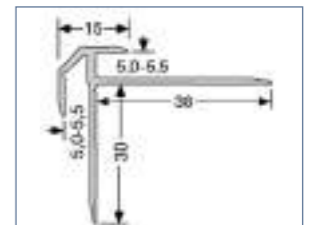

To use with the LVT Skirting Bottom

STAIR CORNERS

INSIDE & OUTSIDE STAIR CORNER



Corners designed to form a neat and attractive edge around the open end of a step by concealing the edge of the floor covering and stair edging. Colour combination with PVC stair nosing.

SB1: used to protect the bottom of the wall alongside the staircase

SB2: used to protect the edge of the floor covering and to hide it

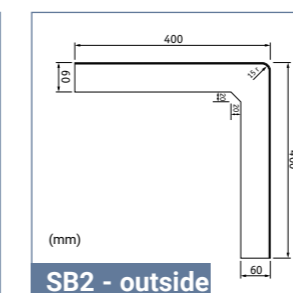
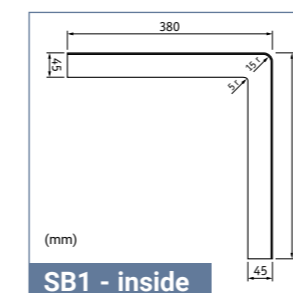

	SB1 interior	SB2 exterior
Black RAL: 9004 NCS: S 8500 N	1432 004	1433 004
Medium grey RAL: 7012 NCS: S 6500 N	1432 005	1433 005
Light grey RAL: 7040 NCS: S 2500 N	1432 006	1433 006
Silver grey RAL: 9002 NCS: S 2500 N	1432 007	1433 007
Delivery	20 units per box	20 units per box



ACCESSIBILITY SAFETY & GUIDANCE

WARNING TILE – TO BE GLUED



Helps recognize a change in level, in accordance with regulatory requirements for disabled access and safety. Various formats available. Self-adhesive or to be glued to the floorcovering (according to product).

Rectangular tiles (to be glued)
Format: 800 x 420 x 7mm
Ordering unit: 1 box of 6 tiles



WS1		
White	RAL: 9010 NCS: S 0500 N	1431 001
Black	RAL: 9004 NCS: S 8500 N	1431 002
Light grey	RAL: 7035 NCS: S 2002 G	1431 003

GLUE-DOWN SYSTEM

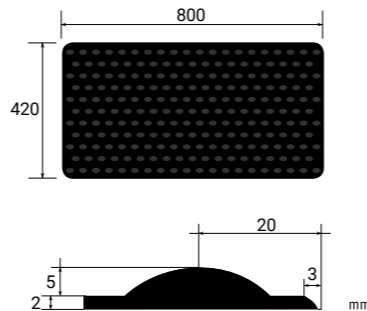

WARNING TILE – SELF-ADHESIVE



Self-adhesive rectangular tiles
Format: 815 x 400 x 7mm
Ordering unit: 1 box of 10 tiles

SELF-ADHESIVE RECTANGULAR TILE

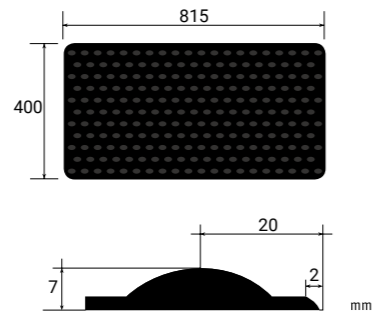

Self-adhesive square tiles
Format: 445 x 400 x 7mm
Ordering unit: 1 box of 10 tiles

SELF-ADHESIVE SQUARE TILE

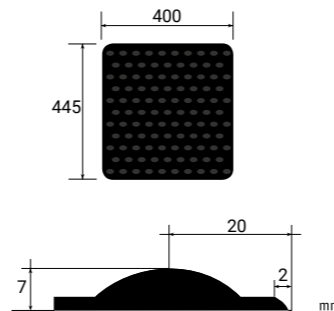

	Self-adhesive	
	Rectangular tile	Square tile
White	1440 350	1440 450
Grey	1440 351	1440 451
Black	1440 352	1440 452
Ivory	1440 353	1440 453
Red	1440 354	1440 454
Yellow	1440 355	1440 455

EASY KIT 3D STUDS

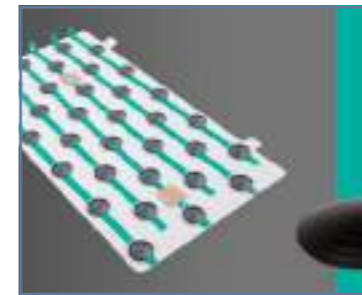

Ready to use self-adhesive warning studs kits for heavy traffic. Kit of 33 studs already pre-mounted in template, allowing the simultaneous installation of 33 studs. Easy, effective and reliable installation.

Format: 42cm
Width: 22,5cm
Height: 5mm
Net weight: 0,13kg
Type kit of 33 studs

Packaging
Pieces per box: 8 kits
Box size: 44x27x7cm
Box weight: 1kg

	Grey	1440551
	Black	1440552

TACTILE STRIPS



Designed for visually impaired people to help finding their way with blind stick. The strip should contrast in colour with the surrounding floor covering to ensure clear visibility.

Tactile strip
(self-adhesive)
Available in rolls
Roll length: 15.24lm
Width: 30.48cm
Thickness: 1.6mm + studs 3.2mm

Linear strip: white stick follows channel
(self-adhesive)
Available in tiles
Format: 625 x 150mm
Thickness: 2mm + studs 3mm

Tactile strip	Self adhesive
Snow White	1440 001
Charcoal	1440 020
Black	1440 040
Ordering unit	1 box of 1 roll = 15.24lm

Linear strip	
	White 1440 250
	Grey 1440 251
	Black 1440 252
	Ivory 1440 253
	Red 1440 254
	Yellow 1440 255
Ordering unit	1 box of 15 strips

SELF-ADHESIVE STRIP IN ROLLS

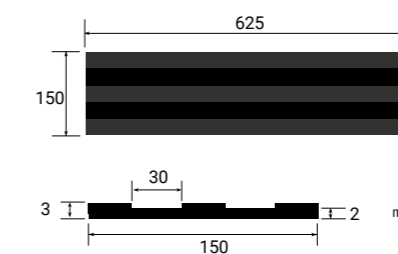

SELF-ADHESIVE LINEAR STRIP

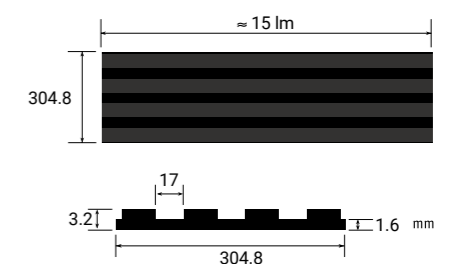

WETROOM

DRAINS

PVC and stainless steel drains and gratings, adapted to various conditions of use: outlet, height, diameter, and outflow.

GRATINGS

PVC

Standard ø150 1417 001

Art Deco ø130 26658 001

Drop ø150 26657 001
Grating "Drop" with hole for pipe

Hole for pipe ø130 26659 001

Hole for pipe ø150 26660 001

Wave ø130 26653 001

Wave ø150 26652 001

Drop ø130 26651 001

Drop ø150 26650001

Art Deco ø130 1417 013

Art Deco ø150 1417 010

INOX

PURUS ITEMS

Brage/Oden water trap 1417 005

Freja water trap 1417 007

Locking set 1417 006

Purus knife 1417 003
Extra blades for Purus knife (x5) 1417 016

DuschBrunn water trap 1417 008

Support 1417 004

Clamping ring: 150mm 1417 002

RECTANGULAR DRAINS

Dimensions
Length: 600, 900mm
Width: 130mm
Note that the height depends on which gully you choose

Bottom outlet

Side low outlet

Side outlet

CLASSIC DRAINS

VERTICAL OUTLET Four models

SIPHON PURUS BRAGE 75
ref. 1416 005 outflow 0.8 L/s

SIPHON PURUS BRAGE 50
ref. 1416 004 outflow 0.8 L/s

SIPHON STAINLESS STEEL 40*
ref. 1416 007 outflow 0.66 L/s

SIPHON PURUS DUSCH BRUNN 50
ref. 1416 001 outflow 0.8 L/s

HORIZONTAL OUTLET Three models

SIPHON PURUS FREJA 50
ref. 1416 002 outflow 0.8 L/s

SIPHON PURUS ODEN 75
ref. 1416 003 outflow 0.8 L/s

SIPHON MINIMAX
ref. 1416 006/ø50mm/outflow 0.8 L/s
ref. 1416 010/ø40mm/outflow 0.8 L/s

Special renovation

FLEXIBLE JUNCTION PROFILES



Flexible PVC junction profiles for wetrooms. Reduce thickness difference between floor rising to the wall and Aquarelle wall coverings.

PJ30 (mm)
1418 001
1 roll of 25lm in one box

PJ40 (mm)
1418 002
1 roll of 25lm in one box

PJ65 (mm)
26661 001
1 roll of 15lm in one box

THRESHOLD TRANSITION FOR WETROOMS



Rubber & PVC transition profiles for wetrooms.

RTS: Rubber. Flattens when doors opens

PTS: PVC. Hot weldable with flooring

RTS

Available in one colour
Grey / ref. 1255 748
1 box = 20lm

PTS

Available in four colours
Grey / ref. 26664 001
Dark grey / ref. 26664 002
White / ref. 26664 003
Beige / ref. 26664 004
1 box = 30lm

WETROOM PIPE COLLARS

WATERPROOF PIPE COLLARS



Offer watertight finish for small diameter pipework in a variety of sizes.

STOSETT LOW TOPMEMBRANE		
Diameter*	Reference	Packaging
8 - 12mm	1420 001	24 sleeves + 12 clamps
11 - 15mm	1420 002	24 sleeves + 12 clamps
15 - 19mm	1420 003	24 sleeves + 12 clamps
18 - 22mm	1420 004	24 sleeves + 12 clamps
21 - 26mm	1420 005	24 sleeves + 12 clamps
26 - 31mm	1420 006	24 sleeves + 12 clamps
30 - 35mm	1420 007	24 sleeves + 12 clamps
35 - 42mm	1420 008	6 sleeves + 3 clamps
100 - 127mm	1420 009	1 sleeve
Adhesive for Stosett	1460 100	1 tube = 160lm

* The first figure indicates the diameter of the upper part; the second indicates the diameter at the groove.

TARKETT MATERIAL DESCRIPTION	
26687101	Siphon Vinyl Plus Chess Ø50 side 600mm
26691101	Siphon Vinyl Plus Chess Ø50 side low 600mm
26689101	Siphon Vinyl Plus Chess Ø75 side 600mm
26688101	Siphon Vinyl Plus Chess Ø75 bottom 600mm
26693101	Siphon Vinyl Plus Chess Ø50 side 900mm
26697101	Siphon Vinyl Plus Chess Ø50 side low 900mm
26695101	Siphon Vinyl Plus Chess Ø75 side 900mm
26694101	Siphon Vinyl Plus Chess Ø75 bottom 900mm



PROTECTWALL

CAPS

Aluminium and PVC caps (flexible and solid) to provide a perfect finish and protect the edge of the wall covering.

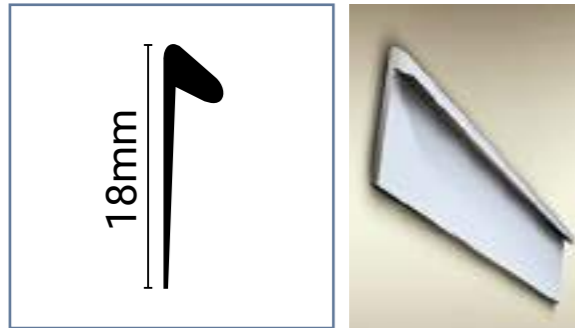

ALUMINIUM CAP 2.5

Self adhesive
3.5mm (ext.) x 2.5mm (int.) x
18mm x 2500mm

Delivery:
1 box of 10 pcs = 25lm

Silver NCS:S 2500-N	26621 001
Stainless steel NCS:S 6005-Y20R	26621 002

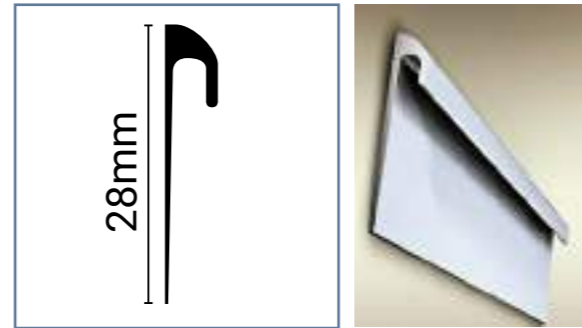

ALUMINIUM CAP 3

Self adhesive
5.2mm (ext.) x 3mm (int.) x
28mm x 2500mm

Delivery:
1 box of 10 pcs = 25lm

Silver NCS:S 2500-N	26626 001
Stainless steel NCS:S 6005-Y20R	26626 002

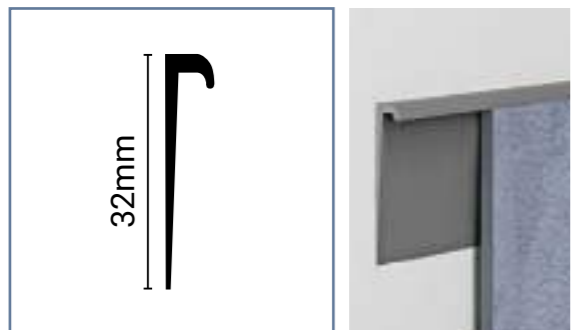

SOLID PVC CAP

32mm x 4.5mm (ext.) x
2.5mm x 2500mm

Delivery:
1 box of 20 pcs = 50

White RAL: 9010 NCS: 1940	26619 001
Beige NCS: S 40-Y30R	26619 002
Brown RAL: L8014V	26619 003
Light Grey NCS: S 4000N	26619 004
Silver RAL: 9022	26619 005

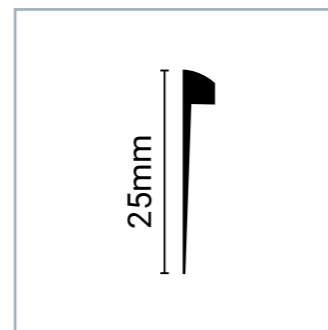

FLEXIBLE PVC CAP

6mm (ext.) x 2.5mm (int.)
x 25mm x 25m

Delivery: 1 roll 25lm

Caramel NCS: S 3010-Y30R	26620 001
Dark Grey RAL: 7012 NCS: S 6502-B	26620 002
Light Grey RAL: 7038 NCS: S 3000-N	26620 003
White RAL: 9010 NCS: 1940	26620 004
Aluminium NCS: S 3005-R80B	26620 005

SET-ON CORNERS

Aluminium and flexible PVC outside corners used to protect the external corner of walls vs impacts and provide neat finish. Installed over the wall covering.

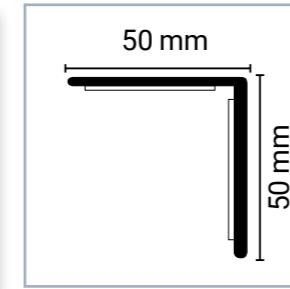

SOLID PVC 90°

Self adhesive
50mm x 50mm x 1000mm

Delivery:
20 pcs in each pack = 18lm

White NCS: S 0603-R80B	26625 101
Light Grey NCS: S 2002-Y50R	26625 102
Light Beige NCS: S 1505-Y	26625 104
Medium Beige NCS: S 1010-Y30R	26625 105

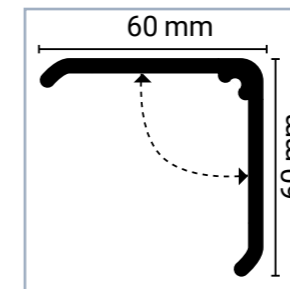

ADJUSTABLE PVC CORNER

Self adhesive
60° à 130°
60mm x 60mm x 2700mm

Delivery:
20 pcs in each pack = 18lm

White NCS: S 0603-R80B	26627 101
----------------------------------	-----------

SET-IN CORNERS

Aluminium and flexible PVC outside corners (flexible and solid) used to protect the external corner of walls vs impacts and provide neat finish. Installed under the wall covering.

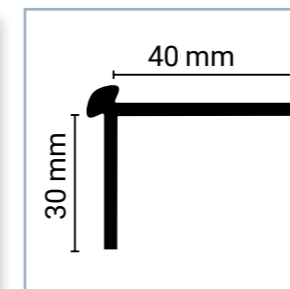

ALUMINIUM

30mm x 40mm x 4.5mm (ext.)
x 2.5mm (int.) x 2500mm

Delivery:
1 box of 10 pcs = 25lm

Silver	26624 001
Stainless steel	26624 002

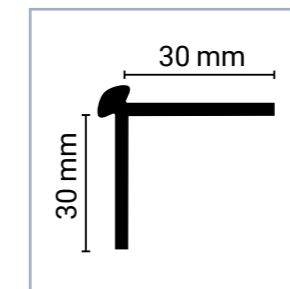

FLEXIBLE PVC

30mm x 30mm x 4.5mm (ext.)
x 2mm (int.) x 2500mm

Delivery: 1 roll 25lm

Caramel NCS: S 3010-Y30R	26623 001
Dark Grey RAL: 7012 NCS: S 6502-B	26623 002
Light Grey RAL: 7038 NCS: S-3000 N	26623 003
White RAL: 9010 NCS: 1940	26623 004
Aluminium NCS: S 3005-R80B	26623 005



SOLID PVC

22.2mm x 20mm x 2.2mm (int.)
x 2600mm

Delivery:
1 box of 20 pcs = 52lm

White RAL: 9010 NCS: S 0603-R80B	26622 001
---	-----------



UNDERLAYERS

WET SUBSTRATE



Tarkolay

- Quicker and more cost-effective solution that copes with up to 7% humidity rate CCM.
- Quick and easy to install and ready-to-use solution.
- Loose-lay and easy to remove solution not to damage the substrate.

Material: PVC coated glass fibre with 0.30mm thick studs
Total weight: 1,160g per m²
Total thickness: 1.3mm
Article code: 3960 004 - Blue

Compatible with: Heterogeneous & Homogeneous vinyl (rolls)

UNEVEN SUBSTRATE & FLOOR PRESERVATION



Tarkoflat Loose-lay

- Ready-to-use solution to reduce slight unevenness by up to 1.5mm depth.
- Ideal choice to protect floor during temporary installations.
- Quick and easy to install solution.

Material: calandered PVC foil, loose-lay (naked)
Total weight: 1,500g per m²
Total thickness: 1.0mm
Article code: 3568 004 - Grey

Compatible with:
 - LVT click and LVT glued in residential and light commercial* applications (planks and tiles)
 - Vinyl rolls for temporary installations (up to one month)



Tarkoflat Self-adhesive

- Ready-to-use solution to reduce slight unevenness by up to 1.5mm depth.
- Quick and easy to install solution.
- Environmentally-friendly solution (no adhesive needed).

Material: calandered PVC foil, loose-lay (naked)
Total weight: 1,500g per m²
Total thickness: 1.0mm
Article code: 3569 004 - Grey

Compatible with: LVT glued (planks and tiles) in residential applications

FAST TRACK RENOVATION SYSTEMS



Jumpax®

- Revolutionary solution for levelling performance offering exceptional stability and resistance.
- Quieter and harder-wearing underlayer, reducing noise by 23 dB with linoleum flooring (21 dB with LVT flooring).
- Unparalleled ease of installation and removal, leaving no residue.

Material: MDF, polystyrene foam covered with aluminium film
Total density: 585Kg/m³
Total thickness: 10mm
Article code: 2499 3010

Compatible with:
 - LVT click, glued and loose-laid (planks and tiles)
 - Homogeneous and heterogeneous flooring (rolls)
 - Linoleum (rolls)



Marathon Dual®

- The ready-to-use solution for renovating over an existing subfloor.
- Easy to install and remove thanks to its simple loose-lay solution.
- Superior performance in impact sound reduction (23dB) and indentation.

Material: MDF and coniferous woods
Total density: 240Kg/m³
Total thickness: 6mm
Article code: 2499 3020

Compatible with:
 - LVT click and loose-laid (planks and tiles)
 - Heterogeneous loose-laid flooring (rolls)

* Please contact your technical service



UNDERLAYERS FOR ACOUSTIC COMFORT



Tarkomfort Premium

- High-performance acoustic insulation: high-impact sound reduction (19 dB with iD Inspiration Click) and in-room noise reduction (72 dB).
- High-performance solution to improve static indentation resistance (0.18mm with iD Inspiration Click).
- Quick and easy to install.

Material: viscoelastic polymer based on polyolefins and EVA
Total weight: 100g per m²
Total thickness: 1mm
Article code: 2499 2030 - Black

Compatible with: iD Inspiration Click (planks and tiles)



Elafono

- High-performance acoustic insulation: in-room noise (up to 65 dB) and impact sound (up to 15 dB) reduction with any compact linoleum.
- 100% natural.
- Superior performances in static indentation, thermal resistance and underfoot comfort.

Material: cork linoleum underlayer
Total weight: 1.450g per m²
Total thickness: 2.0mm
Article code: 1861 030 - Brown

Compatible with:
 - Compact Linoleum (rolls)
 - Homogeneous vinyls (rolls)



Tarkomfort Pro

- Powerful acoustic insulation, reducing both impact sound and in-room noise (13dB).
- Enhanced durability thanks to its high-density, heavy-duty composition (1,500g per m²).
- Simple to install solution with woven anti-slip surface to grip floor covering.

Material: siliconised PET carrier film with high-resistance polyurethane layer and non-woven white fleece backing
Total weight: 1.500g/m²
Total thickness: 1.5mm
Article code: 2499 2020

Compatible with: LVT click (planks and tiles)



Tarkomousse

- Improved acoustic comfort in wet areas: in-room acoustic performance by up to 19dB (Granit Multisafe).
- Greater walking comfort.
- Superior durability.

Material: PVC foam
Total weight: 1.200g per m²
Total thickness: 2.0mm
Article code: 3965 001 - Grey

Compatible with: Wetroom floorings



Tarkomfort Self-adhesive

- High-class solution for reducing both impact sound and in-room noise.
- 90% natural raw materials, free from plasticizers and heavy metals.
- Resistance to high-traffic thanks to its high-density material.
- Quick & easy installation with self-adhesive surface.

Material: transparent PET-foil and heavy-duty polyurethane layer, with mineral fillers and polyurethane binders
Total weight: 2.600g/m²
Total thickness: 1.80mm
Article code: 2499 2040

Compatible with: LVT glued and loose-laid(planks and tiles) in residential and light commercial areas*

* Please contact your technical service



FLOORCRAFT

FLOORCRAFT THE PROCESS

In every building, the floor covering can have a huge influence on the look and feel of the entire environment. The FLOORCRAFT Design Service helps designers, architects, planners and building owners to make the most of this creative opportunity. This service offers almost limitless scope for stunning effects and eye-catching concepts. Launched in 1993, FLOORCRAFT is a unique and increasingly versatile service facility. Each idea is explored and visualised. When the final design is approved, it is translated into a computer program for precision cutting.

However simple or complex the original design brief, the service offers clients proven versatility. Our experienced team is ready to apply their FLOORCRAFT's skills to your project, building on your ideas and helping to bring them to life. The sonic cut components are manually assembled into panels and clear adhesive tape is placed on the surface to hold the pieces together during installation and removed once the flooring adhesive has set. A detailed plan is provided with all panels labelled. Larger features will be supplied in multiple panels. Sonic cutting can be used to create intricate designs that will fit together precisely.



- The sonic blade oscillates at 20,000 cycles per second. This creates a sonic wave around the blade.
- As the blade approaches the flooring product, molecules move apart in the flooring and a cut line is created with no loss or damage to the material surface.
- The computer program controls the position of each cut line and also the pattern consistency.
- The individual pieces are then assembled for a perfect fit.



1 Initial Sketches are developed into final designs.



2 Final designs are drawn using computer software to produce cutting programs.

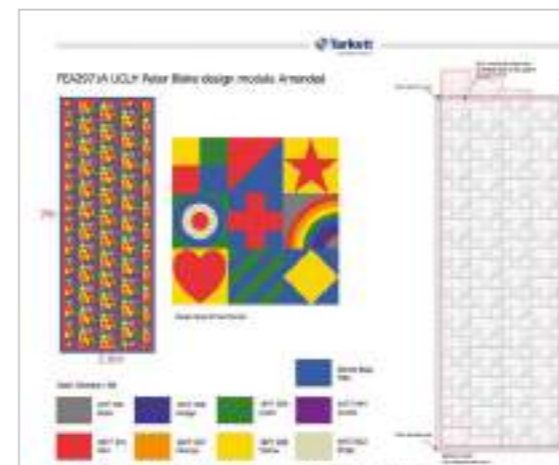

3 Detailed plans make installation easier.



4 Cutting programs are transferred to our sonic cutting machines.



5 The cut pieces are then assembled in our factory.



6 Ready to be sent to the site for installation.





FLOORCRAFT DESIGN LIBRARY

The FLOORCRAFT Design Library has an extensive range of standard designs that can be implemented in any colour, and with practically any flooring in the Tarkett portfolio (please see you local sales rep for complete up to date list). You can also choose to provide us with your own design or to create a design together with our designers.

The appearance of the floor can be emphasised by using imaginative decorative borders. In addition to aesthetic appeal, these designs can also be used to define different areas, or to indicate a path for pedestrians.

BORDERS & BLOCKS

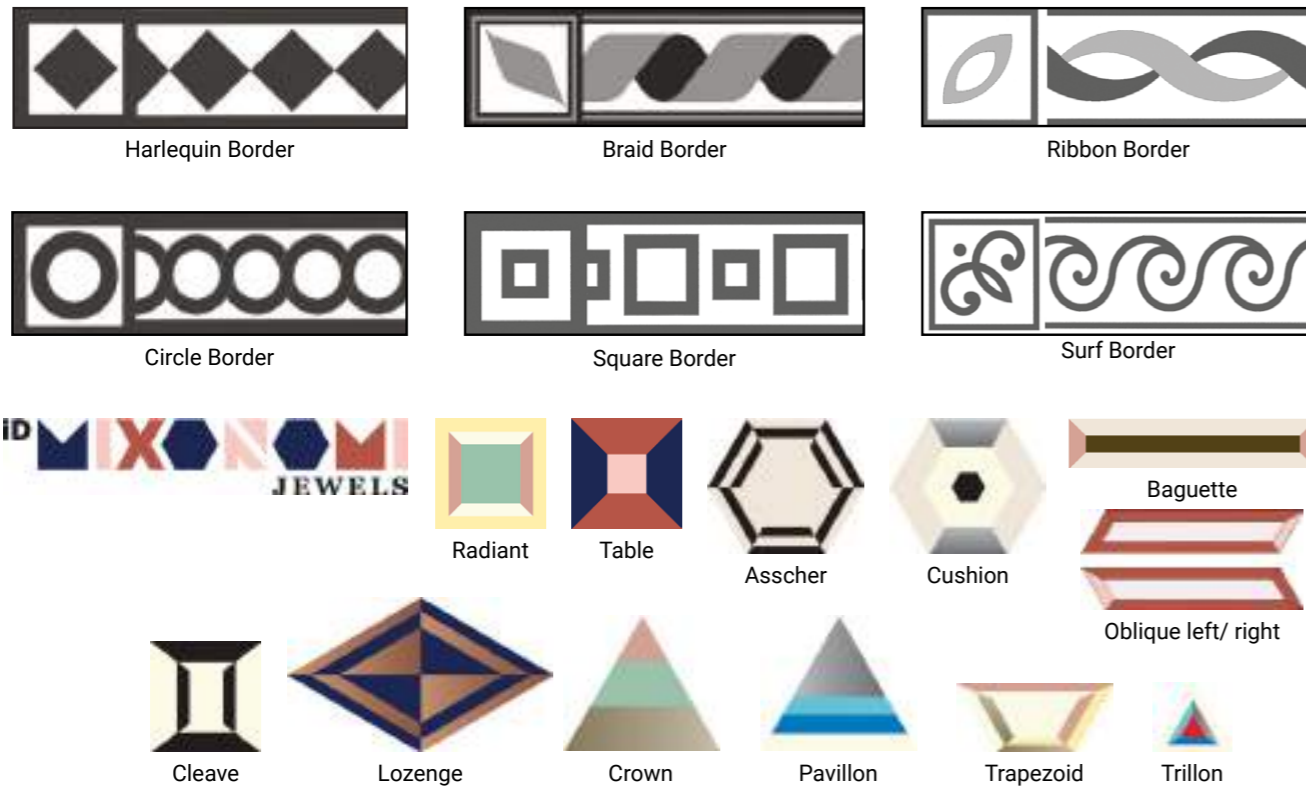

DESIGN FLOORS, REGISTERS & ROSETTES

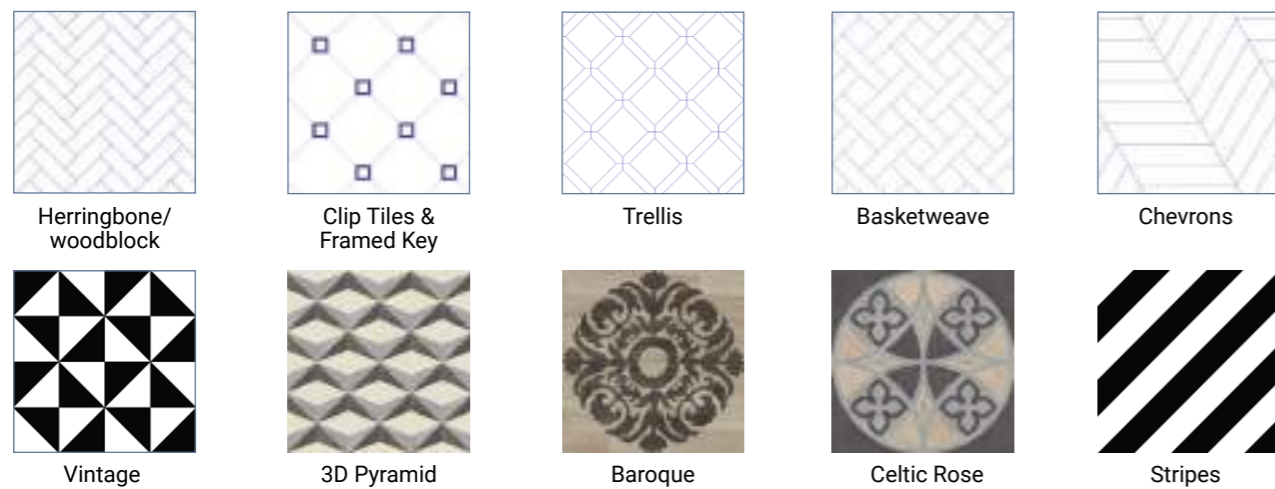

LOGO'S, WAYFINDING & DECORATIVE FEATURES

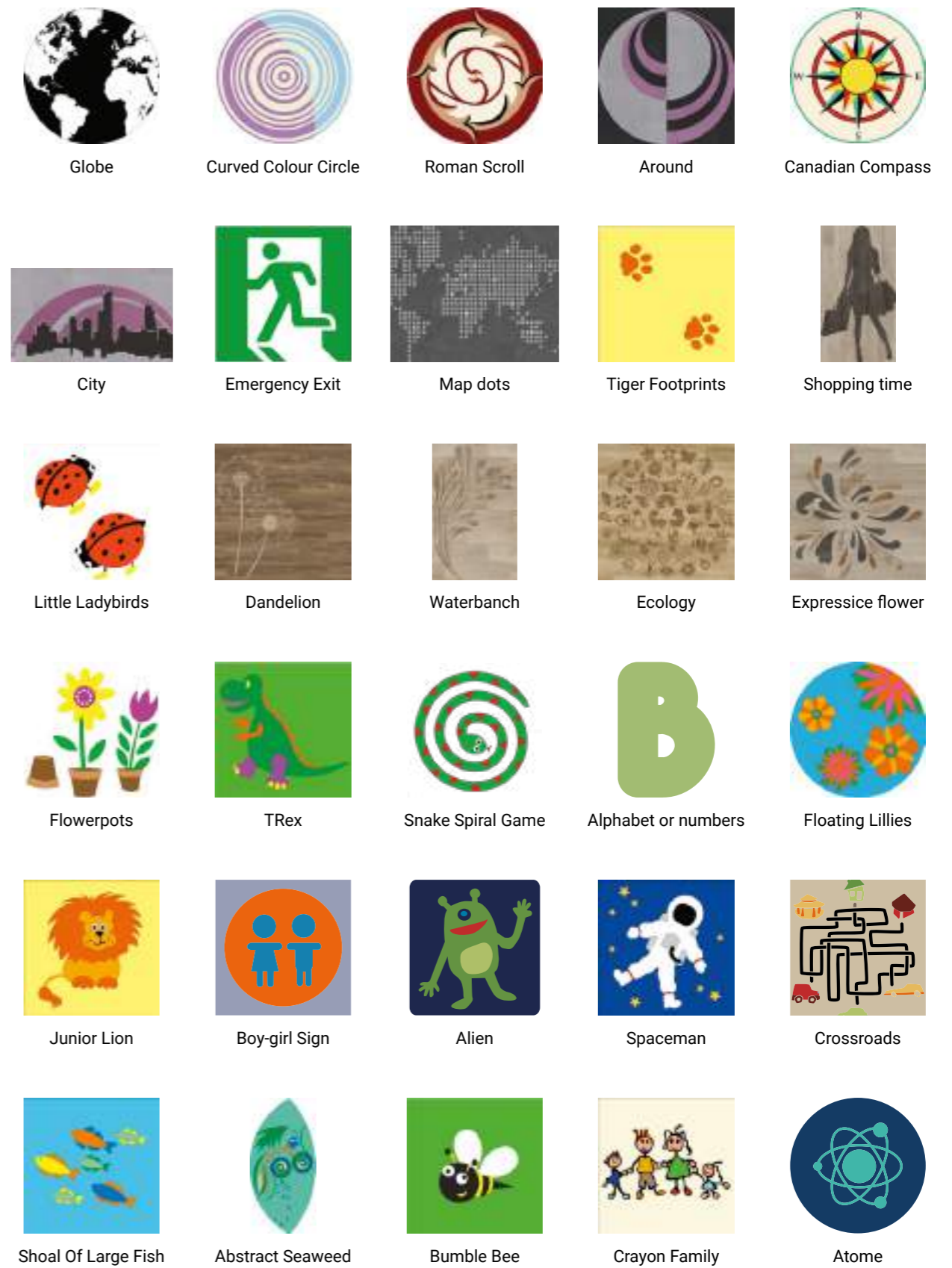

ACCESSORIES FOR HARD FLOORINGS

MATCHING ACCESSORIES WOOD





Tarkett offers a wide selection of accessories to complete the appearance of your wooden floor.

Since wood is a living material you should always leave a space – an expansion gap – of 1.5mm per metre of floor, or at least 8–10mm between the floor and walls, thresholds, pipes, steps, fireplaces, stone floors etc. The expansion gap can be concealed using skirtings, mouldings and pipe collars. Clipstar and Alustar veneer skirtings are available

in a large assortment of wood species. Clipstar is extremely user-friendly: the skirtings are simply mounted on clips that are attached to the wall separately. Alustar, aluminium covered with veneer for high stability and durability, is suitable for high traffic areas. The reducer can also be used as a T-profile.

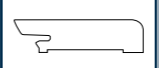



Matching surface finish
Regardless of surface treatment you'll be able to find matching skirtings.

VENEER SKIRTINGS	CLIPSTAR - VENEER			ALUSTAR - ALUMINIUM/ VENEER		QUADRANT
	Skirting			Reducer	End Profile	Quadrant
						
DIMENSIONS	60 x 16 x 2400mm	80 x 16 x 2400mm	60 x 22 x 2400mm	43 x 8 x 900mm	34 x 8 x 900mm	20 x 20 x 2400mm
Ash	8791 738			8791 928	8791 957	
Birch	8791 783			8791 974	8791 981	
Maple	8791 742			8791 932	8791 961	
Beech	8791 744			8791 933	8791 962	
Oak	8791 734	8791 760	8791 770	8791 910	8791 939	8791 996
Oak Brushed	8791 843			8791 911	8791 940	
Walnut	8791 745			8791 934	8791 963	
White Foiled	8791 740			8791 935	8791 964	8791 998
Ash Ivory	8791 852			8791 931	8791 960	
Ash White Pearl	8791 842			8791 930	8791 959	
Ash White	8791 741			8791 929	8791 958	
Oak Snow Flake	8791 784			8791 992	8791 987	
Oak Cotton White	8791 841			8791 914	8791 943	
Oak White Light	8791 853			8791 913	8791 942	
Oak Lime Stone	8791 845			8791 915	8791 944	
Oak White	8791 736			8791 912	8791 941	
Oak Soft Beige	8791 785			8791 983	8791 988	
Oak Blonde	8791 846			8791 916	8791 945	
Oak Winter	8791 839			8791 938	8791 967	
Oak Urban Grey	8791 851			8791 927	8791 956	
Oak Warm Grey	8791 854			8791 924	8791 953	

VENEER SKIRTINGS	CLIPSTAR - VENEER			ALUSTAR - ALUMINIUM/ VENEER		QUADRANT
	Skirting			Reducer	End Profile	Quadrant
						
DIMENSIONS	60 x 16 x 2400mm	80 x 16 x 2400mm	60 x 22 x 2400mm	43 x 8 x 900mm	34 x 8 x 900mm	20 x 20 x 2400mm
Oak Cloud Grey	8791 787			8791 985	8791 990	
Oak Light Grey	8791 757			8791 923	8791 952	
Oak Evening Grey	8791 849			8791 925	8791 954	
Oak Dark Grey	8791 756			8791 922	8791 951	
Oak Dove Grey	8791 777			8791 968	8791 975	
Oak Soft Grey	8791 781			8791 972	8791 979	
Oak Old Grey	8791 850			8791 926	8791 955	
Oak Concrete	8791 779			8791 970	8791 977	
Oak Graphite	8791 789			8791 993	8791 995	
Oak Stone Grey	8791 832			8791 936	8791 965	
Oak Almond	8791 786			8791 984	8791 989	
Oak Praline	8791 834			8791 937	8791 966	
Oak Umber Brown	8791 847			8791 920	8791 949	
Oak Italian Brown	8791 788			8791 986	8791 991	
Oak Cumin	8791 758			8791 919	8791 948	
Oak Old Brown	8791 848			8791 921	8791 950	
Oak Charcoal	8791 780			8791 971	8791 978	

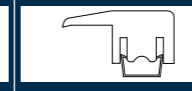
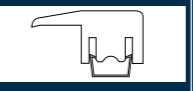
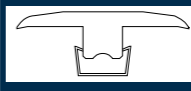
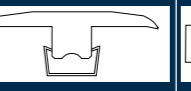
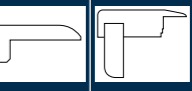











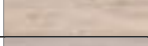

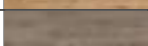

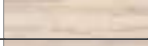
CLIPS FOR CLIPSTAR SKIRTINGS

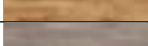
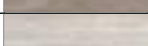
50 clips in a box		8791 800
-------------------	---	----------

SOLID PROFILES	TRANSITION MOULDING						END COVER	STAIRNOSE		
	Reducer		Square		Threshold		End Cover	Stairnose		
										
FLOOR THICKNESS	13-17mm	8-12mm	13-17mm	8-12mm	13-17mm	8-12mm		13-14mm	8,5mm	13-14mm
DIMENSIONS	58 x 19 x 2000mm	44 x 12 x 2000mm	38 x 19 x 2000mm	32 x 12 x 2000mm	58 x 20 x 2000mm	44 x 12 x 2000mm	21 x 9 x 2000mm	66 x 20 x 2000mm	48 x 19 x 2000mm	60 x 26 x 2000mm
Oak	8791 107	8791 126	8791 136	8791 144	8791 157	8791 175	8791 300	8791 446	8791 505	8791 466
Oak Unfinished	8791 105		8791 134		879 1156					8791 465

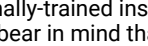

STAIR NOSING SOLUTION

		Coordinated stair nosing	Top stair nosing
			
		14 x 43 x 51,4 x 1950mm	14 x 40 x 51,4 x 1950mm
Heritage Oak Opal White		8795021	8795221
Heritage Oak Lime Stone		8795022	8795222
Heritage Oak Urban Grey		8795023	8795223
Heritage Oak Blonde		8795024	8795224
Heritage Oak		8795025	8795225
Heritage Oak Old Grey		8795026	8795226
Heritage Oak Old Brown		8795027	8795227
Prestige Ash Seashell		8795033	8795233
Prestige Oak White Sand		8795029	8795229
Prestige Oak		8795031	8795231
Prestige Oak Granite		8795041	8795241
Vintage Oak Copenhagen		8795034	8795234
Vintage Oak Uppsala		8795035	8795235
Vintage Oak Lund		8795036	8795236
Vintage Oak Orléans		8795037	8795237
Vintage Oak Montpellier		8795038	8795238
Vintage Oak Chester		8795039	8795239
Vintage Oak Salamanca		8795040	8795240

For the best results, use a professionally-trained installer. (Staircase installation instructions available at www.tarkett.com).
When ordering stair nosings, please bear in mind that a typical staircase is 900 mm wide with 14-17 steps.
As our stair nosings have the same composition as our standard floors, you can use the maintenance and technical data sheet for the relevant floor. All stair nosings are treated with hardwax oil and will require regular maintenance.
To give your installation the final touch, we recommend our hardwax oiled floor repair kit.

PIPE COVERS IN SOLID WOOD		17,1 mm	22,0 mm
Oak		8791 810	8791 811
Oak Unfinished		8791 825	8791 826
Beech		8791 812	8791 813
Ash		8791 814	8791 815
Maple		8791 816	8791 817
Dark (stained)		8791 818	8791 819

DOUBLE PIPE COVERS IN SOLID WOOD

Holes to be drilled afterwards

Oak		8791 820
Oak Unfinished		8791 827



UNDERLAYERS FOR WOOD

SOLUTION FOR UNEVEN FLOOR & ACOUSTIC COMFORT



Tarkoflex II

- High-Effective and immediate solution to reduce smaller bumps and indentations
- Extreme durability thanks to its polyethylene foam and its high-density composition
- High-impact sound reduction, up to 17dB according to the norm

Material: Polyethylene foam with a 100µ moisture-barrier film
Total weight: 150g per m²
Total thickness: 2.0mm
Article code: 8790312 / 8790316

Compatible with: Wood floorings (planks)



Tarkofoam II

- Reduction of slight unevenness
- High durability thanks to its polyethylene foam material
- High-impact sound reduction, up to 17dB according to the norm

Material: Polyethylene foam
Total weight: 60g per m²
Total thickness: 2.0mm
Article code: 8790314 / 8790315

Compatible with: Wood floorings (planks)



TARKOPROOF SEALING SOLUTION

WATER TIGHTNESS LIQUID SEALANT SOLUTION FOR CLICK MODULAR PRODUCTS

DESCRIPTION

Tarkoproof, liquid sealant solution designed for Tarkett click modular solutions, to ensure 100% water-tightness for continuous and/or extreme water conditions. Normal uses in kitchens and bathrooms do not require specific sealing treatment.

Waterproofing solution for 100% water-tightness

To optimize the installation in wet areas, Tarkett has created Tarkoproof, a liquid sealant solution designed for Tarkett click modular solutions. Tarkoproof will prevent any dust or water penetration into the bevels thus ensuring an ease of maintenance and an improved durability for the Tarkett modular floors.

USP:

100% watertight installation
Fast drying time
Easy to handle

Compatible floors:

Cementi Click, LVT, Laminate & all modular click solutions from Tarkett

Main segments of application:



TECHNICAL INFORMATION

Product	Tarkoproof
Linear meter per tube	125
Linear meter to apply per tube	15 to 25

Packaging

Pieces per box	12 tubes
Box size (mm)	201 x 136 x 130
Box weight (kg)	1,8
Min. order	One box of 12 tubes

Custom Code

SAP code	1490001
----------	---------

INSTALLATION

Before assembling the panels apply the solution in a continuous and homogeneous way on the top side of the click. Assemble immediately the panels together after application, creating an overflow of the solution on top of the joints. After 15 to 30 minutes of drying time, remove the solution overflow with a soft plastic spatula.

Silicone joint for waterproof installation

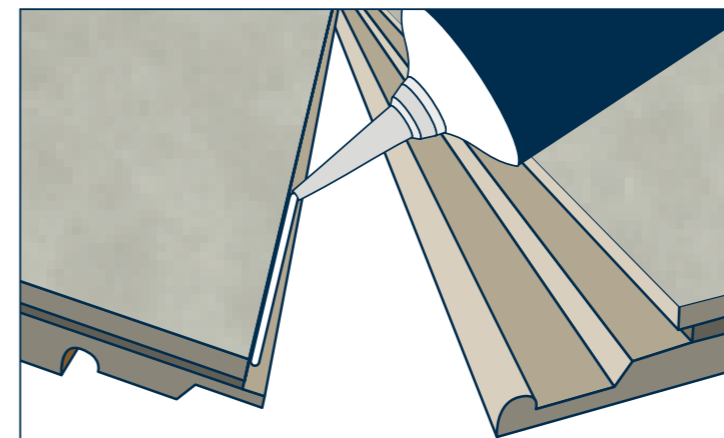

CLEANING & MAINTENANCE

Clean and maintain your floor using the standard procedure



ACCESSORIES FOR SPORTS FLOORINGS

RESILIENT FINISHING ACCESSORIES

WOOD VENTILATED SKIRTINGS



Specific wood varnished skirting with spaces made to allow cross ventilation of the vinyl flooring when installed with GreenLay® method.

	Wood Ventilated Skirting	
	(standard)	(wide)
Oak varnished	1551067	1551068
Beech varnished	1551065	1551066
Maple varnished	1551069	1551070

Wood Ventilated Skirting (standard)
1 box of 5 units = 11.75 lm
Thickness: 22mm
Width: 65 mm
Length: 2350mm

Wood Ventilated Skirting (wide)
1 box of 4 units = 9.40 lm
Thickness: 27mm
Width: 84 mm
Length: 2350mm

VINYL SKIRTINGS



Flexible PVC skirting for Omnisports range used in sports halls to finish the installation. Available in 5 colours and 3 wood species.

1 box of 20 pcs = 51.40lm
60mm high x 15mm wide x 2570mm long

Characteristics	Article code
Beech	1551064
Maple	1551062
Oak	1551063
Royal blue	1551061
Sky blue	1551059

THRESHOLD STRIP



Aluminium one-piece transition strip used to join the sport flooring to surrounding floorings. Reinforced for heavy loading and striated for better grip. 4 different sizes to match various thickness differences. To be screwed.

60 or 80mm wide: 1 box of 10 pcs = 30lm
100 or 130mm wide: 1 box of 5 pcs = 15lm
5mm high x 3000mm long

Characteristics	Article code
60mm wide	1551078
80mm wide	1551079
100mm wide	1551080
130mm wide	1551081

ADAPTABLE TRANSITION STRIP



Aluminium adaptable transition strip for floorings with leveling up to 14mm. Striated for a better grip. To be screwed.

1 box of 10 pcs = 27lm
41mm high x 2700mm long
Article code: 1551071

RESILIENT INSTALLATION ACCESSORIES

LINOFINISH



PU finish for Linosport Classic (4mm), ensuring sports performance and resistance of the surface. To be applied in situ.

Linofinish Kit
(5 liters Primer Can + 2 cans of 5 liters of Linofinish to be mixed with the Linofinish hardener)
Article code: 1551083

GREENLAY® INSTALLATION KIT

Specifically adapted to ensure the durability of GreenLay® installation.

GreenLay® glue: Used to form a cove where floor coverings are contined up the wall.
2 components (A+B), 1 pot of 5kg each

Component	Article code
A	1551057
B	1551058

Tarkotape: Used to reinforce junction between 2 rolls.
1 box of 12 tapes (15cm x 33lm)
Article code: 1551085

TABLE TENNIS



Double-tape unroller enabling the application of double-tape and the assembly of the 2 vinyl rolls of table tennis temporary solution.
Article code: 1430002



SPORTS FINISHING ACCESSORIES

WOOD VENTILATED SKIRTINGS



Specific wood varnished skirting with spaces made to allow cross ventilation of the wood flooring or sub-construction. For S'Match-it and Lumaflex ranges.

	Wood Ventilated Skirting	
	(standard)	(wide)
Oak varnished	1551067	1551068
Beech varnished	1551065	1551066
Maple varnished	1551069	1551070

Wood Ventilated Skirting (standard)

1 box of 5 units= 11.75 lm
Thickness: 22mm
Width: 65 mm
Length: 2350mm

Wood Ventilated Skirting (wide)

1 box of 4 units= 9.40 lm
Thickness: 27mm
Width: 84 mm
Length: 2350mm

TRAPDOORS

Trapdoors used to ensure the positioning of goals in sports halls. Filled with wood (S'Match-it range) or vinyl/linoleum (Lumaflex range) for perfect colour matching.

TRAPDOORS FOR WOOD RANGE



	Diameter 135mm (net opening 90mm)	Diameter 220mm (net opening 170mm)
Oak	1551028	1551029
Beech	1551030	1551031

TRAPDOORS FOR LUMAFLEX RANGE



	Diameter 135mm (net opening 90mm)	Diameter 220mm (net opening 170mm)
"bare" trapdoor to be filled with Linosport or Omnisports	1551034	1551035

HARD FLOORING FINISHING ACCESSORIES

TRANSITION SET FOR WOOD AND LUMAFLEX



Facilitates access to wood or combined sports systems (up to 40mm high). Made of exotic wood for extreme resistance.

40mm x 2700mm
5.4lm per bundle
Article code: 1551072

ADJUSTABLE RAMP



Aluminium adaptable ramp even for high thickness floorings. Conforms to accessibility standards and regulations.

140 x 960 mm
Order per unit
Max Height 100mm
Article code: 1551074



HARD FLOORING INSTALLATION ACCESSORIES

WOOD (TARGLUE / TARGUN)

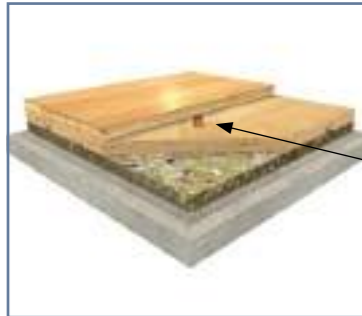

Targlue (PU mastic glue) and Targun have been specifically designed for the installation of Multiflex M. Applied with Targun, Targlue fixes the Tarflex subconstruction with the 14mm multi-layer.



Targlue
1 cardboard of 20 bags of 600ml each
1 cardboard = 200sqm
Article code: 1551006
Targun
order per unit
Article code: 1551007

LUMAFLEX GLUE

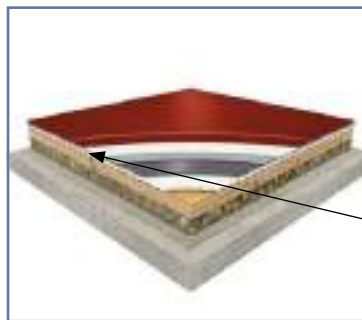

Lumaglue specially designed for Lumaflex sub-constructions.



Glue

LUMAGLUE
5kg bucket
Article code: 1551075

PROTECTIONS INSTALLATION ACCESSORIES

UNROLLER FOR TOUCHDOWN



(Special no stock)
Support article code: 1562001
Roller article code: 1562002

Unroller designed to facilitate the installation of Touchdown rolls. Made up of 2 supporting frameworks fitted with castors and one mandrel.



TROLLEY FOR PROTECTILES



Article code: 1568001

Trolley made of 4 articulated wheels with rubber strips and 2 brakes. Capacity: 100 ProtecTiles



ACCESSORIES

FOR ALL TYPES OF FLOORING

UNDERLAYERS FOR DAMP PROOF

TarkoDry Wall & Floor

- Watertight layer under ceramic tile (wetroom floor and wall) for a safe and long-lasting solution.
- Long-term waterproof warranty.
- Internally flexible homogeneous structure for easy installation and welding.

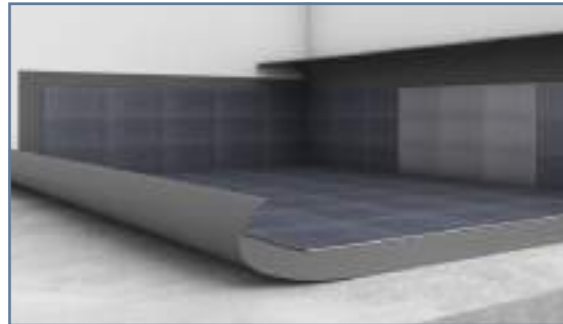

TarkoDry Wall

Material: homogeneous PVC underlayer
Total weight: 2.600g per m²
Total thickness: 1.5mm
Article code: 3137 028 - Grey

Compatible with: ceramic tiles

TarkoDry Floor

Material: homogeneous PVC underlayer
Total weight: 2.000g per m²
Total thickness: 1.2mm
Article code: 3138 027 - Grey

Compatible with: ceramic tiles

OVERLAYERS FOR FLOOR PROTECTION

Tarkoprotect 180

- High-performance protection and safety and perfect grip to flooring.
- Cost-effective solution by avoiding cleaning or replacement.
- Loose-lay installation to be removed easily and re-used.



Tarkoprotect 180

Material: tackified polyester veil reinforced with PE foil
Total weight: 180g per m²
Total thickness: 1.2mm
Article code: 24990 000 - White

Compatible with: all types of flooring

ADHESIVES SPRAY

TARKOSPRAY



Water based and easy to use flooring adhesive as a spray: 70% faster to apply, immediately ready for use and ideal for easy renovation, and environmental friendly.



Non-contractual illustration

Article codes:

France / Germany / The Netherlands 1460 001
United Kingdom / Poland

Italy / Spain / Sweden / Portugal 1460 005

1 box of 6 cans.
Min order: 20 boxes.

SPECIAL STRIPS STATIC CONTROL STRIPS FOR ROLLS

COPPER STRIPS



Copper thread to be installed in a grid-pattern underneath the flooring to facilitate static dissipative properties.

SAP code: 1256 727

