



LINOLEUM

xf²™

- Veneto xf²™ p. 412
- Style Elle xf²™ p. 424
- Style Emme xf²™ p. 426
- Etrusco xf²™ p. 428
- Veneto Sicuro xf²™ R10 p. 430

Essenza

- Veneto Essenza p. 436



OUR SELECTION OF ACCESSORIES FOR LINOLEUM



1

Set-in skirting

Preformed skirting made of linoleum, welded to the floor covering and glued to the wall to ensure easy to clean and hygienic result.

See p. 565 for detailed info



2

ProtectWALL

Protects the wall from impacts.

Cap

Provides a perfect finish and protects the edge of the wall covering.

See p. 582 for detailed info



3

Transition profile

TMT

Aluminium profile used at doorstep to join different floorings.

See p. 575 for detailed info



4

Set-on skirting

Tailor-made following the colour of the floor and resistant to shocks.

See p. 566 for detailed info



5

Floorcraft

We offer a dedicated Floorcraft Service to create unique flooring concepts through highlighting visual inlays, colourways, zoning and directional design.

See p. 590 for detailed info



6

Welding rod

Secures the junction between 2 rolls of flooring or wall and floor coverings.

See p. 562 for detailed info



7

Preformed Corner

Welded to the floor covering and glued to the wall. Shock resistant & watertight.

See p. 565 for detailed info

LINOLEUM xf²™ - COMPACT AND ACOUSTIC OFFER



THE **LINOVILLE** range offers a wide range of linoleum solutions, all 112 design colours available in compact & acoustic versions. The collection has been developed around the 4 fundamentals of environment, performance, design & well-being, for Education, Healthcare and Offices segments mainly.

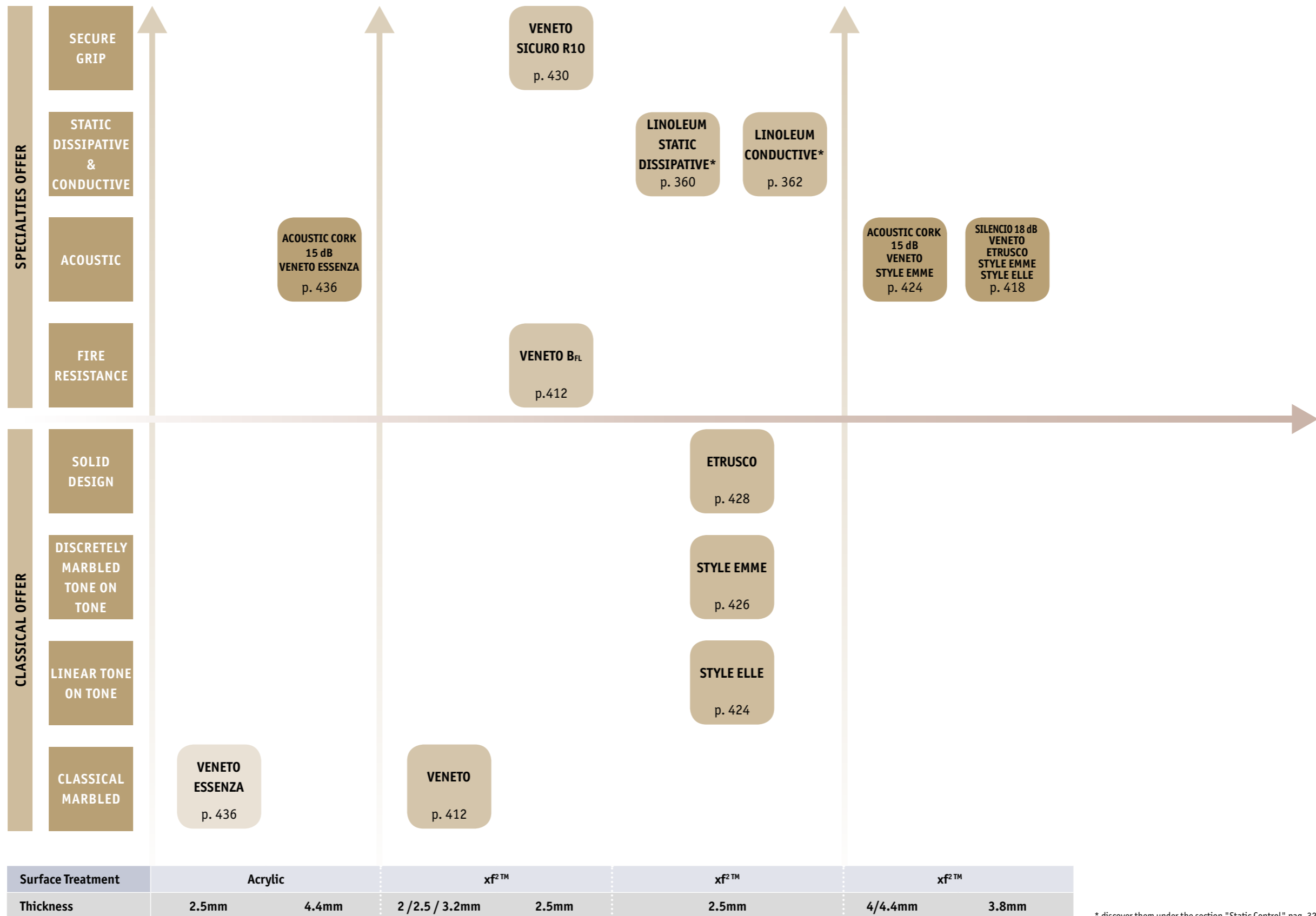

* discover them under the section "Static Control" pag. 320



LINOLEUM xf²™



A colourful collection with the new xf²™ surface treatment for truly distinctive decors in educational, healthcare and office environments
Healthcare and Offices

SENSORY BENEFITS

- Matt appearance for a natural look
- Vibrant, contemporary colour and designs that are easy to co-ordinate
- All 112 colours available in Compact and Acoustic Silencio 18dB
- Veneto and Style Emme designs available on request in Acoustic Cork 15dB option

FUNCTIONAL BENEFITS

- Save time and money on maintenance with the new xf²™ surface treatment: no polish, no stripping or polymer waxing over the lifetime of the product!

- Naturally bactericidal
- Tailored solutions for specific needs: Sicuro xf²™ R10, Veneto xf²™ B_{fl}, Linoleum xf²™ Static Dissipative and xf²™ Conductive (cf the "Static Control" section)

ENVIRONMENTAL BENEFITS

- Natural, recyclable flooring made from sustainable materials
- First cradle to cradle certified linoleum
- Contributes to better indoor air quality (FloorScore® certified)
- Simplified maintenance for a smaller carbon footprint

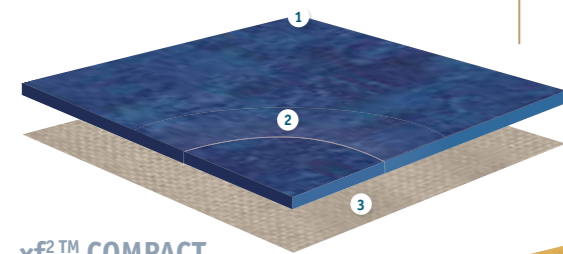

xf²™ COMPACT

- 1 xf²™ surface treatment
excellent performance and resistance to abrasion
- 2 Pure linoleum
stable design throughout product lifetime
- 3 Jute backing
natural, 100% bio-degradable

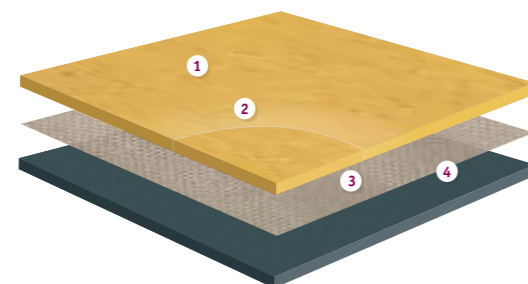

SILENCIO xf²™ / ACOUSTIC CORK xf²™

- 1 xf²™ surface treatment
excellent performance and resistance to abrasion
- 2 Pure linoleum
stable design throughout product lifetime
- 3 Jute backing
natural, 100% bio-degradable
- 4 Recycled polyurethane foam backing / cork backing
Silencio: 18dB impact sound reduction
Acoustic Cork: 15dB impact sound reduction

TECHNICAL DATA	STANDARDS	Veneto xf ² ™ 2mm	Veneto xf ² ™ Style Emme xf ² ™ Style Elle xf ² ™ Veneto xf ² ™ B _{fl} 2.5mm	Veneto xf ² ™ 3.2mm	Veneto Sicuro xf ² ™ R10 2.5mm	Veneto Silencio xf ² ™ 3.8mm	Veneto Acoustic Cork xf ² ™ 4mm	Veneto Acoustic Cork xf ² ™ Style Emme Acoustic Cork xf ² ™ 4.4mm	Etrusco xf ² ™ 2.5mm
Classification									
Classification	ISO 10874 domestic commercial light industrial	Classes: 23 32 41	Classes: 23 34 43	Classes: 23 34 43	Classes: 23 34 43	Classes: 23 33 41	Classes: 22 33 41	Classes: 23 34 42	Classes: 23 34 43
Characteristics									
Surface Treatment		xf ² ™	xf ² ™	xf ² ™	xf ² ™	xf ² ™	xf ² ™	xf ² ™	xf ² ™
Total thickness	ISO 24346	2.00mm	2.50mm	3.20mm	2.50mm	3.80mm	4.0mm	4.4mm	2.50mm
Total weight	ISO 23997	ca. 2 400g/m ²	ca. 3 000g/m ²	ca. 3 900g/m ²	ca. 3 000g/m ²	ca. 3 450g/m ²	ca. 4 100g/m ²	ca. 4 600g/m ²	ca. 3 000g/m ²
Technical performance									
Reaction to fire	EN 13501-1	C _i s1	C _i s1 (B _i s1 for Veneto xf ² ™ B _{fl})	C _i s1	C _i s1	C _i s1	C _i s1	C _i s1	C _i s1
Residual indentation	EN ISO 24343-1 Standard requirements Best measured value	≤ 0.15 mm ca. 0.07 mm	≤ 0.15 mm ca. 0.08 mm	≤ 0.15 mm ca. 0.10 mm	≤ 0.15 mm ca. 0.08 mm	≤ 0.30 mm ca. 0.20 mm	≤ 0.40 mm ca. 0.25 mm	≤ 0.40 mm ca. 0.25 mm	≤ 0.15 mm ca. 0.08 mm
Slip resistance	DIN 51130 EN 13893	R9 DS: ≥ 0.30	R9 DS: ≥ 0.30	R9 DS: ≥ 0.30	R10 DS: ≥ 0.30	R9 DS: ≥ 0.30	R9 DS: ≥ 0.30	R9 DS: ≥ 0.30	R9 DS: ≥ 0.30
Flexibility	ISO 24344 Method A	≤ 25mm	≤ 30mm	≤ 40mm	≤ 30mm	≤ 30mm	≤ 30mm	≤ 30mm	≤ 30mm
Castor chair	ISO 4918	Suitable for office chairs with castors type W (Norm EN 12529)							
Static electrical propensity	EN 1815	< 2kV	< 2kV	< 2kV	< 2kV	< 2kV	< 2kV	< 2kV	< 2kV
Chemical resistance	ISO 26987	Resistant to dilute acids, oils, fats, current solvents and alkalis							
Thermal resistance Underfloor heating	ISO 10456	0.012m ² K/W Suitable	0.015m ² K/W Suitable	0.019m ² K/W Suitable	0.015m ² K/W Suitable	0.040m ² K/W Suitable	0.042m ² K/W Suitable	0.045m ² K/W Suitable	0.015m ² K/W Suitable
Light fastness	EN ISO 105-B02 Method 3	≥ 6	≥ 6	≥ 6	≥ 6	≥ 6	≥ 6	≥ 6	≥ 6
Impact sound reduction	EN ISO 10140-3 EN ISO 717-2	5dB	6dB	8dB	6dB	18dB	15dB	15dB	6dB
Impact sound reduction with Elafono*		14dB	14dB	15dB	14dB	Not applicable			14dB
Acoustic improvement	NF 531-074	Class C (Ln,e,w<85dB)	Class C (Ln,e,w<85dB)	Class B (Ln,e,w<75dB)	Class C (Ln,e,w<85dB)	Class A (Ln,e,w<65dB)	Class B (Ln,e,w<75dB)		Class C (Ln,e,w<85dB)
Determination of antibacterial activity	ISO 22196	Naturally bactericidal							
Colours		20	72 (Veneto) 15 (Style Emme) 11 (Style Elle) 10 (Veneto B _{fl})	20	29	112	20 on request	on request: 72 (Veneto) - 30 (Essenza) - 15 (Style Emme)	14
Form of delivery	EN ISO 24341	< 32 x 2 m	< 32 x 2 m	< 32 x 2 m	< 32 x 2 m	< 30 x 2 m or < 30 x 1.95 m (subject to availability-please check upon order)			< 32 x 2 m

*Elafono: 2.0 mm traditional, 100% natural corkment underlay to be installed in combination with any compact Tarkett linoleum to get additional sound reduction (up to -15dB, depending on the product). Available in rolls ≤30 x 2m.

The above information is subject to modifications for the benefit of further improvement (02/2017). For more detailed technical information, please contact Tarkett.

Grands Classiques ♥, a selection of 20 timeless colours guaranteed to remain in production until 2033 in the following options:

- 2.0 - 2.5 - 3.2mm Veneto xf²™
- 2.5mm Veneto Sicuro xf²™ R10
- 2.5mm Veneto Essenza
- 3.8mm Veneto Silencio xf²™ 18dB
- 4.0mm Veneto Acoustic Cork xf²™ 15dB
- 4.4mm Veneto Acoustic Cork xf²™ 15dB
- 4.4mm Veneto Acoustic Cork Essenza 15dB

Find them on the following pages marked with ♥. Multicolor welding rods available.













All our linoleum ranges*
*Except Silencio, Linoleum SD xf² and Linoleum Conductive xf² ranges



VENETO xf²™



VENETO xf²™ - Aluminium

 <p>Slate</p> <ul style="list-style-type: none"> 2.0mm: 14871 674 2.5mm: 14872 674 2.5mm B_n: 14898 674 3.2mm: 14873 674 3.8mm: 14892 674 4.0mm: 14880 674 4.4mm: 14881 674 	 <p>Pebble</p> <ul style="list-style-type: none"> 2.0mm: 14871 604 2.5mm: 14872 604 3.2mm: 14873 604 3.8mm: 14892 604 4.0mm: 14880 604 4.4mm: 14881 604 	 <p>Stone</p> <ul style="list-style-type: none"> 2.5mm: 14872 692 3.8mm: 14892 692 4.4mm: 14881 692 	 <p>Aluminium</p> <ul style="list-style-type: none"> 2.0mm: 14871 672 2.5mm: 14872 672 3.2mm: 14873 672 3.8mm: 14892 672 4.0mm: 14880 672 4.4mm: 14881 672 	 <p>Platinum</p> <ul style="list-style-type: none"> 2.5mm: 14872 684 3.8mm: 14892 684 4.4mm: 14881 684
 <p>Travertine</p> <ul style="list-style-type: none"> 2.5mm: 14872 603 3.8mm: 14892 603 4.4mm: 14881 603 	 <p>Charcoal</p> <ul style="list-style-type: none"> 2.0mm: 14871 610 2.5mm: 14872 610 3.2mm: 14873 610 3.8mm: 14892 610 4.0mm: 14880 610 4.4mm: 14881 610 	 <p>Smoke</p> <ul style="list-style-type: none"> 2.0mm: 14871 608 2.5mm: 14872 608 3.2mm: 14873 608 3.8mm: 14892 608 4.0mm: 14880 608 4.4mm: 14881 608 	 <p>Concrete</p> <ul style="list-style-type: none"> 2.5mm: 14872 686 3.8mm: 14892 686 4.4mm: 14881 686 	 <p>Pewter</p> <ul style="list-style-type: none"> 2.5mm: 14872 685 3.8mm: 14892 685 4.4mm: 14881 685



Grands Classiques

TECHNICAL DATA	STANDARDS	Veneto xf ² ™ 2mm	Veneto xf ² ™ B _n 2.5mm	Veneto xf ² ™ 3.2mm	Veneto Silencio xf ² ™ 3.8mm	Veneto Acoustic Cork xf ² ™ 4mm	Veneto Acoustic Cork xf ² ™ 4.4mm
Classification							
Classification	ISO 10874 domestic commercial light industrial	Classes: 23 32 41	Classes: 23 34 43	Classes: 23 34 43	Classes: 23 33 41	Classes: 22 33 41	Classes: 23 34 42
Characteristics							
Surface Treatment		xf ² ™	xf ² ™	xf ² ™	xf ² ™	xf ² ™	xf ² ™
Total thickness	ISO 24346	2.00mm	2.50mm	3.20mm	3.80mm	4.0mm	4.4mm
Total weight	ISO 23997	ca. 2400g/m ²	ca. 3000g/m ²	ca. 3900g/m ²	ca. 4450g/m ²	ca. 4100g/m ²	ca. 4600g/m ²
Technical performance							
Reaction to fire	EN 13501-1	C _n s1	C _n s1 (B _n s1 for Veneto xf ² ™ B _n)	C _n s1	C _n s1	C _n s1	C _n s1
Residual indentation	EN ISO 24343-1 Standard requirements Best measured value	≤ 0.15 mm ca. 0.07 mm	≤ 0.15 mm ca. 0.08 mm	≤ 0.15 mm ca. 0.10 mm	≤ 0.15 mm ca. 0.08 mm	≤ 0.30 mm ca. 0.20 mm	≤ 0.40 mm ca. 0.25 mm
Slip resistance	DIN 51130 EN 13893	R9 DS: ≥ 0.30	R9 DS: ≥ 0.30	R9 DS: ≥ 0.30	R9 DS: ≥ 0.30	R9 DS: ≥ 0.30	R9 DS: ≥ 0.30
Flexibility	ISO 24344 Method A	≤ 25mm	≤ 30mm	≤ 40mm	≤ 30mm	≤ 30mm	≤ 30mm
Castor chair	ISO 4918	Suitable for office chairs with castors type W (Norm EN 12529)					
Static electrical propensity	EN 1815	< 2kV	< 2kV	< 2kV	< 2kV	< 2kV	< 2kV
Chemical resistance	ISO 26987	Resistant to dilute acids, oils, fats, current solvents and alkalis					
Thermal resistance Underfloor heating	ISO 10456	0.012m ² K/W Suitable	0.015m ² K/W Suitable	0.019m ² K/W Suitable	0.040m ² K/W Suitable	0.042m ² K/W Suitable	0.045m ² K/W Suitable
Light fastness	EN ISO 105-B02 Method 3	≥ 6	≥ 6	≥ 6	≥ 6	≥ 6	≥ 6
Impact sound reduction	EN ISO 10140-3	5dB	6dB	8dB	18dB	15dB	15dB
Impact sound reduction with Elafono*	EN ISO 717-2	14dB	14dB	15dB	Not applicable		
Acoustic improvement	NF S31-074	Class C (Ln,e,w < 85dB)	Class C (Ln,e,w < 85dB)	Class B (Ln,e,w < 75dB)	Class A (Ln,e,w < 65dB)	Class B (Ln,e,w < 75dB)	
Determination of antibacterial activity	ISO 22196	Naturally bactericidal					

*Elafono: 2.0 mm traditional, 100% natural cork underlay to be installed in combination with any compact Tarkett linoleum to get additional sound reduction (up to -15dB, depending on the product). Available in rolls ≤30 x 2m. The above information is subject to modifications for the benefit of further improvement (02/2017). For more detailed technical information, please contact Tarkett.

VENETO xf²™ Classical marbled Greys

Main Product Features

- Superior xf²™ protection for extreme mechanical and chemical toughness
- The classical marbled linoleum solution with soft or intense pattern variations for a timeless effect
- All 72 colours also available on request in Silencio xf²™ 18dB and in Acoustic Cork version

Surface Treatment



Sustainability Tag

Veneto xf²™

- 94% Natural Renewable
- 76% Recyclable Recycled content
- 100% Recyclable Recycled content
- 36% Recyclable Recycled content
- PHthalate FREE
- ≤ 100 µg/m³ Better Indoor Air Quality
- *TVOC AT 28 DAYS



Veneto Silencio xf²™









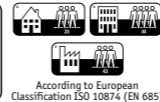

- 83% Natural Renewable
- 65% Recyclable Recycled content
- 100% Recyclable Recycled content
- 40% Recyclable Recycled content
- PHthalate FREE
- ≤ 100 µg/m³ Better Indoor Air Quality
- *TVOC AT 28 DAYS

Veneto Acoustic Cork xf²™

- 93% Natural Renewable
- 77% Recyclable Recycled content
- 100% Recyclable Recycled content
- 33% Recyclable Recycled content
- PHthalate FREE
- ≤ 100 µg/m³ Better Indoor Air Quality
- *TVOC AT 28 DAYS

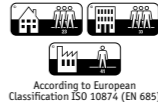

General Information

 <p>Veneto xf²™ 2mm 0200-0010-DoP-2013-07 https://professionals.tarkett.com Manufactured by: Tarkett SpA 05035 Narni, ITALY EN 14041:2004</p>	 <p>According to European Classification ISO 10874 (EN 685)</p>
 <p>Veneto xf²™ 2.5mm 0200-0001-DoP-2013-07 https://professionals.tarkett.com Manufactured by: Tarkett SpA 05035 Narni, ITALY EN 14041:2004</p>	 <p>According to European Classification ISO 10874 (EN 685)</p>
 <p>Veneto xf²™ 3.2mm 0200-0012-DoP-2013-07 https://professionals.tarkett.com Manufactured by: Tarkett SpA 05035 Narni, ITALY EN 14041:2004</p>	 <p>According to European Classification ISO 10874 (EN 685)</p>
 <p>Acoustic Cork xf²™ 4mm 0200-0024-DoP-2013-07 https://professionals.tarkett.com Manufactured by: Tarkett SpA 05035 Narni, ITALY EN 14041:2004</p>	 <p>According to European Classification ISO 10874 (EN 685)</p>
 <p>Veneto Silencio xf²™ 3.8mm 0200-0014-DoP-2013-07 https://professionals.tarkett.com Manufactured by: Tarkett SpA 05035 Narni, ITALY EN 14041:2004</p>	 <p>According to European Classification ISO 10874 (EN 685)</p>
 <p>Veneto B_n 2.5mm 0200-0014-DoP-2013-07 https://professionals.tarkett.com Manufactured by: Tarkett SpA 05035 Narni, ITALY EN 14041:2004</p>	 <p>According to European Classification ISO 10874 (EN 685)</p>

Logistics Information

- (2.5mm) Available in rolls Rolls length: ≤30lm
- Silencio (3.8mm) Rolls length: ≤27lm
- Acoustic Cork (4.0mm) Rolls length: ≤27lm
- Acoustic Cork (4.4mm) Rolls length: ≤27lm

Laying direction:



VENETO xf²™



VENETO xf²™ - Grey



Grey	Graphite	Storm	Steel	Zinc
<ul style="list-style-type: none"> 2.0mm: 14871 793 2.5mm: 14872 793 2.5mm B_n: 14898 793 3.2mm: 14873 793 3.8mm: 14892 793 4.0mm: 14880 793 4.4mm: 14881 793 	<ul style="list-style-type: none"> 2.0mm: 14871 906 2.5mm: 14872 906 3.2mm: 14873 906 3.8mm: 14892 906 4.0mm: 14880 906 4.4mm: 14881 906 	<ul style="list-style-type: none"> 2.0mm: 14871 702 2.5mm: 14872 702 3.2mm: 14873 702 3.8mm: 14892 702 4.0mm: 14880 702 4.4mm: 14881 702 	<ul style="list-style-type: none"> 2.0mm: 14871 673 2.5mm: 14872 673 2.5mm B_n: 14898 673 3.8mm: 14892 673 4.0mm: 14880 673 4.4mm: 14881 673 	<ul style="list-style-type: none"> 2.0mm: 14871 671 2.5mm: 14872 671 3.2mm: 14873 671 3.8mm: 14892 671 4.0mm: 14880 671 4.4mm: 14881 671
Ivory	Ash	Fog		
<ul style="list-style-type: none"> 2.5mm: 14872 601 3.8mm: 14892 601 4.4mm: 14881 601 	<ul style="list-style-type: none"> 2.5mm: 14872 704 2.5mm B_n: 14898 704 3.8mm: 14892 704 4.4mm: 14881 704 	<ul style="list-style-type: none"> 2.5mm: 14872 703 3.8mm: 14892 703 4.4mm: 14881 703 		

TECHNICAL DATA	STANDARDS	Veneto xf ² ™ 2mm	Veneto xf ² ™ 2.5mm B _n	Veneto xf ² ™ 3.2mm	Veneto Silencio xf ² ™ 3.8mm	Veneto Acoustic Cork xf ² ™ 4mm	Veneto Acoustic Cork xf ² ™ 4.4mm
Classification							
Classification	ISO 10874 domestic commercial light industrial	Classes: 23 32 41	Classes: 23 34 43	Classes: 23 34 43	Classes: 23 33 41	Classes: 22 33 41	Classes: 23 34 42
Characteristics							
Surface Treatment		xf ² ™	xf ² ™	xf ² ™	xf ² ™	xf ² ™	xf ² ™
Total thickness	ISO 24346	2.00mm	2.50mm	3.20mm	3.80mm	4.0mm	4.4mm
Total weight	ISO 23997	ca. 2400g/m ²	ca. 3000g/m ²	ca. 3900g/m ²	ca. 4450g/m ²	ca. 4100g/m ²	ca. 4600g/m ²
Technical performance							
Reaction to fire	EN 13501-1	C _n s1	C _n s1 (B _n s1 for Veneto xf ² ™ B _n)	C _n s1	C _n s1	C _n s1	C _n s1
Residual indentation	EN ISO 24343-1 Standard requirements Best measured value	≤ 0.15 mm ca. 0.07 mm	≤ 0.15 mm ca. 0.08 mm	≤ 0.15 mm ca. 0.10 mm	≤ 0.15 mm ca. 0.08 mm	≤ 0.30 mm ca. 0.20 mm	≤ 0.40 mm ca. 0.25 mm
Slip resistance	DIN 51130 EN 13893	R9 DS: ≥ 0.30	R9 DS: ≥ 0.30	R9 DS: ≥ 0.30	R9 DS: ≥ 0.30	R9 DS: ≥ 0.30	R9 DS: ≥ 0.30
Flexibility	ISO 24344 Method A	≤ 25mm	≤ 30mm	≤ 40mm	≤ 30mm	≤ 30mm	≤ 30mm
Castor chair	ISO 4918	Suitable for office chairs with castors type W (Norm EN 12529)					
Static electrical propensity	EN 1815	< 2kV	< 2kV	< 2kV	< 2kV	< 2kV	< 2kV
Chemical resistance	ISO 26987	Resistant to dilute acids, oils, fats, current solvents and alkalis					
Thermal resistance Underfloor heating	ISO 10456	0.012m ² K/W Suitable	0.015m ² K/W Suitable	0.019m ² K/W Suitable	0.040m ² K/W Suitable	0.042m ² K/W Suitable	0.045m ² K/W Suitable
Light fastness	EN ISO 105-B02 Method 3	≥ 6	≥ 6	≥ 6	≥ 6	≥ 6	≥ 6
Impact sound reduction	EN ISO 10140-3	5dB	6dB	8dB	18dB	15dB	15dB
Impact sound reduction with Elafono*	EN ISO 717-2	14dB	14dB	15dB	Not applicable		
Acoustic improvement	NF S31-074	Class C (Ln,e,w < 85dB)	Class C (Ln,e,w < 85dB)	Class B (Ln,e,w < 75dB)	Class A (Ln,e,w < 65dB)	Class B (Ln,e,w < 75dB)	
Determination of antibacterial activity	ISO 22196	Naturally bactericidal					

*Elafono: 2.0 mm traditional, 100% natural cork underlay to be installed in combination with any compact Tarkett linoleum to get additional sound reduction (up to -15dB, depending on the product). Available in rolls ≤30 x 2m. The above information is subject to modifications for the benefit of further improvement (02/2017). For more detailed technical information, please contact Tarkett.

General Information

<p>Veneto xf²™ 2mm 0200-0010-DoP-2013-07 https://professionals.tarkett.com Manufactured by: Tarkett SpA 05035 Narni, ITALY</p>	<p>According to European Classification ISO 10874 (EN 685)</p>
<p>Veneto xf²™ 2.5mm 0200-0001-DoP-2013-07 https://professionals.tarkett.com Manufactured by: Tarkett SpA 05035 Narni, ITALY</p>	<p>According to European Classification ISO 10874 (EN 685)</p>
<p>Veneto xf²™ 3.2mm 0200-0012-DoP-2013-07 https://professionals.tarkett.com Manufactured by: Tarkett SpA 05035 Narni, ITALY</p>	<p>According to European Classification ISO 10874 (EN 685)</p>
<p>Veneto Silencio xf²™ 3.8mm 0200-0027-DoP-2013-07 https://professionals.tarkett.com Manufactured by: Tarkett SpA 05035 Narni, ITALY</p>	<p>According to European Classification ISO 10874 (EN 685)</p>
<p>Veneto B_n 2.5mm 0200-0014-DoP-2013-07 https://professionals.tarkett.com Manufactured by: Tarkett SpA 05035 Narni, ITALY</p>	<p>According to European Classification ISO 10874 (EN 685)</p>
<p>Acoustic Cork xf²™ 4mm 0200-0024-DoP-2013-07 https://professionals.tarkett.com Manufactured by: Tarkett SpA 05035 Narni, ITALY</p>	<p>According to European Classification ISO 10874 (EN 685)</p>
<p>Acoustic Cork xf²™ 4.4mm 0200-0025-DoP-2013-07 https://professionals.tarkett.com Manufactured by: Tarkett SpA 05035 Narni, ITALY</p>	<p>According to European Classification ISO 10874 (EN 685)</p>

VENETO xf²™ Classical marbled Greys

Main Product Features

- Superior xf²™ protection for extreme mechanical and chemical toughness
- The classical marbled linoleum solution with soft or intense pattern variations for a timeless effect
- All 72 colours also available on request in Silencio xf²™ 18dB and in Acoustic Cork version

Surface Treatment



Sustainability Tag

<p>Veneto xf²™</p> <ul style="list-style-type: none"> 94% Natural Renewable 76% Recyclable Recycled content PHTHALATE FREE <100 µg/m³ Better Indoor Air Quality <p>Restart Ready</p>	<p>Veneto Silencio xf²™</p> <ul style="list-style-type: none"> 83% Natural Renewable 65% Recyclable Recycled content PHTHALATE FREE <100 µg/m³ Better Indoor Air Quality <p>Restart Ready</p>	<p>Veneto Acoustic Cork xf²™</p> <ul style="list-style-type: none"> 93% Natural Renewable 77% Recyclable Recycled content PHTHALATE FREE <100 µg/m³ Better Indoor Air Quality <p>Restart Ready</p>
--	---	--

Logistics Information

	(2.5mm)	Available in rolls
		Rolls length: ≤301m
	Silencio (3.8mm)	Rolls length: ≤271m
	Acoustic Cork (4.0mm)	Rolls length: ≤271m
	Acoustic Cork (4.4mm)	Rolls length: ≤271m
Laying direction:		

VENETO xf²™



VENETO xf²™ - 100% Linen

Camel	Sisal	Ecru	White	Silk
<ul style="list-style-type: none"> 2.0mm: 14871 616 2.5mm: 14872 616 3.2mm: 14873 616 3.8mm: 14892 616 4.0mm: 14880 616 4.4mm: 14881 616 	<ul style="list-style-type: none"> 2.0mm: 14871 611 2.5mm: 14872 611 3.2mm: 14873 611 3.8mm: 14892 611 4.0mm: 14880 611 4.4mm: 14881 611 	<ul style="list-style-type: none"> 2.0mm: 14871 711 2.5mm: 14872 711 2.5mmB_n: 14898 711 3.2mm: 14873 711 3.8mm: 14892 711 4.0mm: 14880 711 4.4mm: 14881 711 	<ul style="list-style-type: none"> 2.5mm: 14872 700 3.8mm: 14892 700 4.4mm: 14881 700 	<ul style="list-style-type: none"> 2.5mm: 14872 625 3.8mm: 14892 625 4.4mm: 14881 625
100% linen	Cork	Azurite	Burlap	Taupe Dark
<ul style="list-style-type: none"> 2.5mm: 14872 400 3.8mm: 14892 400 4.4mm: 14881 400 	<ul style="list-style-type: none"> 2.0mm: 14871 679 2.5mm: 14872 679 3.2mm: 14873 679 3.8mm: 14892 679 4.0mm: 14880 679 4.4mm: 14881 679 	<ul style="list-style-type: none"> 2.5mm: 14872 624 3.8mm: 14892 624 4.4mm: 14881 624 	<ul style="list-style-type: none"> 2.5mm: 14872 911 3.8mm: 14892 911 4.4mm: 14881 911 	<ul style="list-style-type: none"> 2.5mm: 14872 714 3.8mm: 14892 714 4.4mm: 14881 714

Grands Classiques

TECHNICAL DATA	STANDARDS	Veneto xf ² ™ 2mm	Veneto xf ² ™ Veneto xf ² ™ B _n 2.5mm	Veneto xf ² ™ 3.2mm	Veneto Silencio xf ² ™ 3.8mm	Veneto Acoustic Cork xf ² ™ 4mm	Veneto Acoustic Cork xf ² ™ 4.4mm
Classification							
Classification	ISO 10874 domestic commercial light industrial	Classes: 23 32 41	Classes: 23 34 43	Classes: 23 34 43	Classes: 23 33 41	Classes: 22 33 41	Classes: 23 34 42
Characteristics							
Surface Treatment		xf ² ™	xf ² ™	xf ² ™	xf ² ™	xf ² ™	xf ² ™
Total thickness	ISO 24346	2.00mm	2.50mm	3.20mm	3.80mm	4.0mm	4.4mm
Total weight	ISO 23997	ca. 2400g/m ²	ca. 3000g/m ²	ca. 3900g/m ²	ca. 3450g/m ²	ca. 4100g/m ²	ca. 4600g/m ²
Technical performance							
Reaction to fire	EN 13501-1	C _n s1	C _n s1 (B _n s1 for Veneto xf ² ™ B _n)	C _n s1	C _n s1	C _n s1	C _n s1
Residual indentation	EN ISO 24343-1 Standard requirements Best measured value	≤ 0.15 mm ca. 0.07 mm	≤ 0.15 mm ca. 0.08 mm	≤ 0.15 mm ca. 0.10 mm	≤ 0.15 mm ca. 0.08 mm	≤ 0.30 mm ca. 0.20 mm	≤ 0.40 mm ca. 0.25 mm
Slip resistance	DIN 51130 EN 13893	R9 DS: ≥ 0.30	R9 DS: ≥ 0.30	R9 DS: ≥ 0.30	R9 DS: ≥ 0.30	R9 DS: ≥ 0.30	R9 DS: ≥ 0.30
Flexibility	ISO 24344 Method A	≤ 25mm	≤ 30mm	≤ 40mm	≤ 30mm	≤ 30mm	≤ 30mm
Castor chair	ISO 4918	Suitable for office chairs with castors type W (Norm EN 12529)					
Static electrical propensity	EN 1815	< 2kV	< 2kV	< 2kV	< 2kV	< 2kV	< 2kV
Chemical resistance	ISO 26987	Resistant to dilute acids, oils, fats, current solvents and alkalis					
Thermal resistance Underfloor heating	ISO 10456	0.012m ² K/W Suitable	0.015m ² K/W Suitable	0.019m ² K/W Suitable	0.040m ² K/W Suitable	0.042m ² K/W Suitable	0.045m ² K/W Suitable
Light fastness	EN ISO 105-B02 Method 3	≥ 6	≥ 6	≥ 6	≥ 6	≥ 6	≥ 6
Impact sound reduction	EN ISO 10140-3	5dB	6dB	8dB	18dB	15dB	15dB
Impact sound reduction with Elafono*	EN ISO 717-2	14dB	14dB	15dB	Not applicable		
Acoustic improvement	NF S31-074	Class C (Ln,e,w < 85dB)	Class C (Ln,e,w < 85dB)	Class B (Ln,e,w < 75dB)	Class A (Ln,e,w < 65dB)	Class B (Ln,e,w < 75dB)	
Determination of antibacterial activity	ISO 22196	Naturally bactericidal					

*Elafono: 2.0 mm traditional, 100% natural cork underlay to be installed in combination with any compact Tarkett linoleum to get additional sound reduction (up to -15dB, depending on the product). Available in rolls ≤30 x 2m. The above information is subject to modifications for the benefit of further improvement (02/2017). For more detailed technical information, please contact Tarkett.

General Information

	Veneto xf²™ 2mm 0200-0010-DoP-2013-07 https://professionals.tarkett.com Manufactured by: Tarkett SpA 05035 Narni, ITALY EN 14041:2004						
	Veneto xf²™ 2.5mm 0200-0001-DoP-2013-07 https://professionals.tarkett.com Manufactured by: Tarkett SpA 05035 Narni, ITALY EN 14041:2004						
	Veneto xf²™ 3.2mm 0200-0012-DoP-2013-07 https://professionals.tarkett.com Manufactured by: Tarkett SpA 05035 Narni, ITALY EN 14041:2004						
	Veneto Silencio xf²™ 3.8mm 0200-0027-DoP-2013-07 https://professionals.tarkett.com Manufactured by: Tarkett SpA 05035 Narni, ITALY EN 14041:2004						
	Veneto B_n 2.5mm 0200-0014-DoP-2013-07 https://professionals.tarkett.com Manufactured by: Tarkett SpA 05035 Narni, ITALY EN 14041:2004						
	Acoustic Cork xf²™ 4mm 0200-0024-DoP-2013-07 https://professionals.tarkett.com Manufactured by: Tarkett SpA 05035 Narni, ITALY EN 14041:2004						
	Acoustic Cork xf²™ 4.4mm 0200-0025-DoP-2013-07 https://professionals.tarkett.com Manufactured by: Tarkett SpA 05035 Narni, ITALY EN 14041:2004						

VENETO xf²™ Classical marbled Beiges

Main Product Features

- Superior xf²™ protection for extreme mechanical and chemical toughness
- The classical marbled linoleum solution with soft or intense pattern variations for a timeless effect
- All 72 colours also available on request in Silencio xf²™ 18dB and in Acoustic Cork version

Surface Treatment



Sustainability Tag

Veneto xf²™

94% 76%	100% 36%	PHthalate FREE	≤100µg/m ³ Better Indoor Air Quality
Natural Renewable	Recyclable Recycled content		*TVOC AT 28 DAYS



Veneto Silencio xf²™

83% 65%	100% 40%	PHthalate FREE	≤100µg/m ³ Better Indoor Air Quality
Natural Renewable	Recyclable Recycled content		*TVOC AT 28 DAYS

Veneto Acoustic Cork xf²™

93% 77%	100% 33%	PHthalate FREE	≤100µg/m ³ Better Indoor Air Quality
Natural Renewable	Recyclable Recycled content		*TVOC AT 28 DAYS



Logistics Information

- (2.5mm) Available in rolls
Rolls length: ≤30m
- Silencio (3.8mm) Rolls length: ≤27m
- Acoustic Cork (4.0mm) Rolls length: ≤27m
- Acoustic Cork (4.4mm) Rolls length: ≤27m

Laying direction:



VENETO xf²™



VENETO xf²™ - Tiger Eye

Tiger Eye	Sandstorm	Durango	Neutral	Sand
<ul style="list-style-type: none"> 2.5mm: 14872 524 2.5mm B_n: 14898 524 3.8mm: 14892 524 4.4mm: 14881 524 	<ul style="list-style-type: none"> 2.5mm: 14872 712 3.8mm: 14892 712 4.4mm: 14881 712 	<ul style="list-style-type: none"> 2.5mm: 14872 121 3.8mm: 14892 121 4.4mm: 14881 121 	<ul style="list-style-type: none"> 2.0mm: 14871 710 2.5mm: 14872 710 3.2mm: 14873 710 3.8mm: 14892 710 4.0mm: 14880 710 4.4mm: 14881 710 	<ul style="list-style-type: none"> 2.5mm: 14872 622 3.8mm: 14892 622 4.4mm: 14881 622
Fossil	Citrine	Chocolate	Almond	
<ul style="list-style-type: none"> 2.5mm: 14872 502 3.8mm: 14892 502 4.4mm: 14881 502 	<ul style="list-style-type: none"> 2.5mm: 14872 631 3.8mm: 14892 631 4.4mm: 14881 631 	<ul style="list-style-type: none"> 2.5mm: 14872 632 3.8mm: 14892 632 4.4mm: 14881 632 	<ul style="list-style-type: none"> 2.5mm: 14872 637 3.8mm: 14892 637 4.4mm: 14881 637 	

▼ Grands Classiques

TECHNICAL DATA	STANDARDS	Veneto xf ² ™ 2mm	Veneto xf ² ™ Veneto xf ² ™ B _n 2.5mm	Veneto xf ² ™ 3.2mm	Veneto Silencio xf ² ™ 3.8mm	Veneto Acoustic Cork xf ² ™ 4mm	Veneto Acoustic Cork xf ² ™ 4.4mm
Classification							
Classification	ISO 10874 domestic commercial light industrial	Classes: 23 32 41	Classes: 23 34 43	Classes: 23 34 43	Classes: 23 33 41	Classes: 22 33 41	Classes: 23 34 42
Characteristics							
Surface Treatment		xf ² ™	xf ² ™	xf ² ™	xf ² ™	xf ² ™	xf ² ™
Total thickness	ISO 24346	2.00mm	2.50mm	3.20mm	3.80mm	4.0mm	4.4mm
Total weight	ISO 23997	ca. 2.400g/m ²	ca. 3.000g/m ²	ca. 3.900g/m ²	ca. 3.450g/m ²	ca. 4.100g/m ²	ca. 4.600g/m ²
Technical performance							
Reaction to fire	EN 13501-1	C _n s1	C _n s1 (B _n s1 for Veneto xf ² ™ B _n)	C _n s1	C _n s1	C _n s1	C _n s1
Residual indentation	EN ISO 24343-1 Standard requirements Best measured value	≤ 0.15 mm ca. 0.07 mm	≤ 0.15 mm ca. 0.08 mm	≤ 0.15 mm ca. 0.10 mm	≤ 0.15 mm ca. 0.08 mm	≤ 0.30 mm ca. 0.20 mm	≤ 0.40 mm ca. 0.25 mm
Slip resistance	DIN 51130 EN 13893	R9 DS: ≥ 0.30	R9 DS: ≥ 0.30	R9 DS: ≥ 0.30	R9 DS: ≥ 0.30	R9 DS: ≥ 0.30	R9 DS: ≥ 0.30
Flexibility	ISO 24344 Method A	≤ 25mm	≤ 30mm	≤ 40mm	≤ 30mm	≤ 30mm	≤ 30mm
Castor chair	ISO 4918	Suitable for office chairs with castors type W (Norm EN 12529)					
Static electrical propensity	EN 1815	< 2kV	< 2kV	< 2kV	< 2kV	< 2kV	< 2kV
Chemical resistance	ISO 26987	Resistant to dilute acids, oils, fats, current solvents and alkalis					
Thermal resistance Underfloor heating	ISO 10456	0.012m ² K/W Suitable	0.015m ² K/W Suitable	0.019m ² K/W Suitable	0.040m ² K/W Suitable	0.042m ² K/W Suitable	0.045m ² K/W Suitable
Light fastness	EN ISO 105-B02 Method 3	≥ 6	≥ 6	≥ 6	≥ 6	≥ 6	≥ 6
Impact sound reduction	EN ISO 10140-3	5dB	6dB	8dB	18dB	15dB	15dB
Impact sound reduction with Elafono*	EN ISO 717-2	14dB	14dB	15dB	Not applicable		
Acoustic improvement	NF S31-074	Class C (Ln,e,w < 85dB)	Class C (Ln,e,w < 85dB)	Class B (Ln,e,w < 75dB)	Class A (Ln,e,w < 65dB)	Class B (Ln,e,w < 75dB)	
Determination of antibacterial activity	ISO 22196	Naturally bactericidal					

*Elafono: 2.0 mm traditional, 100% natural cork underlay to be installed in combination with any compact Tarkett linoleum to get additional sound reduction (up to -15dB, depending on the product). Available in rolls ≤30 x 2m. The above information is subject to modifications for the benefit of further improvement (02/2017). For more detailed technical information, please contact Tarkett.

VENETO xf²™ Classical marbled Beiges

Main Product Features

- Superior xf²™ protection for extreme mechanical and chemical toughness
- The classical marbled linoleum solution with soft or intense pattern variations for a timeless effect
- All 72 colours also available on request in Silencio xf²™ 18dB and in Acoustic Cork version

Surface Treatment



Sustainability Tag

Veneto xf²™

94% Natural Renewable	76% Recyclable Recycled content	100% Recyclable Recycled content	PHthalate FREE	≤ 100µg/m ³ Better Indoor Air Quality
-----------------------	---------------------------------	----------------------------------	----------------	--

Restart Ready

Veneto Silencio xf²™

83% Natural Renewable	65% Recyclable Recycled content	100% Recyclable Recycled content	PHthalate FREE	≤ 100µg/m ³ Better Indoor Air Quality
-----------------------	---------------------------------	----------------------------------	----------------	--

Restart Ready

Veneto Acoustic Cork xf²™

93% Natural Renewable	77% Recyclable Recycled content	100% Recyclable Recycled content	PHthalate FREE	≤ 100µg/m ³ Better Indoor Air Quality
-----------------------	---------------------------------	----------------------------------	----------------	--

Restart Ready

General Information

	Veneto xf²™ 2mm 0200-0010-DoP-2013-07 https://professionals.tarkett.com Manufactured by: Tarkett SpA 05035 Narni, ITALY			
	Veneto xf²™ 2.5mm 0200-0001-DoP-2013-07 https://professionals.tarkett.com Manufactured by: Tarkett SpA 05035 Narni, ITALY			
	Veneto Silencio xf²™ 3.8mm 0200-0027-DoP-2013-07 https://professionals.tarkett.com Manufactured by: Tarkett SpA 05035 Narni, ITALY			
	Veneto xf²™ 3.2mm 0200-0012-DoP-2013-07 https://professionals.tarkett.com Manufactured by: Tarkett SpA 05035 Narni, ITALY			
	Veneto B_n 2.5mm 0200-0014-DoP-2013-07 https://professionals.tarkett.com Manufactured by: Tarkett SpA 05035 Narni, ITALY			
	Acoustic Cork xf²™ 4mm 0200-0024-DoP-2013-07 https://professionals.tarkett.com Manufactured by: Tarkett SpA 05035 Narni, ITALY			
	Acoustic Cork xf²™ 4.4mm 0200-0025-DoP-2013-07 https://professionals.tarkett.com Manufactured by: Tarkett SpA 05035 Narni, ITALY			

Logistics Information

- (2.5mm) Available in rolls Rolls length: ≤30lm
- Silencio (3.8mm) Rolls length: ≤27lm
- Acoustic Cork (4.0mm) Rolls length: ≤27lm
- Acoustic Cork (4.4mm) Rolls length: ≤27lm

Laying direction:

















VENETO xf²™



VENETO xf²™ - Deep Blue





 Deep Blue	 Ocean	 Sapphire	 Hyacinth	 Blue Purple
2.5mm: 14872 767 3.8mm: 14892 767 4.4mm: 14881 767	2.5mm: 14872 665 3.8mm: 14892 665 4.4mm: 14881 665	2.5mm: 14872 760 3.8mm: 14892 760 4.4mm: 14881 760	2.5mm: 14872 764 3.8mm: 14892 764 4.4mm: 14881 764	2.5mm: 14872 762 3.8mm: 14892 762 4.4mm: 14881 762
 Lavender	 Periwinkle	 Begonia	 Navy	 Horizon
2.5mm: 14872 670 3.8mm: 14892 670 4.4mm: 14881 670	2.5mm: 14872 761 3.8mm: 14892 761 4.4mm: 14881 761	2.5mm: 14872 742 3.8mm: 14892 742 4.4mm: 14881 742	2.5mm: 14872 688 2.5mm B _n : 14898 688 3.8mm: 14892 688 4.4mm: 14881 688	2.0mm: 14871 650 2.5mm: 14872 650 3.2mm: 14873 650 3.8mm: 14892 650 4.0mm: 14880 650 4.4mm: 14881 650
 Mint	 Granata	 Absinthe	 Willow Green	 Apple Green
2.5mm: 14872 651 3.8mm: 14892 651 4.4mm: 14881 651	2.5mm: 14872 741 3.8mm: 14892 741 4.4mm: 14881 741	2.5mm: 14872 695 2.5mm B _n : 14898 695 3.8mm: 14892 695 4.4mm: 14881 695	2.5mm: 14872 756 3.8mm: 14892 756 4.4mm: 14881 756	2.5mm: 14872 754 3.8mm: 14892 754 4.4mm: 14881 754

♥ Grands Classiques







TECHNICAL DATA	STANDARDS	Veneto xf ² ™ 2mm	Veneto xf ² ™ Veneto xf ² ™ B _n 2.5mm	Veneto xf ² ™ 3.2mm	Veneto Silencio xf ² ™ 3.8mm	Veneto Acoustic Cork xf ² ™ 4mm	Veneto Acoustic Cork xf ² ™ 4.4mm
Classification							
Classification	ISO 10874 domestic commercial light industrial	Classes: 23 32 41	Classes: 23 34 43	Classes: 23 34 43	Classes: 23 33 41	Classes: 22 33 41	Classes: 23 34 42
Characteristics							
Surface Treatment		xf ² ™	xf ² ™	xf ² ™	xf ² ™	xf ² ™	xf ² ™
Total thickness	ISO 24346	2.00mm	2.50mm	3.20mm	3.80mm	4.0mm	4.4mm
Total weight	ISO 23997	ca. 2400g/m ²	ca. 3 000g/m ²	ca. 3 900g/m ²	ca. 3 450g/m ²	ca. 4 100g/m ²	ca. 4 600g/m ²
Technical performance							
Reaction to fire	EN 13501-1	C _s s1	C _s s1 (B _n s1 for Veneto xf ² ™ B _n)	C _s s1	C _s s1	C _s s1	C _s s1
Residual indentation	EN ISO 24343-1 Standard requirements Best measured value	≤ 0.15 mm ca. 0.07 mm	≤ 0.15 mm ca. 0.08 mm	≤ 0.15 mm ca. 0.10 mm	≤ 0.15 mm ca. 0.08 mm	≤ 0.30 mm ca. 0.20 mm	≤ 0.40 mm ca. 0.25 mm
Slip resistance	DIN 51130 EN 13893	R9 DS: ≥ 0.30	R9 DS: ≥ 0.30	R9 DS: ≥ 0.30	R9 DS: ≥ 0.30	R9 DS: ≥ 0.30	R9 DS: ≥ 0.30
Flexibility	ISO 24344 Method A	≤ 25mm	≤ 30mm	≤ 40mm	≤ 30mm	≤ 30mm	≤ 30mm
Castor chair	ISO 4918	Suitable for office chairs with castors type W (Norm EN 12529)					
Static electrical propensity	EN 1815	< 2kV	< 2kV	< 2kV	< 2kV	< 2kV	< 2kV
Chemical resistance	ISO 26987	Resistant to dilute acids, oils, fats, current solvents and alkalis					
Thermal resistance Underfloor heating	ISO 10456	0.012m ² K/W Suitable	0.015m ² K/W Suitable	0.019m ² K/W Suitable	0.040m ² K/W Suitable	0.042m ² K/W Suitable	0.045m ² K/W Suitable
Light fastness	EN ISO 105-B02 Method 3	≥ 6	≥ 6	≥ 6	≥ 6	≥ 6	≥ 6
Impact sound reduction	EN ISO 10140-3	5dB	6dB	8dB	18dB	15dB	15dB
Impact sound reduction with Elafono*	EN ISO 717-2	14dB	14dB	15dB	Not applicable		
Acoustic improvement	NF S31-074	Class C (Ln,e,w < 85dB)	Class C (Ln,e,w < 85dB)	Class B (Ln,e,w < 75dB)	Class A (Ln,e,w < 65dB)	Class B (Ln,e,w < 75dB)	
Determination of antibacterial activity	ISO 22196	Naturally bactericidal					

*Elafono: 2.0 mm traditional, 100% natural corkm underlay to be installed in combination with any compact Tarkett linoleum to get additional sound reduction (up to -15dB, depending on the product). Available in rolls ≤30 x 2m.

The above information is subject to modifications for the benefit of further improvement (02/2017). For more detailed technical information, please contact Tarkett.

 Grass	 Grege	 Sage
2.0mm: 14871 650 2.5mm: 14872 650 3.2mm: 14873 650 3.8mm: 14892 650 4.0mm: 14880 650 4.4mm: 14881 650	2.5mm: 14872 757 3.8mm: 14892 757 4.4mm: 14881 757	2.5mm: 14872 753 3.8mm: 14892 753 4.4mm: 14881 753

General Information

 Veneto xf ² ™ 2mm 0200-0010-DoP-2013-07 https://professionals.tarkett.com Manufactured by: Tarkett SpA 05035 Narni, ITALY According to European Classification ISO 10874 (EN 685)	 Veneto xf ² ™ 2.5mm 0200-0001-DoP-2013-07 https://professionals.tarkett.com Manufactured by: Tarkett SpA 05035 Narni, ITALY According to European Classification ISO 10874 (EN 685)	 Veneto Silencio xf ² ™ 3.8mm 0200-0027-DoP-2013-07 https://professionals.tarkett.com Manufactured by: Tarkett SpA 05035 Narni, ITALY According to European Classification ISO 10874 (EN 685)
 Veneto xf ² ™ 3.2mm 0200-0012-DoP-2013-07 https://professionals.tarkett.com Manufactured by: Tarkett SpA 05035 Narni, ITALY According to European Classification ISO 10874 (EN 685)	 Veneto B _n 2.5mm 0200-0014-DoP-2013-07 https://professionals.tarkett.com Manufactured by: Tarkett SpA 05035 Narni, ITALY According to European Classification ISO 10874 (EN 685)	 Acoustic Cork xf ² ™ 4mm 0200-0025-DoP-2013-07 https://professionals.tarkett.com Manufactured by: Tarkett SpA 05035 Narni, ITALY According to European Classification ISO 10874 (EN 685)

VENETO xf²™ Classical marbled Blues & Greens





Main Product Features

- Superior xf²™ protection for extreme mechanical and chemical toughness
- The classical marbled linoleum solution with soft or intense pattern variations for a timeless effect
- All 72 colours also available in Silencio xf²™ 18dB and on request on Acoustic Cork version



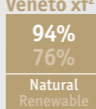

Surface Treatment





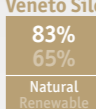

Sustainability Tag

 94% Renewable	 100% Recycled content	 PHTHALATE FREE	 ≤ 100 µg/m ³ Better Indoor Air Quality *TVOC AT 28 DAYS
--	--	---	---

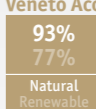





 83% Renewable	 100% Recycled content	 PHTHALATE FREE	 ≤ 100 µg/m ³ Better Indoor Air Quality *TVOC AT 28 DAYS
--	--	---	---

 93% Renewable	 100% Recycled content	 PHTHALATE FREE	 ≤ 100 µg/m ³ Better Indoor Air Quality *TVOC AT 28 DAYS
--	--	---	---



Logistics Information

-  (2.5mm) Available in rolls
Rolls length: ≤30lm
-  Silencio (3.8mm) Rolls length: ≤27lm
-  Acoustic Cork (4.0mm) Rolls length: ≤27lm
-  Acoustic Cork (4.4mm) Rolls length: ≤27lm

Laying direction: 

VENETO xf²™



VENETO xf²™ - Carmine

Eggshell	Sunflower	Coral	Turmeric	Rust
<ul style="list-style-type: none"> 2.5mm: 14872 619 3.8mm: 14892 619 4.4mm: 14881 619 	<ul style="list-style-type: none"> 2.5mm: 14872 628 3.8mm: 14892 628 4.4mm: 14881 628 	<ul style="list-style-type: none"> 2.5mm: 14872 615 3.8mm: 14892 615 4.4mm: 14881 615 	<ul style="list-style-type: none"> 2.5mm: 14872 919 3.8mm: 14892 919 4.4mm: 14881 919 	<ul style="list-style-type: none"> 2.5mm: 14872 739 3.8mm: 14892 739 4.4mm: 14881 739
Corn	Amber	Salmon	Carmine	Burgundy
<ul style="list-style-type: none"> 2.0mm: 14871 612 2.5mm: 14872 612 3.2mm: 14873 612 3.8mm: 14892 612 4.0mm: 14880 612 4.4mm: 14881 612 	<ul style="list-style-type: none"> 2.0mm: 14871 636 2.5mm: 14872 636 2.5mm B_R: 14898 636 3.2mm: 14873 636 3.8mm: 14892 636 4.0mm: 14880 636 4.4mm: 14881 636 	<ul style="list-style-type: none"> 2.5mm: 14872 642 3.8mm: 14892 642 4.4mm: 14881 642 	<ul style="list-style-type: none"> 2.5mm: 14872 645 3.8mm: 14892 645 4.4mm: 14881 645 	<ul style="list-style-type: none"> 2.5mm: 14872 744 3.8mm: 14892 744 4.4mm: 14881 744
Caramel	Pale pink	Copper	Crimson	Raspberry
<ul style="list-style-type: none"> 2.5mm: 14872 635 3.8mm: 14892 635 4.4mm: 14881 635 	<ul style="list-style-type: none"> 2.5mm: 14872 678 3.8mm: 14892 678 4.4mm: 14881 678 	<ul style="list-style-type: none"> 2.5mm: 14872 634 3.8mm: 14892 634 4.4mm: 14881 634 	<ul style="list-style-type: none"> 2.5mm: 14872 740 2.5mm B_R: 14898 740 3.8mm: 14892 740 4.4mm: 14881 740 	<ul style="list-style-type: none"> 2.5mm: 14872 945 3.8mm: 14892 945 4.4mm: 14881 945

TECHNICAL DATA	STANDARDS	Veneto xf ² ™ 2mm	Veneto xf ² ™ B _R 2.5mm	Veneto xf ² ™ 3.2mm	Veneto Silencio xf ² ™ 3.8mm	Veneto Acoustic Cork xf ² ™ 4mm	Veneto Acoustic Cork xf ² ™ 4.4mm
Classification							
Classification	ISO 10874 domestic commercial light industrial	Classes: 23 32 41	Classes: 23 34 43	Classes: 23 34 43	Classes: 23 33 41	Classes: 22 33 41	Classes: 23 34 42
Characteristics							
Surface Treatment		xf ² ™	xf ² ™	xf ² ™	xf ² ™	xf ² ™	xf ² ™
Total thickness	ISO 24346	2.00mm	2.50mm	3.20mm	3.80mm	4.0mm	4.4mm
Total weight	ISO 23997	ca. 2.400g/m ²	ca. 3.000g/m ²	ca. 3.900g/m ²	ca. 3.450g/m ²	ca. 4.100g/m ²	ca. 4.600g/m ²
Technical performance							
Reaction to fire	EN 13501-1	C _n s1	C _n s1 (B _n s1 for Veneto xf ² ™ B _R)	C _n s1	C _n s1	C _n s1	C _n s1
Residual indentation	EN ISO 24343-1 Standard requirements Best measured value	≤ 0.15 mm ca. 0.07 mm	≤ 0.15 mm ca. 0.08 mm	≤ 0.15 mm ca. 0.10 mm	≤ 0.15 mm ca. 0.08 mm	≤ 0.30 mm ca. 0.20 mm	≤ 0.40 mm ca. 0.25 mm
Slip resistance	DIN 51130 EN 13893	R9 DS: ≥ 0.30	R9 DS: ≥ 0.30	R9 DS: ≥ 0.30	R9 DS: ≥ 0.30	R9 DS: ≥ 0.30	R9 DS: ≥ 0.30
Flexibility	ISO 24344 Method A	≤ 25mm	≤ 30mm	≤ 40mm	≤ 30mm	≤ 30mm	≤ 30mm
Castor chair	ISO 4918	Suitable for office chairs with castors type W (Norm EN 12529)					
Static electrical propensity	EN 1815	< 2kV	< 2kV	< 2kV	< 2kV	< 2kV	< 2kV
Chemical resistance	ISO 26987	Resistant to dilute acids, oils, fats, current solvents and alkalis					
Thermal resistance Underfloor heating	ISO 10456	0.012m ² K/W Suitable	0.015m ² K/W Suitable	0.019m ² K/W Suitable	0.040m ² K/W Suitable	0.042m ² K/W Suitable	0.045m ² K/W Suitable
Light fastness	EN ISO 105-B02 Method 3	≥ 6	≥ 6	≥ 6	≥ 6	≥ 6	≥ 6
Impact sound reduction	EN ISO 10140-3	5dB	6dB	8dB	18dB	15dB	15dB
Impact sound reduction with Elafono*	EN ISO 717-2	14dB	14dB	15dB	Not applicable		
Acoustic improvement	NF S31-074	Class C (Ln,e,w < 85dB)	Class C (Ln,e,w < 85dB)	Class B (Ln,e,w < 75dB)	Class A (Ln,e,w < 65dB)	Class B (Ln,e,w < 75dB)	
Determination of antibacterial activity	ISO 22196	Naturally bactericidal					

*Elafono: 2.0 mm traditional, 100% natural corkm² underlay to be installed in combination with any compact Tarkett linoleum to get additional sound reduction (up to -15dB, depending on the product). Available in rolls ≤30 x 2m. The above information is subject to modifications for the benefit of further improvement (02/2017). For more detailed technical information, please contact Tarkett.

Terracotta	Pumpkin
<ul style="list-style-type: none"> 2.0mm: 14871 641 2.5mm: 14872 641 3.2mm: 14873 641 3.8mm: 14892 641 4.0mm: 14880 641 4.4mm: 14881 641 	<ul style="list-style-type: none"> 2.5mm: 14872 633 3.8mm: 14892 633 4.4mm: 14881 633

General Information

	Veneto xf²™ 2mm 0200-0010-DoP-2013-07 http://professionals.tarkett.com Manufactured by: Tarkett SpA 05035 Narni, ITALY EN 14041:2004		Veneto Silencio xf²™ 3.8mm 0200-0027-DoP-2013-07 http://professionals.tarkett.com Manufactured by: Tarkett SpA 05035 Narni, ITALY EN 14041:2004		Veneto xf²™ 2.5mm 0200-0001-DoP-2013-07 http://professionals.tarkett.com Manufactured by: Tarkett SpA 05035 Narni, ITALY EN 14041:2004		Veneto B_R 2.5mm 0200-0014-DoP-2013-07 http://professionals.tarkett.com Manufactured by: Tarkett SpA 05035 Narni, ITALY EN 14041:2004		Veneto xf²™ 3.2mm 0200-0012-DoP-2013-07 http://professionals.tarkett.com Manufactured by: Tarkett SpA 05035 Narni, ITALY EN 14041:2004		Acoustic Cork xf²™ 4mm 0200-0024-DoP-2013-07 http://professionals.tarkett.com Manufactured by: Tarkett SpA 05035 Narni, ITALY EN 14041:2004		Acoustic Cork xf²™ 4.4mm 0200-0025-DoP-2013-07 http://professionals.tarkett.com Manufactured by: Tarkett SpA 05035 Narni, ITALY EN 14041:2004
--	---	--	--	--	---	--	---	--	---	--	--	--	--

VENETO xf²™

Classical marbled Reds

Main Product Features

- Superior xf²™ protection for extreme mechanical and chemical toughness
- The classical marbled linoleum solution with soft or intense pattern variations for a timeless effect
- All 72 colours also available in Silencio xf²™ 18dB and on request on Acoustic Cork version

Surface Treatment



Sustainability Tag

Veneto xf²™	94% Natural Renewable	76% Recycled content	PHthalate FREE	≤ 100 µg/m ³ Better Indoor Air Quality
Veneto Silencio xf²™	83% Natural Renewable	65% Recycled content	100% PHthalate FREE	40% ≤ 100 µg/m ³ Better Indoor Air Quality
Veneto Acoustic Cork xf²™	93% Natural Renewable	77% Recycled content	100% PHthalate FREE	33% ≤ 100 µg/m ³ Better Indoor Air Quality

Logistics Information

- (2.5mm) Available in rolls
- (2.5mm) Rolls length: ≤30lm
- (3.8mm) Silencio (3.8mm) Rolls length: ≤27lm
- (4.0mm) Acoustic Cork (4.0mm) Rolls length: ≤27lm
- (4.4mm) Acoustic Cork (4.4mm) Rolls length: ≤27lm

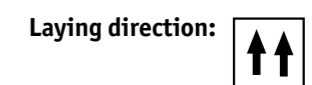

	Acoustic Cork xf²™ 4.4mm 0200-0025-DoP-2013-07 http://professionals.tarkett.com Manufactured by: Tarkett SpA 05035 Narni, ITALY EN 14041:2004		Acoustic Cork xf²™ 4.4mm 0200-0025-DoP-2013-07 http://professionals.tarkett.com Manufactured by: Tarkett SpA 05035 Narni, ITALY EN 14041:2004
--	--	--	--

STYLE ELLE xf²™



Style Elle xf²™ - Ferro



Sabbia

2.5mm: 14825 308
3.8mm: 14783 308



Mokka

2.5mm: 14825 317
3.8mm: 14783 317



Materia

2.5mm: 14825 300
3.8mm: 14783 300



Abisso

2.5mm: 14825 309
3.8mm: 14783 309



Arancione

2.5mm: 14825 318
3.8mm: 14783 318



Giallo

2.5mm: 14825 319
3.8mm: 14783 319



Ferro

2.5mm: 14825 305
3.8mm: 14783 305



Velluto

2.5mm: 14825 303
3.8mm: 14783 303



Rosso

2.5mm: 14825 314
3.8mm: 14783 314

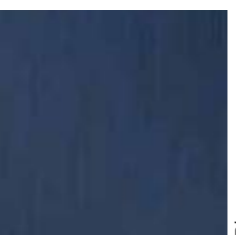

Blue

2.5mm: 14825 320
3.8mm: 14783 320

TECHNICAL DATA	STANDARDS	Style Elle xf ² ™ 2.5mm	Style Elle Silencio xf ² ™ 3.8mm
Classification			
Classification	ISO 10874 domestic commercial light industrial	Classes: 23 34 43	Classes: 23 33 41
Characteristics			
Surface Treatment		xf ² ™	xf ² ™
Total thickness	ISO 24346	2.50mm	3.80mm
Total weight	ISO 23997	ca. 3 000g/m ²	ca. 3 450g/m ²
Technical performance			
Reaction to fire	EN 13501-1	C _{s1} s1	
Residual indentation	EN ISO 24343-1 Standard requirements Best measured value	≤ 0.15 mm ca. 0.08 mm	≤ 0.30 mm ca. 0.20 mm
Slip resistance	DIN 51130 EN 13893	R9 DS: ≥ 0.30	
Flexibility	ISO 24344 Method A	≤ 30mm	≤ 30mm
Castor chair	ISO 4918	Suitable for office chairs with castors type W (Norm EN 12529)	
Static electrical propensity	EN 1815	< 2kV	
Chemical resistance	ISO 26987	Resistant to dilute acids, oils, fats, current solvents and alkalis	
Thermal resistance Underfloor heating	ISO 10456 (EN 12524)	0.015m ² K/W Suitable	0.040m ² K/W Suitable
Light fastness	EN ISO 105-B02 Method 3	≥ 6	
Impact sound reduction		6dB	18dB
Impact sound reduction with Elafono*	EN ISO 10140-3 EN ISO 717-2	14dB	Not applicable
Acoustic improvement	NF S31-074	Class C (Ln,e,w < 85dB)	Class A (Ln,e,w < 65dB)
Determination of antibacterial activity	ISO 22196	Naturally bactericidal	

*Elafono: 2.0 mm traditional, 100% natural cork underlay to be installed in combination with any compact Tarkett linoleum for additional sound reduction (up to -15dB, depending on the product). Available in rolls ≤30 x 2m.

The above information is subject to modifications for the benefit of further improvement (02/2017). For more detailed technical information, please contact Tarkett.



Verde

2.5mm: 14825 315
3.8mm: 14783 315

STYLE ELLE xf²™ Elegant linear tone on tone

Main Product Features

- Superior xf²™ protection for extreme mechanical and chemical toughness
- A discrete directional linear design tone on tone that can provide direction in corridors or open areas
- All 11 colours also available on request in acoustic version Silencio xf²™ 18dB
- Perfect matching with Style Emme range
- Design range where the natural patterned beauty of linoleum meets modern style

Surface Treatment



Sustainability Tag

Style Elle xf²™

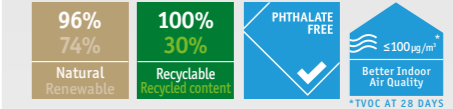

Style Elle Silencio xf²™

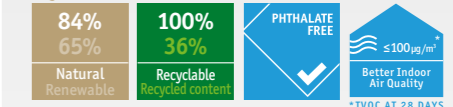

Logistics Information



(2.5mm) Available in rolls
Rolls length: ≤321m



(3.8mm) Silencio
Rolls length: ≤301m

Laying direction:



General Information



Style Elle xf²™ 2.5mm
0200-0031-DoP-2013-07
http://professionals.tarkett.com
Manufactured by Tarkett SpA
05035 Narni, ITALY



Style Elle Silencio xf²™ 3.8mm
0200-0027-DoP-2013-07
http://professionals.tarkett.com
Manufactured by Tarkett SpA
05035 Narni, ITALY



STYLE EMME xf²™



Style Emme xf²™ - Mokka

Sabbia	Mokka	Materia	Abisso	Arancione
2.5mm: 14835 208 3.8mm: 14782 208 4.4mm: 14102 208	2.5mm: 14835 217 3.8mm: 14782 217 4.4mm: 14102 217	2.5mm: 14835 200 3.8mm: 14782 200 4.4mm: 14102 200	2.5mm: 14835 209 3.8mm: 14782 209 4.4mm: 14102 209	2.5mm: 14835 218 3.8mm: 14782 218 4.4mm: 14102 218
Giallo	Ferro	Cemento	Asfalto	Velluto
2.5mm: 14835 219 3.8mm: 14782 219 4.4mm: 14102 219	2.5mm: 14835 205 3.8mm: 14782 205 4.4mm: 14102 205	2.5mm: 14835 202 3.8mm: 14782 202 4.4mm: 14102 202	2.5mm: 14835 207 3.8mm: 14782 207 4.4mm: 14102 207	2.5mm: 14835 203 3.8mm: 14782 203 4.4mm: 14102 203
Genere	Vulcano	Rosso	Verde	
2.5mm: 14835 201 3.8mm: 14782 201 4.4mm: 14102 201	2.5mm: 14835 216 3.8mm: 14782 216 4.4mm: 14102 216	2.5mm: 14835 214 3.8mm: 14782 214 4.4mm: 14102 214	2.5mm: 14835 215 3.8mm: 14782 215 4.4mm: 14102 215	



TECHNICAL DATA	STANDARDS	Style Emme xf ² ™ 2.5mm	Style Emme Silencio xf ² ™ 3.8mm	Style Emme Acoustic Cork xf ² ™ 4.4mm
Classification				
Classification	ISO 10874 domestic commercial light industrial	Classes: 23 34 43	Classes: 23 33 41	Classes: 23 34 42
Characteristics				
Surface Treatment		xf ² ™	xf ² ™	xf ² ™
Total thickness	ISO 24346	2.50mm	3.80mm	4.4mm
Total weight	ISO 23997	ca. 3 000g/m ²	ca. 3 450g/m ²	ca. 4 600g/m ²
Technical performance				
Reaction to fire	EN 13501-1	C _i s1		
Residual indentation	EN ISO 24343-1 Standard requirements Best measured value	≤ 0.15 mm ca. 0.08 mm	≤ 0.30 mm ca. 0.20 mm	≤ 0.40 mm ca. 0.25 mm
Slip resistance	DIN 51130 EN 13893	R9 DS: ≥ 0.30		
Flexibility	ISO 24344 Method A	≤ 30mm	≤ 30mm	≤ 30mm
Castor chair	ISO 4918	Suitable for office chairs with castors type W (Norm EN 12529)		
Static electrical propensity	EN 1815	< 2kV		
Chemical resistance	ISO 26987	Resistant to dilute acids, oils, fats, current solvents and alkalis		
Thermal resistance Underfloor heating	ISO 10456	0.015m ² K/W Suitable	0.040m ² K/W Suitable	0.045m ² K/W Suitable
Light fastness	EN ISO 105-B02 Method 3	≥ 6		
Impact sound reduction		6dB	18dB	15dB
Impact sound reduction with Elafono*	EN ISO 10140-3 EN ISO 717-2	14dB	Not applicable	
Acoustic improvement	NF S31-074	Class C (Ln,e,w < 85dB)	Class A (Ln,e,w < 65dB)	Class B (Ln,e,w < 75dB)
Determination of antibacterial activity	ISO 22196	Naturally bactericidal		

*Elafono: 2.0 mm traditional, 100% natural cork underlay to be installed in combination with any compact Tarkett linoleum for additional sound reduction (up to -15dB, depending on the product). Available in rolls ≤30 x 2m.
The above information is subject to modifications for the benefit of further improvement (02/2017). For more detailed technical information, please contact Tarkett.

	2.5mm: 14835 220 3.8mm: 14782 220 4.4mm: 14102 220
Blue	

General Information

	Style Emme xf²™ 2.5mm 0200-0034-DoP-2013-07 http://professionals.tarkett.com Manufactured by: Tarkett SpA 05035 Narni, ITALY EN 14041:2004			
	Style Emme Silencio xf²™ 3.8mm 0200-0027-DoP-2013-07 http://professionals.tarkett.com Manufactured by: Tarkett SpA 05035 Narni, ITALY EN 14041:2004			
	Acoustic Cork xf²™ 4.4mm 0200-0025-DoP-2013-07 http://professionals.tarkett.com Manufactured by: Tarkett SpA 05035 Narni, ITALY EN 14041:2004			

STYLE EMME xf²™

Discretely marbled tone on tone

Main Product Features

- Superior xf²™ protection for extreme mechanical and chemical toughness
- A discrete marbling tone on tone as a practical solution for maintaining a high quality appearance with a lasting impression of cleanliness.
- All 15 colours also available on request in acoustic version Silencio xf²™ 18dB and in Acoustic Cork xf²™ 15dB
- Perfect matching with Style Elle range
- Design range where the natural patterned beauty of linoleum meets modern style

Surface Treatment



Sustainability Tag

Style Emme xf²™	Style Emme Silencio xf²™	Style Emme Acoustic Cork xf²™
96% Natural Renewable	83% Natural Renewable	93% Natural Renewable
74% Recycled content	65% Recycled content	77% Recycled content
100% Recycled content	100% Recycled content	100% Recycled content
PHthalate FREE	PHthalate FREE	PHthalate FREE
≤ 100µg/m ³ Better Indoor Air Quality	≤ 100µg/m ³ Better Indoor Air Quality	≤ 100µg/m ³ Better Indoor Air Quality
*TVOC AT 28 DAYS	*TVOC AT 28 DAYS	*TVOC AT 28 DAYS



Style Emme xf²™	Style Emme Silencio xf²™	Style Emme Acoustic Cork xf²™
96% Natural Renewable	83% Natural Renewable	93% Natural Renewable
74% Recycled content	65% Recycled content	77% Recycled content
100% Recycled content	100% Recycled content	100% Recycled content
PHthalate FREE	PHthalate FREE	PHthalate FREE
≤ 100µg/m ³ Better Indoor Air Quality	≤ 100µg/m ³ Better Indoor Air Quality	≤ 100µg/m ³ Better Indoor Air Quality
*TVOC AT 28 DAYS	*TVOC AT 28 DAYS	*TVOC AT 28 DAYS

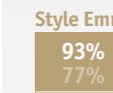

Style Emme xf²™	Style Emme Silencio xf²™	Style Emme Acoustic Cork xf²™
96% Natural Renewable	83% Natural Renewable	93% Natural Renewable
74% Recycled content	65% Recycled content	77% Recycled content
100% Recycled content	100% Recycled content	100% Recycled content
PHthalate FREE	PHthalate FREE	PHthalate FREE
≤ 100µg/m ³ Better Indoor Air Quality	≤ 100µg/m ³ Better Indoor Air Quality	≤ 100µg/m ³ Better Indoor Air Quality
*TVOC AT 28 DAYS	*TVOC AT 28 DAYS	*TVOC AT 28 DAYS



Logistics Information

- (2.5mm) Available in rolls
Rolls length: ≤321m
- Silencio (3.8mm) Rolls length: ≤301m
- Acoustic Cork (4.4mm) Rolls length: ≤301m

Laying direction:



ETRUSCO xf²™



Etrusco xf²™ - Silver





				
Black	Silver	Beige	Red Berlin	Red
 2.5mm: 14877 098  3.8mm: 14894 098	 2.5mm: 14877 003  3.8mm: 14894 003	 2.5mm: 14877 002  3.8mm: 14894 002	 2.5mm: 14877 094  3.8mm: 14894 094	 2.5mm: 14877 041  3.8mm: 14894 041
				
Orange	Yellow	Anise	Rainforest	Indigo
 2.5mm: 14877 037  3.8mm: 14894 037	 2.5mm: 14877 036  3.8mm: 14894 036	 2.5mm: 14877 095  3.8mm: 14894 095	 2.5mm: 14877 053  3.8mm: 14894 053	 2.5mm: 14877 066  3.8mm: 14894 066
				
Cyan	Iris	Amaranth		
 2.5mm: 14877 061  3.8mm: 14894 061	 2.5mm: 14877 048  3.8mm: 14894 048	 2.5mm: 14877 042  3.8mm: 14894 042		

TECHNICAL DATA	STANDARDS	Etrusco xf ² ™ 2.5mm	Etrusco Silencio xf ² ™ 3.8mm
Classification			
Classification	ISO 10874 domestic commercial light industrial	Classes: 23 34 43	Classes: 23 33 41
Characteristics			
Surface Treatment		xf ² ™	xf ² ™
Total thickness	ISO 24346	2.50mm	3.80mm
Total weight	ISO 23997	ca. 3 000g/m ²	ca. 3 450g/m ²
Technical performance			
Reaction to fire	EN 13501-1	C _{s1} s1	
Residual indentation	EN ISO 24343-1 Standard requirements Best measured value	≤ 0.15 mm ca. 0.08 mm	≤ 0.30 mm ca. 0.20 mm
Slip resistance	DIN 51130 EN 13893	R9 DS: ≥ 0.30	
Flexibility	ISO 24344 Method A	≤ 30mm	≤ 30mm
Castor chair	ISO 4918	Suitable for office chairs with castors type W (Norm EN 12529)	
Static electrical propensity	EN 1815	< 2kV	
Chemical resistance	ISO 26987	Resistant to dilute acids, oils, fats, current solvents and alkalis	
Thermal resistance Underfloor heating	ISO 10456 (EN 12524)	0.015m ² K/W Suitable	0.040m ² K/W Suitable
Light fastness	EN ISO 105-B02 Method 3	≥ 6	
Impact sound reduction	EN ISO 10140-3 EN ISO 717-2	6dB	18dB
Impact sound reduction with Elafono*		14dB	Not applicable
Acoustic improvement	NF S31-074	Class C (Ln,e,w < 85dB)	Class A (Ln,e,w < 65dB)
Determination of antibacterial activity	ISO 22196	Naturally bactericidal	

*Elafono: 2.0 mm traditional, 100% natural cork underlay to be installed in combination with any compact Tarkett linoleum for additional sound reduction (up to -15dB, depending on the product). Available in rolls ≤30 x 2m.

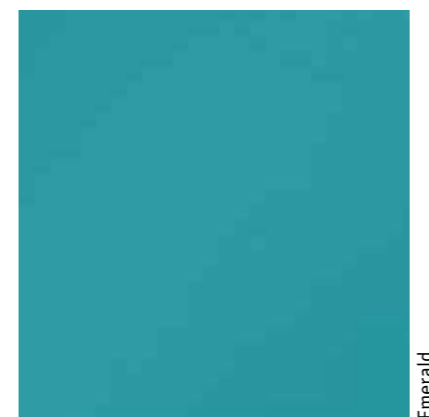
The above information is subject to modifications for the benefit of further improvement (02/2017). For more detailed technical information, please contact Tarkett.



 2.5mm: 14877 054
 3.8mm: 14894 054

ETRUSCO xf²™ The solid design

Main Product Features

- Superior xf²™ protection for extreme mechanical and chemical toughness
- Plain design with deep and radiant colours
- All 14 colours also available on request in Silencio xf²™ 18dB
- To be easily combined with any other linoleum pattern

Surface Treatment



Sustainability Tag

Etrusco xf²™

93% 77% Natural Renewable	100% 34% Recyclable Recycled content	PHTHALATE FREE	≤ 100µg/m ³ Better Indoor Air Quality *TVOC AT 28 DAYS
------------------------------------	---	-------------------	--



Etrusco Silencio xf²™

81% 67% Natural Renewable	100% 40% Recyclable Recycled content	PHTHALATE FREE	≤ 100µg/m ³ Better Indoor Air Quality *TVOC AT 28 DAYS
------------------------------------	---	-------------------	--

Logistics Information

 (2.5mm) **Available in rolls**
Rolls length: ≤ 321m

 Silencio (3.8mm) **Rolls length: ≤ 301m**

Laying direction: 

General Information

Etrusco xf²™ 2.5mm
0200-0020-DoP-2013-07
<http://professionals.tarkett.com>
Manufactured by Tarkett SpA
05035 Nemi, ITALY
EN 14041:2004
According to European
Classification ISO 10874 (EN 685)

Etrusco Silencio xf²™ 3.8mm
0200-0027-DoP-2013-07
<http://professionals.tarkett.com>
Manufactured by Tarkett SpA
05035 Nemi, ITALY
EN 14041:2004
According to European
Classification ISO 10874 (EN 685)



VENETO SICURO xf²™ R10



Veneto Sicuro xf²™ R10 - Aluminium

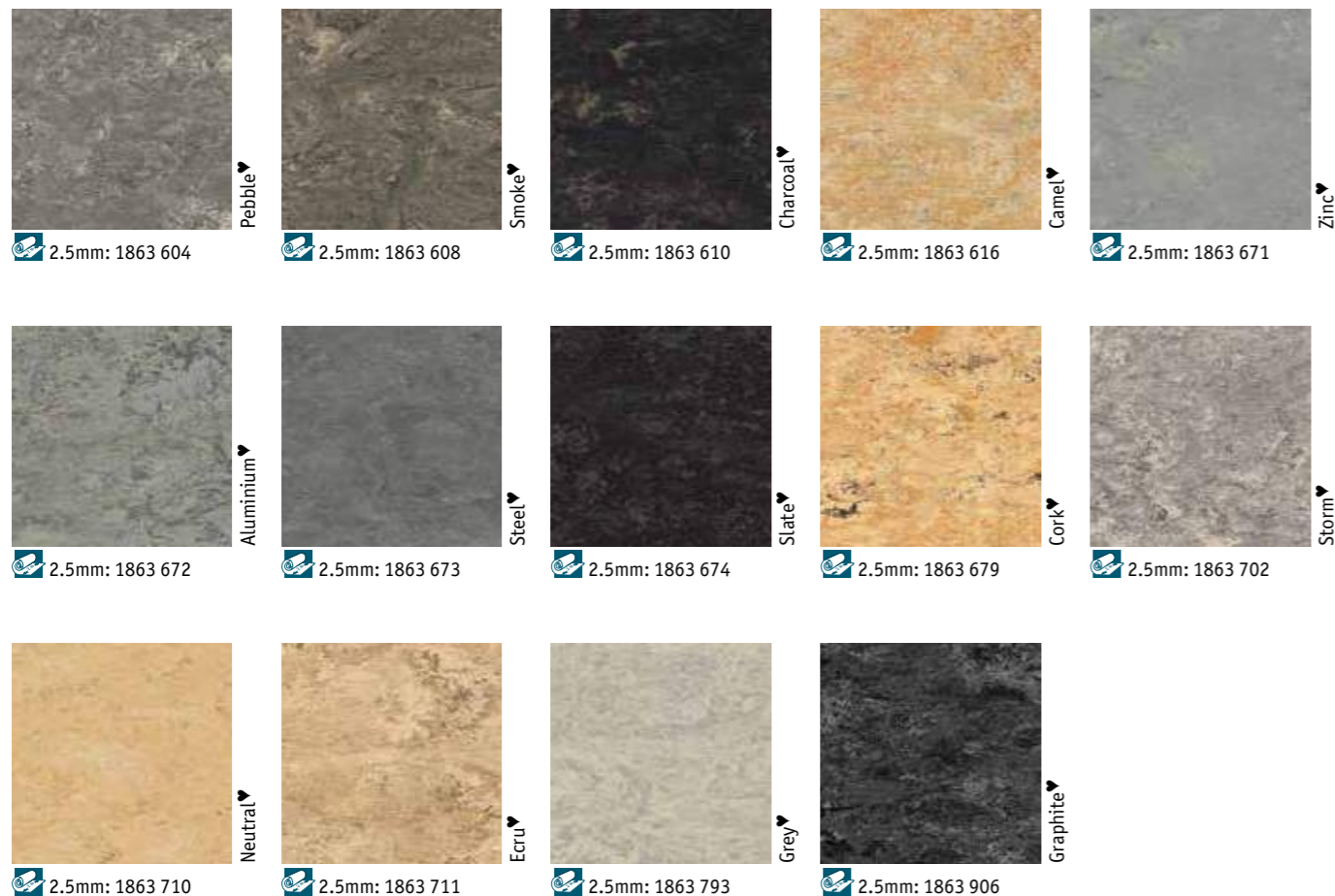

♥ Grands Classiques

TECHNICAL DATA	STANDARDS	Veneto Sicuro xf ² ™ R10 2.5mm
Classification		
Classification	ISO 10874 domestic commercial light industrial	Classes: 23 34 43
Characteristics		
Surface Treatment		xf ² ™
Total thickness	ISO 24346	2.50mm
Total weight	ISO 23997	ca. 3 000g/m ²
Technical performance		
Reaction to fire	EN 13501-1	C _i s1
Residual indentation	EN ISO 24343-1 Standard requirements Best measured value	≤ 0.15 mm ca. 0.08 mm
Slip resistance	DIN 51130 EN 13893	R10 DS: ≥ 0.30
Flexibility	ISO 24344 Method A	≤ 30mm
Castor chair	ISO 4918	Suitable for office chairs with castors type W (Norm EN 12529)
Static electrical propensity	EN 1815	< 2kV
Chemical resistance	ISO 26987	Resistant to dilute acids, oils, fats, current solvents and alkalis
Thermal resistance Underfloor heating	ISO 10456	0.015m ² K/W Suitable
Light fastness	EN ISO 105-B02 Method 3	≥ 6
Impact sound reduction		6dB
Impact sound reduction with Elafono*	EN ISO 10140-3 EN ISO 717-2	14dB
Acoustic improvement	NF S31-074	Class C (Ln, e, w < 85dB)
Determination of antibacterial activity	ISO 22196	Naturally bactericidal

*Elafono: 2.0 mm traditional, 100% natural cork underlay to be installed in combination with any compact Tarkett linoleum for additional sound reduction (up to -15dB, depending on the product). Available in rolls ≤30 x 2m.

The above information is subject to modifications for the benefit of further improvement (02/2017). For more detailed technical information, please contact Tarkett.



2.5mm: 1863 611

VENETO SICURO xf²™ R10

Higher slip rating R10

Main Product Features

- Superior xf²™ protection for extreme mechanical and chemical toughness
- R10 secure grip combined with the ease of cleaning of xf²™
- 29 colours classical marbled design available on request
- 20 colours are among the 20 Grands Classiques

Surface Treatment



Sustainability Tag

Veneto Sicuro xf²™

94% 75%	100% 34%	PHTHALATE FREE	≤100µg/m ³ Better Indoor Air Quality
Natural Renewable	Recyclable Recycled content		*TVOC AT 28 DAYS



Logistics Information



(2.5mm)

Available in rolls
Rolls length: ≤321m

Laying direction:



General Information

CE

Veneto xf²™ 2.5mm

0200-0001-DoP-2013-07
http://professionals.tarkett.com

Manufactured by Tarkett SpA
05035 Narni, ITALY

EN 14041:2004

According to European Classification ISO 10874 (EN 685)

VENETO SICURO xf²™ R10



Veneto Sicuro xf²™ R10 - Horizon

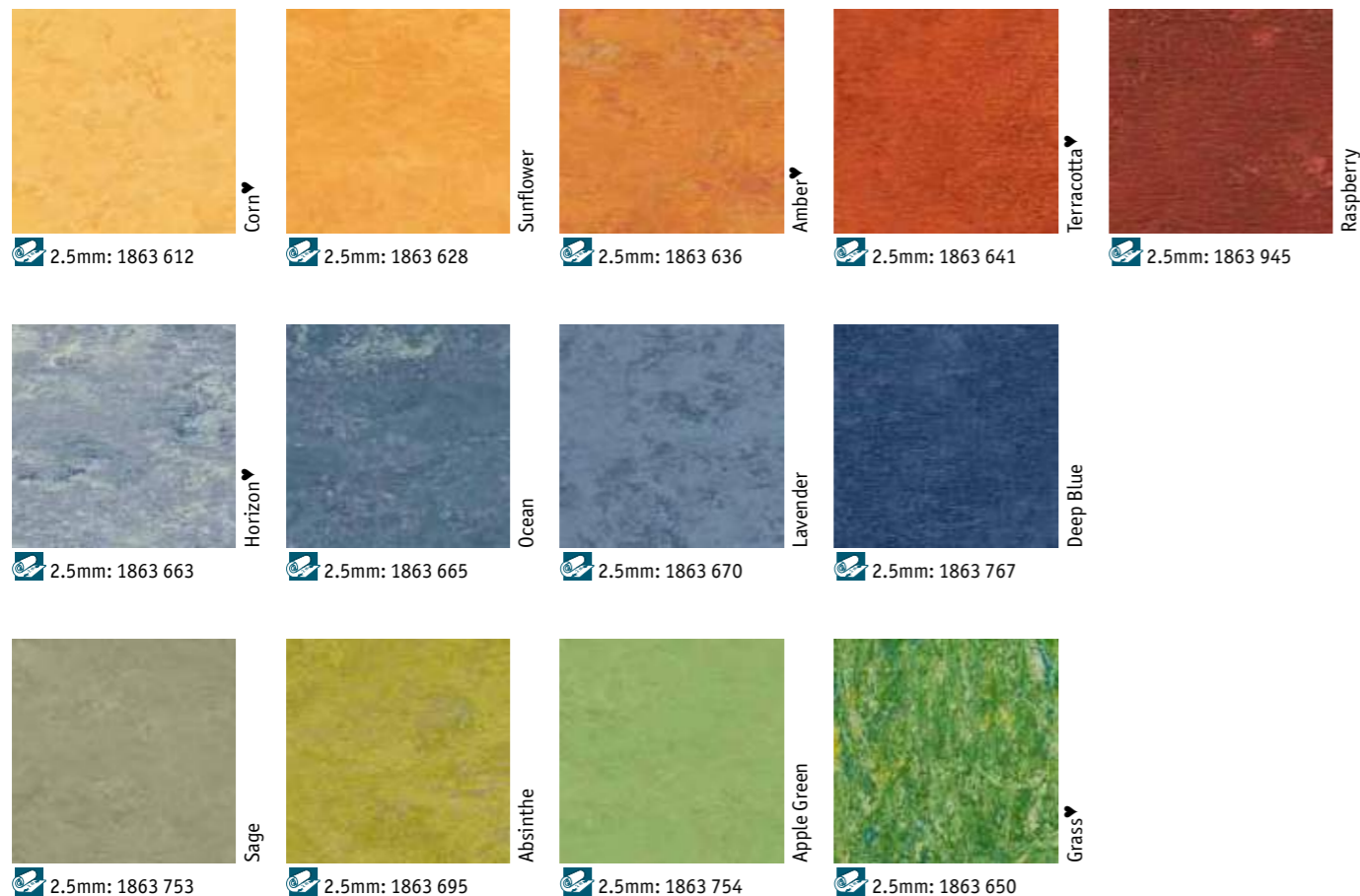

TECHNICAL DATA	STANDARDS	Veneto Sicuro xf ² ™ R10 2.5mm
Classification		
Classification	ISO 10874 domestic commercial light industrial	Classes: 23 34 43
Characteristics		
Surface Treatment		xf ² ™
Total thickness	ISO 24346	2.50mm
Total weight	ISO 23997	ca. 3 000g/m ²
Technical performance		
Reaction to fire	EN 13501-1	C _{fl} s1
Residual indentation	EN ISO 24343-1 Standard requirements Best measured value	≤ 0.15 mm ca. 0.08 mm
Slip resistance	DIN 51130 EN 13893	R10 DS: ≥ 0.30
Flexibility	ISO 24344 Method A	≤ 30mm
Castor chair	ISO 4918	Suitable for office chairs with castors type W (Norm EN 12529)
Static electrical propensity	EN 1815	< 2kV
Chemical resistance	ISO 26987	Resistant to dilute acids, oils, fats, current solvents and alkalis
Thermal resistance Underfloor heating	ISO 10456	0.015m ² K/W Suitable
Light fastness	EN ISO 105-B02 Method 3	≥ 6
Impact sound reduction		6dB
Impact sound reduction with Elafono*	EN ISO 10140-3 EN ISO 717-2	14dB
Acoustic improvement	NF S31-074	Class C (Ln, e, w < 85dB)
Determination of antibacterial activity	ISO 22196	Naturally bactericidal

*Elafono: 2.0 mm traditional, 100% natural cork underlay to be installed in combination with any compact Tarkett linoleum for additional sound reduction (up to -15dB, depending on the product). Available in rolls ≤30 x 2m.

The above information is subject to modifications for the benefit of further improvement (02/2017). For more detailed technical information, please contact Tarkett.



2.5mm: 1863 619

Eggs'hell

VENETO SICURO xf²™ R10 Higher slip rating R10

Main Product Features

- Superior xf²™ protection for extreme mechanical and chemical toughness
- R10 secure grip combined with the ease of cleaning of xf²™
- 29 colours classical marbled design available on request
- 20 colours are among the 20 Grands Classiques

Surface Treatment



Sustainability Tag

Veneto Sicuro xf²™

94% 75%	100% 34%	PHthalate FREE	≤100µg/m ³ Better Indoor Air Quality
Natural Renewable	Recyclable Recycled content		*TVOC AT 28 DAYS



Logistics Information



(2.5mm)

Available in rolls
Rolls length: ≤321m

Laying direction:



General Information

CE EN 14041:2004

Sicuro xf²™ R10
0200-0005-DoP-2013-07
http://professionals.tarkett.com

Manufactured by: Tarkett SpA
05035 Narni, ITALY

According to European Classification ISO 10874 (EN 685)



VENETO ESSENZA



The linoleum collection with a traditional, factory-applied acrylic finish that is non-permanent and PU-free, perfect for educational and office environments

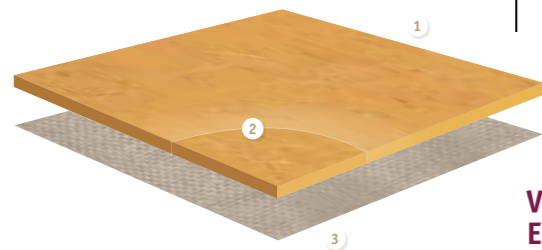

VENETO ESSENZA

- 1 Non permanent factory-applied acrylic finish
- 2 Pure linoleum stable design throughout product lifetime
- 3 Jute backing natural, 100% bio-degradable

SENSORY BENEFITS

- Natural look
- 30 colours in the classic marbled design
- 30 colours available to order in Acoustic Cork 15dB version
- 20 colours feature in the Grands Classiques♥ range, guaranteed to remain in production until 2033
- Matching accessories, including multicolour welding rods for Grands Classiques

FUNCTIONAL BENEFITS

- Ready to walk on: no initial wax or polish needed
- Gloss level adjustable by polishing

- Naturally bactericidal

ENVIRONMENTAL BENEFITS

- Natural, recyclable flooring made from sustainable materials
- C2C Gold made from natural ingredients and without the use of pigments (cf p.387)
- Contributes to better indoor air quality (FloorScore® certified)
- Non-PU surface protection

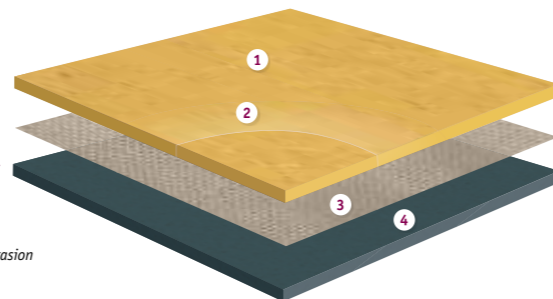

VENETO ACOUSTIC CORK ESSENZA 15dB

- 1 xF2™ surface treatment improved performance and resistance to abrasion
- 2 Pure linoleum stable design throughout product lifetime
- 3 Jute backing natural, 100% bio-degradable
- 4 Cork Acoustic backing 15dB sound reduction

TECHNICAL DATA	STANDARDS	Veneto Eszenza 2.5mm	Veneto Acoustic Cork Eszenza 4.4mm
Classification			
Classification	ISO 10874 domestic commercial light industrial	Classes: 23 34 43	Classes: 23 34 42
Characteristics			
Surface Treatment		acrylic	
Total thickness	ISO 24346	2.50mm	4.4mm
Total weight	ISO 23997	ca. 3 000g/m ²	ca. 4 600g/m ²
Technical performance			
Reaction to fire	EN 13501-1	C _r s1	
Residual indentation	EN ISO 24343-1 Standard requirements Best measured value	≤ 0.15 mm ca. 0.08 mm	≤ 0.40 mm ca. 0.25 mm
Slip resistance	DIN 51130 EN 13893	R9 DS: ≥ 0.30	
Flexibility	EN ISO 24344 Method A	≤ 30mm	
Castor chair	ISO 4918	Suitable for office chairs with castors type W (Norm EN 12529)	
Static electrical propensity	EN 1815	< 2kV	
Chemical resistance	ISO 26987	Resistant to dilute acids,oils, fats, current solvents	
Thermal resistance Underfloor heating	ISO 10456	0.015m ² K/W Suitable	0.045m ² K/W Suitable
Light fastness	EN ISO 105-B02 Method 3	≥ 6	
Impact sound reduction		6dB	15dB
Impact sound reduction with Elafono*	EN ISO 10140-3 EN ISO 717-2	14dB	Not applicable
Acoustic improvement	NF S31-074	Class C (Ln,e,w < 85dB)	Class B (Ln,e,w < 75dB)
Determination of antibacterial activity	ISO 22196	Naturally bactericidal	
Form of delivery	ISO 24341	≤ 32 x 2m	< 30 x 2 m or < 30 x 1.95 m (subject to availability-please check upon order)
Colours		30	on request: 30

*Elafono: 2.0 mm traditional, 100% natural cork underlay to be installed in combination with any compact Tarkett linoleum for additional sound reduction (up to -15dB, depending on the product). Available in rolls ≤30 x 2m.

The above information is subject to modifications for the benefit of further improvement (02/2017). For more detailed technical information, please contact Tarkett.

Grands Classiques♥, a selection of 20 timeless colours guaranteed to remain in production until 2033 in the following options:

- 2.0 - 2.5 - 3.2mm Veneto xF2™
- 2.5mm Veneto Sicuro xF2™ R10
- 2.5mm Veneto Eszenza
- 3.8mm Veneto Silencio xF2™ 18dB
- 4.0mm Veneto Acoustic Cork xF2™ 15dB
- 4.4mm Veneto Acoustic Cork xF2™ 15dB
- 4.4mm Veneto Acoustic Cork Eszenza 15dB

Find them on the following pages marked with ♥. Multicolor welding rods available.















All our linoleum ranges*
*Except Silencio, Linoleum SD xF2 and Linoleum Conductive xF2 ranges



VENETO ESSENZA

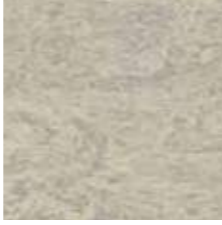
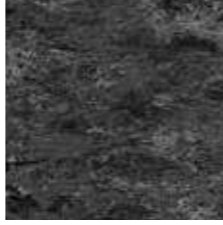

Essenza - Zinc

				
Pebble	Smoke	Charcoal	Camel	Zinc
2.5mm: 1805 604 4.4mm: 14882 604	2.5mm: 1805 608 4.4mm: 14882 608	2.5mm: 1805 610 4.4mm: 14882 610	2.5mm: 1805 616 4.4mm: 14882 616	2.5mm: 1805 671 4.4mm: 14882 671
				
Aluminium	Steel	Slate	Cork	Storm
2.5mm: 1805 672 4.4mm: 14882 672	2.5mm: 1805 673 4.4mm: 14882 673	2.5mm: 1805 674 4.4mm: 14882 674	2.5mm: 1805 679 4.4mm: 14882 679	2.5mm: 1805 702 4.4mm: 14882 702
				
Sisal	Neutral	Ecru	Grey	Graphite
2.5mm: 1805 611 4.4mm: 14882 611	2.5mm: 1805 710 4.4mm: 14882 710	2.5mm: 1805 711 4.4mm: 14882 711	2.5mm: 1805 793 4.4mm: 14882 793	2.5mm: 1805 906 4.4mm: 14882 906

♥ Grands Classiques

TECHNICAL DATA	STANDARDS	Veneto Essenza 2.5mm	Veneto Acoustic Cork Essenza 4.4mm
Classification			
Classification	ISO 10874 domestic commercial light industrial	Classes: 23 34 43	Classes: 23 34 42
Characteristics			
Surface Treatment		acrylic	acrylic
Total thickness	ISO 24346	2.50mm	4.4mm
Total weight	ISO 23997	ca. 3 000g/m ²	ca. 4 600g/m ²
Technical performance			
Reaction to fire	EN 13501-1	C _s s1	
Residual indentation	EN ISO 24343-1 Standard requirements Best measured value	≤ 0.15 mm ca. 0.08 mm	≤ 0.40 mm ca. 0.25 mm
Slip resistance	DIN 51130 EN 13893	R9 DS: ≥ 0.30	
Flexibility	ISO 24344 Method A	≤ 30mm	
Castor chair	ISO 4918	Suitable for office chairs with castors type W (Norm EN 12529)	
Static electrical propensity	EN 1815	< 2kV	
Chemical resistance	ISO 26987	Resistant to dilute acids, oils, fats, current solvents	
Thermal resistance Underfloor heating	ISO 10456	0.015m ² K/W Suitable	0.045m ² K/W Suitable
Light fastness	EN ISO 105-B02 Method 3	≥ 6	
Impact sound reduction		6dB	15dB
Impact sound reduction with Elafono*	EN ISO 10140-3 EN ISO 717-2	14dB	Not applicable
Acoustic improvement	NF S31-074	Class C (Ln,e,w < 85dB)	Class B (Ln,e,w < 75dB)
Determination of antibacterial activity	ISO 22196	Naturally bactericidal	

*Elafono: 2.0 mm traditional, 100% natural cork underlay to be installed in combination with any compact Tarkett linoleum for additional sound reduction (up to -15dB, depending on the product). Available in rolls ≤30 x 2m.
The above information is subject to modifications for the benefit of further improvement (02/2017). For more detailed technical information, please contact Tarkett.



VENETO ESSENZA 100% LINEN
The ONLY linoleum awarded with **C2C GOLD**



2.5mm: 1805 400
4.4mm: 14882 400

VENETO ESSENZA

Traditional linoleum with acrylic finish surface protection

Main Product Features

- Ready to walk on: no initial wax or polish needed
- Non-PU surface protection
- Gloss level adjustable by polishing
- Selection from the classical marbled design
- All 30 colours available on request in the Acoustic Cork 15dB version
- Essenza 100% linen awarded C2C Gold

Surface Treatment

factory-applied acrylic finish

Sustainability Tag

Veneto Essenza

96% 76% Natural Renewable	100% 35% Recyclable Recycled content	PHthalate FREE	≤ 100µg/m ³ Better Indoor Air Quality
---------------------------------	--	----------------	---

*TVOC AT 28 DAYS



Veneto Acoustic Cork

93% 77% Natural Renewable	100% 33% Recyclable Recycled content	PHthalate FREE	≤ 100µg/m ³ Better Indoor Air Quality
---------------------------------	--	----------------	---

*TVOC AT 28 DAYS



Logistics Information

- (2.5mm) Available in rolls
Rolls length: ≤321m
- Acoustic Cork (4.4mm) Available in rolls
Rolls length: ≤271m

Laying direction: ↑↑

General Information

	Veneto Essenza 2.5mm 0200-0011-DoP-2013-07 http://professionals.tarkett.com Manufactured by Tarkett SpA 05035 Narni, ITALY	
	Acoustic Cork xF™ 4.4mm 0200-0025-DoP-2013-07 http://professionals.tarkett.com Manufactured by Tarkett SpA 05035 Narni, ITALY	



VENETO ESSENZA



VENETO xf²™ - Aluminium

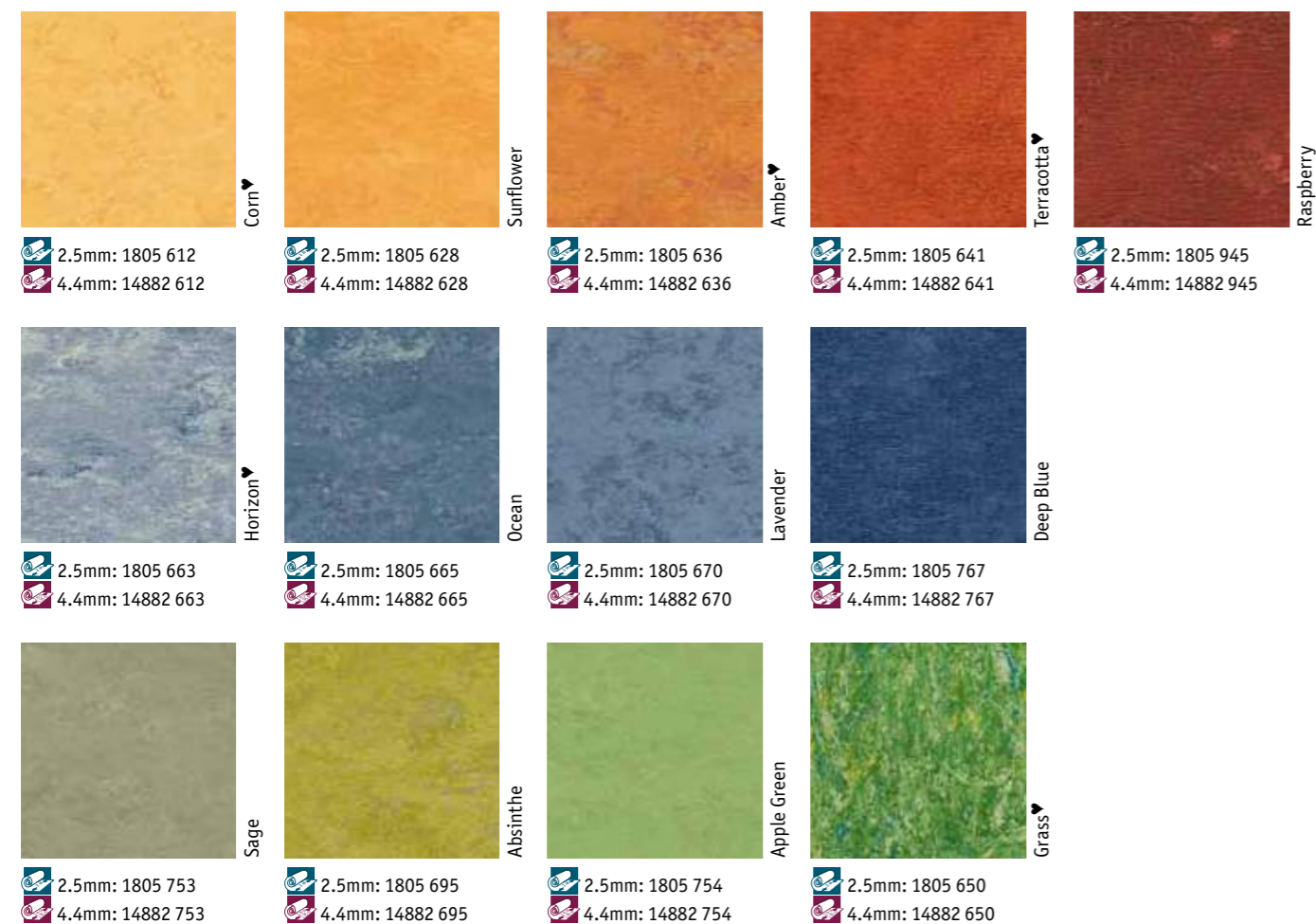

▼ Grands Classiques

TECHNICAL DATA	STANDARDS	Veneto Eszenza 2.5mm	Veneto Acoustic Cork Eszenza 4.4mm
Classification			
Classification	ISO 10874 domestic commercial light industrial	Classes: 23 34 43	Classes: 23 34 42
Characteristics			
Surface Treatment		acrylic	acrylic
Total thickness	ISO 24346	2.50mm	4.4mm
Total weight	ISO 23997	ca. 3 000g/m ²	ca. 4 600g/m ²
Technical performance			
Reaction to fire	EN 13501-1	C _s s1	
Residual indentation	EN ISO 24343-1 Standard requirements Best measured value	≤ 0.15 mm ca. 0.08 mm	≤ 0.40 mm ca. 0.25 mm
Slip resistance	DIN 51130 EN 13893	R9 DS: ≥ 0.30	
Flexibility	ISO 24344 Method A	≤ 30mm	
Castor chair	ISO 4918	Suitable for office chairs with castors type W (Norm EN 12529)	
Static electrical propensity	EN 1815	< 2kV	
Chemical resistance	ISO 26987	Resistant to dilute acids, oils, fats, current solvents	
Thermal resistance Underfloor heating	ISO 10456	0.015m ² K/W Suitable	0.045m ² K/W Suitable
Light fastness	EN ISO 105-B02 Method 3	≥ 6	
Impact sound reduction		6dB	15dB
Impact sound reduction with Elafono*	EN ISO 10140-3 EN ISO 717-2	14dB	Not applicable
Acoustic improvement	NF S31-074	Class C (Ln,e,w < 85dB)	Class B (Ln,e,w < 75dB)
Determination of antibacterial activity	ISO 22196	Naturally bactericidal	

*Elafono: 2.0 mm traditional, 100% natural cork underlay to be installed in combination with any compact Tarkett linoleum for additional sound reduction (up to -15dB, depending on the product). Available in rolls ≤30 x 2m.

The above information is subject to modifications for the benefit of further improvement (02/2017). For more detailed technical information, please contact Tarkett.



2.5mm: 1805 619
4.4mm: 14882 619

VENETO ESSENZA

Traditional linoleum with acrylic finish surface protection

Main Product Features

- Ready to walk on: no initial wax or polish needed
- Non-PU surface protection
- Gloss level adjustable by polishing
- Selection from the classical marbled design

Surface Treatment

factory-applied acrylic finish

Sustainability Tag

Veneto Eszenza

- 96% Natural Renewable
- 76% Recyclable Recycled content
- 100% Recyclable Recycled content
- 35% Recyclable Recycled content
- PHthalate FREE
- ≤100µg/m³ Better Indoor Air Quality
- *TVOC AT 28 DAYS



Veneto Acoustic Cork

- 93% Natural Renewable
- 77% Recyclable Recycled content
- 100% Recyclable Recycled content
- 33% Recyclable Recycled content
- PHthalate FREE
- ≤100µg/m³ Better Indoor Air Quality
- *TVOC AT 28 DAYS



Logistics Information

- (2.5mm) Available in rolls Rolls length: ≤321m
- Acoustic Cork (4.4mm) Available in rolls Rolls length: ≤271m

Laying direction: ↑↑

General Information

Veneto Eszenza
0200-0011-DoP-2013-07
http://professionals.tarkett.com
Manufactured by Tarkett SpA
05035 Narni, ITALY
EN 14041:2004
According to European Classification ISO 10874 (EN 685)

Acoustic Cork 4.4mm
0200-0025-DoP-2013-07
http://professionals.tarkett.com
Manufactured by Tarkett SpA
05035 Narni, ITALY
EN 14041:2004
According to European Classification ISO 10874 (EN 685)

