



ACCESSORIES

Accessories for resilient floorings	
Core accessories	p. 562
Accessibility	p. 564
Specialties	p. 578

Underlay & overlay solutions	p. 584
---	--------

Floorcraft	p. 594
-------------------	--------

Accessories for hard floorings	p. 594
Wood	p. 594
Laminate	p. 596
Underlayers	p. 604

Accessories for sports floorings	p. 606
---	--------



ACCESSORIES FOR RESILIENT FLOORINGS



WELDING ■ PVC WELDING RODS

■ COLD WELDING

Creation of a watertight joint which is necessary to prevent any penetration of water after the vinyl floorcovering has been laid.

Name of the product	Reference	Description	Logistic information
Cold welding - Commercial use	Type A	Specially designed for PVC floorcoverings that have been overlapped and double cut.	Art code: 1490 002 1 box of 24 tubes A tube for a 20 lm welding
Cold welding - Commercial use	Type C	Specially designed for PVC floorcoverings with joint opening from 0.3 mm to 4 mm.	Art code: 1490 003 1 box of 24 tubes A tube for a 10 to 15 lm welding

■ HOT WELDING FOR VINYL FLOORINGS

Name of the product	Reference	Logistic information	
Welding rods	Unicolor: 1287 --- 1288 --- 1289 --- 1290 011 > 1290 018 1291 --- 1291 --- 1292 --- 1294 --- 24806 ---	Multicolor: 1290 --- (except 011 > 018) 1439 --- 26760 --- 26761 --- 26762 ---	diameter= 4mm 1 bobbin of 50lm

Name of the product	Reference	Logistic information
Welding rods	iQ Natural Unicolor: 1296 --- Multicolor: 1297 ---	diameter= 4mm 1 bobbin of 50lm

■ HOT WELDING FOR VINYL SPORTS FLOORINGS

Name of the product	Logistic information
Welding rods - Omnisports Speed / Compact	diameter= 4mm / 1 bobbin of 50lm 1291 ---
Welding rods - Omnisports Training / Reference / Excel / Pure play	diameter= 5mm / 1 bobbin of 50lm 1285 ---

WELDING ■ NON-PVC WELDING RODS

■ HOT WELDING FOR VINYL FLOORINGS

Name of the product	Reference	Logistic information
Welding rods	iQ One Unicolor: 21201 ---	diameter= 4mm 1 bobbin of 50lm

■ HOT WELDING FOR LINOLEUM FLOORINGS

Name of the product	Reference	Logistic information
Welding rods	Unicolor: 1751 --- Available in stock for the compact linoleum range	diameter= 4mm 1 bobbin of 50lm
Welding rods	Multicolor: 14000 --- Available in stock for the 20 Grands Classiques compact linoleum colours	diameter= 4mm 1 bobbin of 40lm
Welding rods	Unicolor: 14051 --- Available in stock for the acoustic linoleum range	diameter= 4,4mm 1 bobbin of 40lm

All Tarkett resilient ranges offer a complete list of matching unicolour or multicolour welding rods according to the design and colour chosen.
Please refer to:

<http://professionals.tarkett.com> (under Products / Accessories / Welding rods)

TRANSITION PROFILES ■ EXPANSION JOINTS FOR ROLLS

■ EXPANSION JOINTS

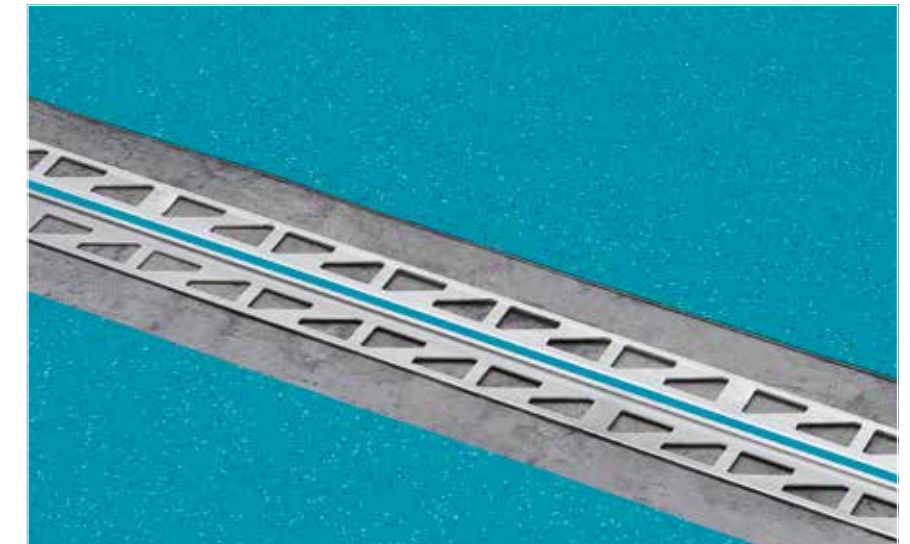
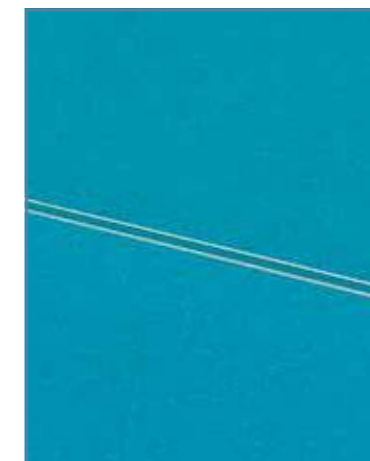

Screed and expansion joints are made in nearly all buildings and have to be taken over by the floor. If no joints are made, the floor covering may tear or dish, which would require complex and costly repair.
Expansion joint sections offer a perfect solution to avoid such problems.

2.3/3.7x2500mm, made upon request in any colour for perfect matching

Ordering unit: 1 box of 10 pcs = 25lm

Art codes: **Expansion joint 2.2:** 26600 --- (for 2.00mm compact flooring)
Expansion joint 3.7: 26601 --- (for 3.0/3.5mm acoustic flooring)



ACCESSORIES FOR RESILIENT FLOORINGS

COVING ■ PVC COVE FORMERS & CAPPINGS

■ PVC COVE FORMER



Used to form a cove where floor coverings are continued up the wall. Usually used with a capping seal or cap to finish the raw edge of the floor covering.
Delivery: 25 units of 21m per box

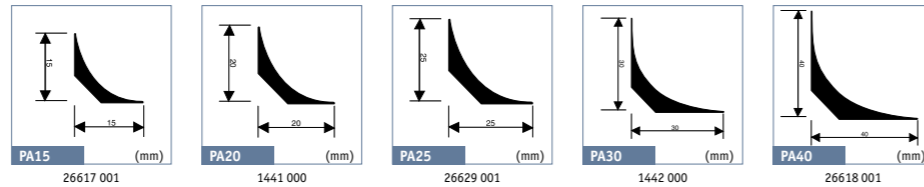

■ PVC CAPPING



Used to finish the top of a resilient floor covering where it has been covered up the wall. Usually used with a cove former.
CAP1: semi-flexible, cost-effective
CAP2: self-adhesive, easy to install
CAP3: two-parted, hygienic

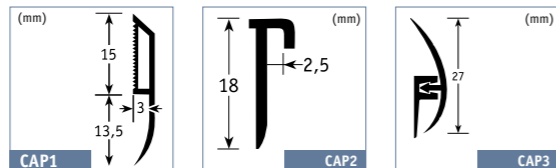

	CAP1	CAP2	CAP3
Medium grey RAL: 5000 NCS: S 5502 B	1443 000	-	-
Light grey RAL: 7500 NCS: S 3000 N	1443 001	-	-
White RAL: 9003 NCS: S 0500 N	1443 002	1444 001	1445 001
Black RAL: 1500 NCS: S 9000 N	-	1444 000	1445 000
Silver	-	1444 002	-
Wood colour matched RAL: 070 80 30 NCS: S 2020 Y 30 R	-	-	1445 002
Delivery	25 units in 21m per box	25 units of 2,70m per box	25 units of 2,70m per box

■ 2 IN 1: COVE FORMER & CAPPING

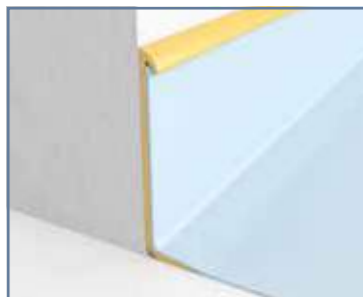

Provides a neat cove allowing floor coverings to be dressed up the wall to form a skirting, supports floor covering at a weak point, and protects the exposed edge.

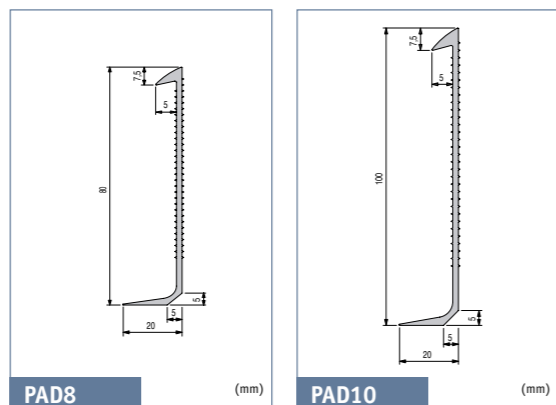

	PAD8	PAD10
Light grey RAL: 7500 NCS: S 3000 N	1438 001	1437 001
White RAL: 9003 NCS: S 0500 N	1438 002	1437 002
Delivery	20 units in 21m per box	20 units in 21m per box

SKIRTING ■ PREFORMED SET-IN SKIRTINGS

■ PREFORMED SKIRTING - PVC / LINO

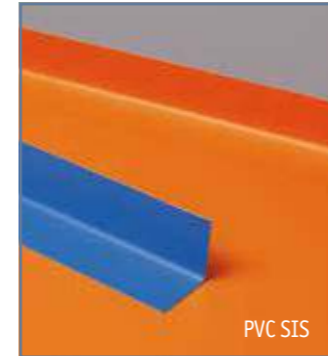

Preformed set-in skirting made of PVC or Linoleum flooring, reinforced with polymere on backside. Welded to the floor covering and glued to the wall. Ensure easy to clean and hygienic result.

PVC

60/80/100x100x2400mm, available upon request with all colours
 Ordering unit: 1 box of 10 pcs = 24lm (min order 2 boxes)

Art codes: **Acoustic** 100x100mm: 26611 ---
 100x80mm: 26612 ---
 100x60mm: 26613 ---
Compact 100x100mm: 26614 ---
 100x80mm: 26615 ---
 100x60mm: 26616 ---

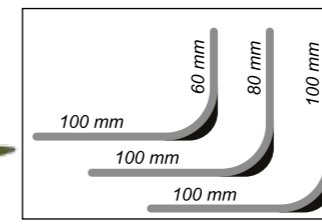
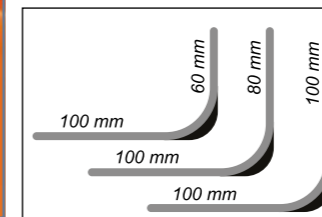

LINOLEUM

60/80/100x100x2400mm, available upon request with all colours
 Ordering unit: 1 box of 10 pcs = 48lm (min order 2 boxes)

	Compact 2mm	Compact 2.5mm	Acoustic 3.8mm
100x100mm:	1746	1743	1719
100x80mm:	1747	1744	1741
100x60mm:	1748	1745	1742

■ PREFORMED OUTER CORNER - PVC / LINO



Preformed outside corner made of PVC or Linoleum flooring, reinforced with polymere on backside. Welded to the floor covering and glued to the wall. Shock resistant & watertight.

PVC

Shock resistant & watertight outside corner made of Evolution flooring, Polymere reinforced structure.

To be glued or welded.

60/80/100x100x130mm, available upon request with all colours
 Ordering unit: 1 box of 10 pcs

Art codes: **Acoustic** 100x100mm: 26605 ---
 100x80mm: 26606 ---
 100x60mm: 26607 ---
Compact 100x100mm: 26608 ---
 100x80mm: 26609 ---
 100x60mm: 26610 ---

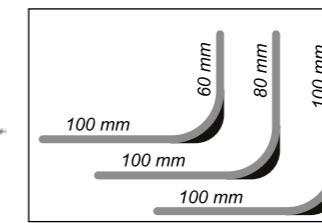
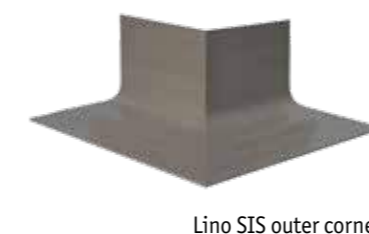
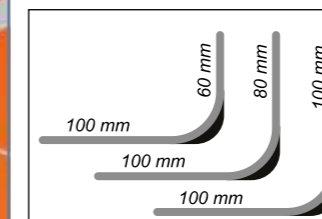

LINOLEUM

bar 60/80/100x100 - length 2400mm
 (size of the corner 130x130mm)

	Compact 2mm	Compact 2.5mm	Acoustic 3.8mm
100x100mm:	1766	1763	1760
100x80mm:	1767	1764	1761
100x60mm:	1768	1765	1762

Available also on 20 cm, onto the floor



ACCESSORIES FOR RESILIENT FLOORINGS

SKIRTING ■ DECORATIVE SET-ON SKIRTINGS

■ SEMI-FLEXIBLE DECORATIVE SKIRTING



KS61 - PVC semi-rigid skirting for decorative use.

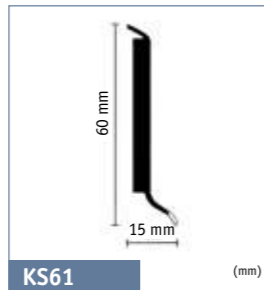

KS61	
White RAL: 9010 NCS: S 1002-Y	1411 002
Black RAL: 9004 NCS: S 8500 N	1411 007
Dark grey RAL: 7043 NCS: S 7500 N	1411 008
Medium grey RAL: 7012 NCS: S 6502 B	1411 009*
Grey RAL: 7004 NCS: S 4000 N	1411 010
Light grey RAL: 7500 NCS: S 3500 N	1411 011*
Very light grey RAL: 7035 NCS: S 2002 Y	1411 012*
Dark brown RAL: 060 40 05 NCS: S 7005 Y50 R	1411 013*
Dark red brown RAL: 050 20 16 NCS: S 8005 Y80 R	1411 014
Dark yellow brown RAL: 060 30 27 NCS: S 6020 Y30 R	1411 015
Red brown RAL: 8004 NCS: S 5040 Y60 R	1411 016
Terracotta RAL: 8002 NCS: S 6020 Y70 R	1411 017
Dark red RAL: 040 30 40 NCS: S 4050 Y90 R	1411 018*
Red RAL: 030 40 60 NCS: S 1080 Y90 R	1411 019
Orange RAL: 050 60 60 NCS: S 0580 Y50 R	1411 020
Beige RAL: 070 60 20 NCS: S 4020 Y20 R	1411 021
Medium brown RAL: 060 40 30 NCS: S 5030 Y50 R	1411 022
Brown RAL: 060 50 30 NCS: S 4030 Y40 R	1411 023
Light brown RAL: 060 60 30 NCS: S 3040 Y40 R	1411 024
Medium beige RAL: 070 80 30 NCS: S 2020 Y30 R	1411 025

KS61	
Grege RAL: 070 80 10 NCS: S 2005 Y40 R	1411 026
Light beige RAL: 080 80 20 NCS: S 2010 Y20 R	1411 027
Yellow RAL: 070 70 60 NCS: S 1070 Y20 R	1411 028
Purple red RAL: 340 50 20 NCS: S 5020 R30 B	1411 029
Purple blue RAL: 290 60 25 NCS: S 2030 R60 B	1411 030
Light purple RAL: 290 60 10 NCS: S 3020 R60 B	1411 031
Rose wood RAL: 060 60 10 NCS: S 3010 Y50 R	1411 032
Light green RAL: 120 70 30 NCS: S 2030 G40 Y	1411 033
Medium green RAL: 110 60 20 NCS: S 3020 G40 Y	1411 034
Blue green RAL: 190 60 10 NCS: S 3010 B70 G	1411 035
Green yellow RAL: 100 70 60 NCS: S 2050 G70 Y	1411 036
Night blue RAL: 250 30 10 NCS: S 7010 R90 B	1411 037*
Navy blue RAL: 250 50 25 NCS: S 3040 R90 B	1411 038
Dark blue RAL: 270 40 25 NCS: S 5030 R80 B	1411 039
Blue RAL: 260 60 25 NCS: S 2040 R80 B	1411 040
Medium blue RAL: 250 50 20 NCS: S 4030 R90 B	1411 041
Sky blue RAL: 230 70 15 NCS: S 2020 B	1411 042
Light blue RAL: 260 70 15 NCS: S 2020 R90 B	1411 043
Green blue RAL: 200 60 20 NCS: S 3030 G50 Y	1411 044

Delivery 20 units of 2.50lm

* 4 colours available in self adhesive skirtings.

Medium grey 1461 009
Light grey 1461 011
Very light grey 1461 012
Dark brown 1461 013

SKIRTING ■ DECORATIVE SET-ON SKIRTINGS

■ RIGID DECORATIVE SKIRTING WITH MATERIAL TO BE INSERTED



IS60/ISS60 - Rigid skirtings made on MDF support.
Floor covering to be inserted for perfect colour matching. To be glued.
ISS60 - Specially developed for LVT.

IS60	
Medium grey RAL: 5000 NCS: S 5502 B	1448 000
Light grey RAL: 7500 NCS: S 3000 N	1448 001
White RAL: 9003 NCS: S 0500 N	1448 002

ISS60	
black NCS: S8500-N	1462 001
silver grey RAL: 7035 NCS: S2002-B	1462 002
white RAL: 9003 NCS: S0502-B	1462 003
chocolate NCS: S8010-Y70R	1462 004
light beige NCS: S2030-Y30R	1462 005
cappuccino NCS: S5020-Y30R	1462 006

Delivery 20 units of 2.57lm

Delivery 20 pieces in one cardboard box = 51.40lm

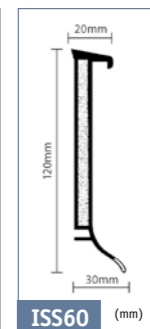
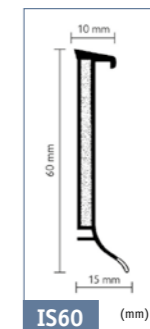

■ FLEXIBLE DECORATIVE SKIRTING WITH MATERIAL TO BE INSERTED



Very flexible skirting for curved walls and pillars. Floor covering to be inserted for perfect colour matching. Self adhesive both sides: 7 x 60 x 2 500mm.

Ordering unit: 1 box of 10 = 25lm.

ISF 60	
White RAL: 9016 NCS: S0300-N	1463 007
Silver grey RAL: 7004 NCS: S4000-N	1463 002
Steel NCS: S4500-N	1463 003



ACCESSORIES FOR RESILIENT FLOORINGS

SKIRTING ■ SET-ON SKIRTINGS

■ FLEXIBLE SKIRTING



Flexible PVC skirting used where a neat and clean finishing is required in non critical areas.

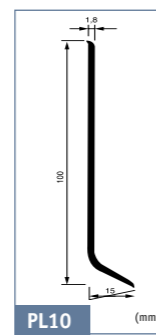
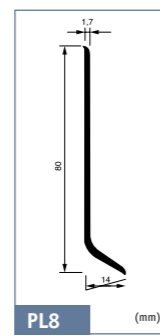
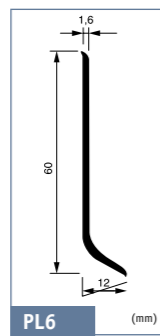

	PL6	PL8	PL10
Matched to wood RAL: 070 80 30 NCS: S 2020 Y 30 R	1449 000	1458 000	1450 000
Black RAL: 1500 NCS: S 9000 N	1449 001	1458 001	1450 001
Medium grey RAL: 5000 NCS: S 5502 B	1449 002	1458 002	1450 002
Silver grey RAL: 070 80 30 NCS: S 2005 Y 40 R	1449 003	1458 003	1450 003
Light grey RAL: 8500	1449 004	1458 004	1450 004
White RAL: 9003 NCS: S 0500 N	1449 005	1458 005	1450 005
Delivery	1 unit of 500m per box	1 unit of 500m per box	1 unit of 500m per box

■ VENTILATED SKIRTING

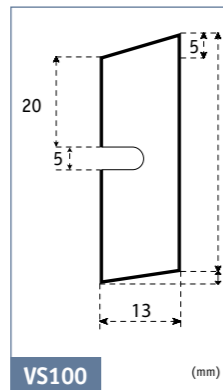
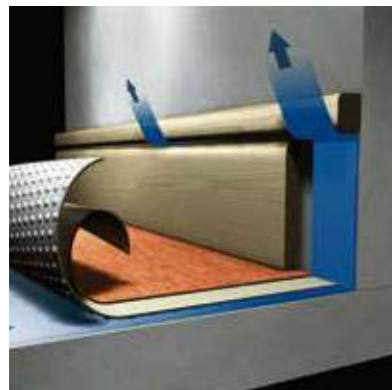

Ventilated skirting made of wood to be painted. To be used in combination with loose lay floorings or with floor coverings on Tarkolay.
Article code: 1252 030 (unfinished)

COVING ■ CAPPINGS FOR LVT

■ LVT SKIRTING CAP



Aluminium skirting cap for LVT Click & Loose-Lay to be combined with skirting bottom.

- To be glued.
- Perfect protection of the edge of the product
- Elegant finish

Size: 20 mm wide x 6 mm high inside x 8.5 mm high outside x 2500 mm long

Packaging: 10 units of 2,5m in a cardboard box ie 25 lm

Article code: 26626 011: silver
26626 012: stainless steel

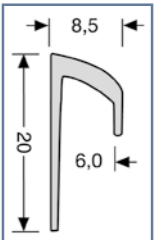

Silver	26626 011
Stainless steel	26626 012

■ LVT SKIRTING BOTTOM

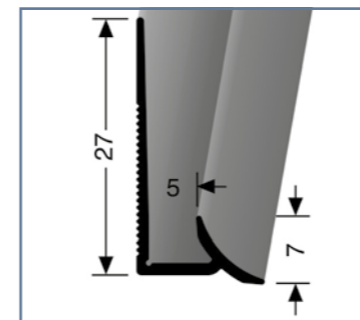

Aluminium skirting bottom for LVT Click & Loose-Lay, to be combined with the cap for skirting. To be glued.

- Real material to be inserted
- Elegant finish with 100 % color matching with floor covering
- Also compatible for perfect finish in stairs

Size: 5 mm inside x 27 mm high x 7 mm lower lip x 2500 mm long

Packaging: 10 units of 2,5m in a cardboard box = 25 lm

Article code: 26626 021: silver
26626 022: stainless steel

Silver	26626 021
Stainless steel	26626 022

SPECIAL STRIPS ■ DECORATIVE STRIPS FOR LVT

■ LVT FEATURE STRIPS



Create visual effects with contrasts of colour - to highlight interior features, shape perceptions of room size or personalise your flooring design in plank or tile arrangements.

BLACK	1421 001
SILVER	1421 002
GOLD	1421 003
COPPER	1421 012
EGGSHELL	1421 013
TAUPE	1421 007
DARK GREY	1421 009
ROYAL BLUE	1421 011
RED	1421 010



ACCESSORIES FOR RESILIENT FLOORINGS

SKIRTING ■ DECORATIVE SET-ON SKIRTINGS FOR LVT

■ LVT PVC SKIRTING



- compact PVC skirting with decorative film and **PUR treatment**, to be glued
- **easy maintenance** with water-resistant material
- perfect finishing with **matching colours** for:
 - all references of **iD Inspiration 55/70 & 40**
 - all references of **iD Inspiration Loose-lay**
 - **TILT** Concrete references
 - 22 references of **iD Essential**

Size: 60 mm high x 10 mm thick x 2020 mm long

Packaging: 10 pieces in one box = 20,20 lm

iD Inspiration Loose-lay			
LVT Design	LVT Colour	LVT Colour reference (3 last digits)	Skirting reference NEW (10 units)
BEACH WOOD	BEIGE	009	26640 753
BEACH WOOD	GREY	010	26640 754
BÉTON	WHITE	000	26640 740
BÉTON	GREY	002	26640 739
BÉTON	BLACK	001	26640 741
CHRISTMAS PINE	BROWN	008	26640 744
CHRISTMAS PINE	WHITE	006	26640 746
CHRISTMAS PINE	NATURAL	007	26640 745
DELICATE WOOD	BLACK	013	26640 759
DELICATE WOOD	WHITE	011	26640 758
DELICATE WOOD	GREGE	012	26640 760
ELEGANT OAK	BEIGE	014	26640 743
ELEGANT OAK	NATURAL	015	26640 742
LIMED OAK	BEIGE	000	26640 750
LIMED OAK	GREY	001	26640 751
LIMED OAK	BROWN	002	26640 752
MOUNTAIN OAK	NATURAL	003	26640 749
MOUNTAIN OAK	BROWN	004	26640 748
MOUNTAIN OAK	BLACK	005	26640 747
SAWN OAK	GREY	016	26640 755
SAWN OAK	BROWN	017	26640 756
SAWN OAK	DARK BROWN	018	26640 757

iD Essential 30			
LVT Design	LVT Colour	LVT Colour reference (3 last digits)	Skirting reference
CERUSED OAK	BEIGE	24707 009	24640 207
CERUSED OAK	LIGHT BROWN	24707 010	24640 209
CERUSED OAK	BROWN	24707 011	24640 208
COUNTRY OAK	BEIGE	24707 001	24640 238
COUNTRY OAK	NATURAL	24707 002	24640 237
COUNTRY OAK	GREY	24707 003	24640 236
SMOKED OAK	BROWN	3977 001	24640 212
SMOKED OAK	DARK GREY	3977 003	24640 211
SMOKED OAK	LIGHT GREY	3977 004	24640 210
SOFT OAK	NATURAL	3977 008	24640 215
SOFT OAK	BEIGE	3977 009	24640 217
SOFT OAK	LIGHT GREY	3977 010	24640 219
SOFT OAK	LIGHT BROWN	3977 012	24640 218
SOFT OAK	LIGHT BEIGE	3977 015	24640 216
VENEZIA	GREY	3979 001	24640 224
WASHED PINE	WHITE	24707 004	24640 206
WASHED PINE	BEIGE	24707 005	24640 204
WASHED PINE	LIGHT BROWN	24707 006	24640 205
WASHED PINE	SNOW	24707 007	24640 202
WASHED PINE	BLUE	24707 008	24640 203

iD Essential Click			
LVT Design	LVT Colour	LVT Colour reference (3 last digits)	Skirting reference
DELICATE OAK	NATURAL	24722 002	26640 215
LIMEWASHED OAK	BEIGE	24722 000	26640 207
LIMEWASHED OAK	BROWN	24722 001	26640 208
RUST METAL	BROWN	24722 001	26640 227
RUST METAL	BLACK	24722 002	26640 226
STONE	GREY	24723 000	26640 224
TOASTED OAK	LIGHT GREY	24722 003	26640 210
TOASTED OAK	DARK GREY	24722 004	26640 211

iD Inspiration Click			
LVT Design	LVT Colour	LVT Colour reference (3 last digits)	Skirting reference
CONTEMPORARY OAK	GREY	109	26640 346
CONTEMPORARY OAK	GREGE	110	26640 347
CONTEMPORARY OAK	NATURAL	111	26640 348
CONTEMPORARY OAK	BROWN	112	26640 349
ELM	LIGHT GREY	113	26640 350
ELM	BEIGE	114	26640 351
ELM	NATURAL	115	26640 352
OXIDE	COPPER	118	26640 359
OXIDE	STEEL	119	26640 360
OXIDE	BLACK STEEL	120	26640 361
PATINA ASH	BEIGE	106	26640 343
PATINA ASH	BROWN	107	26640 344
PATINA ASH	GREY	108	26640 345
RUSTIC OAK	STONE BROWN	121	26640 370
RUSTIC OAK	DARK GREY	122	26640 371
RUSTIC OAK	MEDIUM GREY	123	26640 372
RUSTIC OAK	LIGHT GREY	124	26640 373
RUSTIC OAK	NATURAL	125	26640 374
RUSTIC OAK	BEIGE	126	26640 375
RUSTIC OAK	BROWN	127	26640 376
RUSTIC OAK	MEDIUM BROWN	128	26640 377
RUSTIC SLATE	BLACK	069	26640 274
RUSTIC SLATE	BEIGE	070	26640 275
RUSTIC SLATE	GREY	071	26640 276
SCANDINAVIAN OAK	LIGHT BEIGE	100	26640 333
SCANDINAVIAN OAK	MEDIUM BEIGE	101	26640 334
SCANDINAVIAN OAK	DARK BEIGE	102	26640 335
SCANDINAVIAN OAK	LIGHT GREY	103	26640 336
SCANDINAVIAN OAK	MEDIUM GREY	104	26640 337
SCANDINAVIAN OAK	DARK GREY	105	26640 338
TERRAZZO	GREY	129	26640 378
TERRAZZO	GREEN	130	26640 379
TERRAZZO	ANTHRACITE	131	26640 380
TISSE	BEIGE	082	26640 277
TISSE	BLACK	083	26640 278
TISSE	LIGHT	084	26640 279
TISSE	BROWN	085	26640 280
TISSE	RED	086	26640 281
TISSE	BLUE	087	26640 282
TISSE	GREEN	091	26640 283
TREND LINE	BLACK	088	26640 284
TREND LINE	INTERFERENTIAL	089	26640 285
TREND LINE	SILVER	090	26640 286
TWINE	LIGHT GREY	038	26640 362
TWINE	MEDIUM GREY	039	26640 363
TWINE	DARK GREY	040	26640 364
TWINE	BLUE GREY	041	26640 365
TWINE	TURQUOISE	042	26640 366
TWINE	DENIM	043	26640 367
TWINE	INDIGO	044	26640 368
TWINE	PURPLE	045	26640 369
VINTAGE TEAK	GREY	092	26640 692
VINTAGE TEAK	NATURAL	093	26640 693
VINTAGE ZINC	BLACK	094	26640 287
VINTAGE ZINC	RUST	095	26640 288
VINTAGE ZINC	SILVER	096	26640 289
WENGE	BLACK	009	26640 290
WENGE	NATURAL	010	26640 291
WENGE	GREY	011	26640 292
WENGE	GREGE	012	26640 315

iD TILT	
Skirting colour	Skirting reference NEW (10 units)
WHITE	26640 700
ALUMINIUM	26640 701

iD Inspiration 55-70			
LVT Design	LVT Colour	LVT Colour reference (3 last digits)	Skirting reference NEW (10 units)
ANTIK OAK	BEIGE	001	26640 601
ANTIK OAK	BROWN	002	26640 602
ANTIK OAK	DARK GREY	003	26640 603
ANTIK OAK	GREY	004	26640 264
ANTIK OAK	NATURAL	005	26640 605
ANTIK OAK	LIGHT GREY	006	26640 261
ANTIK OAK	ANTHRACITE	007	26640 262
ANTIK OAK	MIDDLE GREY	008	26640 263
BARDIGLIO	LIME STONE	034	26640 355
BARDIGLIO	GREY	035	26640 356
BARDIGLIO	DARK GREY	036	26640 357
BARDIGLIO	ANTHRACITE	037	26640 358
BRUSHED PINE	BROWN	013	26640 613
BRUSHED PINE	GREY	014	26640 614
BRUSHED PINE	NATURAL	015	26640 265
BRUSHED PINE	WHITE	016	26640 266
CAVIAR	MISTY GREY	017	26640 326
CAVIAR	TOBACCO	018	26640 327
CAVIAR	GREY	019	26640 328
CAVIAR	BROWN	020	26640 329
CAVIAR	MAUVE	021	26640 330
CAVIAR	BEIGE	022	26640 331
CAVIAR	FOGGY BLUE	023	26640 332
COMPOSITE	WARM GREY	072	26640 316
COMPOSITE	COOL GREY	073	26640 317
COMPOSITE	BLACK	074	26640 318
CONTEMPORARY OAK	GREY	109	26640 346
CONTEMPORARY OAK	GREGE	110	26640 347
CONTEMPORARY OAK	NATURAL	111	26640 348
CONTEMPORARY OAK	BROWN	112	26640 349
ELM	LIGHT GREY	113	26640 350
ELM	BEIGE	114	26640 351
ELM	NATURAL	115	26640 352
ELM	GREGE	116	26640 353
ELM	BROWN	117	26640 354
ENGLISH OAK	BEIGE	024	26640 624
ENGLISH OAK	BROWN	025	26640 625
ENGLISH OAK	LIGHT	026	26640 626
ENGLISH OAK	NATURAL	027	26640 627
ENGLISH OAK	LIGHT BEIGE	028	26640 627
ENGLISH OAK	GREY BEIGE	029	26640 268
METAL FRAME	ROSE	078	26640 322
METAL FRAME	PLATINUM	079	26640 323
METAL FRAME	ALUMINIUM	080	26640 324
METAL FRAME	STAINLESS	081	26640 325
OXIDE	COPPER	118	26640 359
OXIDE	STEEL	119	26640 360
OXIDE	BLACK STEEL	120	26640 361
PALLET PINE	WHITE	030	26640 339
PALLET PINE	BEIGE	031	26640 340
PALLET PINE	NATURAL	032	26640 341
PALLET PINE	BROWN	033	26640 342
PATINA ASH	BEIGE	106	26640 343
PATINA ASH	BROWN	107	26640 344
PATINA ASH	GREY	108	26640 345
POLISHED CONCRETE	LIGHT GREY	075	26640 319
POLISHED CONCRETE	MEDIUM GREY	076	26640 320
POLISHED CONCRETE	DARK GREY	077	26640 321
ROCK	BEIGE	062	26640 269
ROCK	BLACK	063	26640 270
ROCK	BROWN	064	26640 271
ROCK	GREGE	065	26640 272
ROCK	GREY	066	26640 273
RUSTIC OAK	STONE BROWN	121	26640 370
RUSTIC OAK	DARK GREY	122	26640 371
RUSTIC OAK	MEDIUM GREY	123	26640 372
RUSTIC OAK	LIGHT GREY	124	26640 373
RUSTIC OAK	NATURAL	125	26640 374
RUSTIC OAK	BEIGE	126	26640 375
RUSTIC OAK	BROWN	127	26640 376
RUSTIC OAK	MEDIUM BROWN	128	26640 377
RUSTIC SLATE	BLACK	069	26640 274
RUSTIC SLATE	BEIGE	070	26640 275
RUSTIC SLATE	GREY	071	26640 276
SCANDINAVIAN OAK	LIGHT BEIGE	100	26640 333
SCANDINAVIAN OAK	MEDIUM BEIGE	101	26640 334
SCANDINAVIAN OAK	DARK BEIGE	102	26640 335
SCANDINAVIAN OAK	LIGHT GREY	103	26640 336
SCANDINAVIAN OAK	MEDIUM GREY	104	26640 337
SCANDINAVIAN OAK	DARK GREY	105	26640 338
TERRAZZO	GREY	129	26640 378
TERRAZZO	GREEN	130	26640 379
TERRAZZO	ANTHRACITE	131	26640 380
TISSE	BEIGE	082	26640 277
TISSE	BLACK	083	26640 278
TISSE	LIGHT	084	26640 279
TISSE	BROWN	085	26640 280
TISSE	RED	086	26640 281
TISSE	BLUE	087	26640 282
TISSE	GREEN	091	26640 283
TREND LINE	BLACK	088	26640 284
TREND LINE	INTERFERENTIAL	089	26640 285
TREND LINE	SILVER	090	26640 286
TWINE	LIGHT GREY	038	26640 362
TWINE	MEDIUM GREY	039	26640 363
TWINE	DARK GREY	040	26640 364
TWINE	BLUE GREY	041	26640 365
TWINE	TURQUOISE	042	26640 366
TWINE	DENIM	043	26640 367
TWINE	INDIGO	044	26640 368
TWINE	PURPLE	045	26640 369
VINTAGE TEAK	GREY	092	26640 692
VINTAGE TEAK	NATURAL	093	26640 693
VINTAGE ZINC	BLACK	094	26640 287
VINTAGE ZINC	RUST	095	26640 288
VINTAGE ZINC	SILVER	096	26640 289
WENGE	BLACK	009	26640 290
WENGE	NATURAL	010	26640 291
WENGE	GREY	011	26640 292
WENGE	GREGE	012	26640 315

iD Inspiration 40			
LVT Design	LVT Colour	LVT Colour reference (3 last digits)	Skirting reference
ANTIK OAK	LIGHT BROWN	132	26640 381
ANTIK OAK	WHITE	133	26640 382
ANTIK OAK	GREGE	134	26640 383
ANTIK OAK	CLASSICAL	135	26640 384
ANTIK OAK	DARK BROWN	136	26640 385
BRUSHED PINE	WHITE	016	26640 266
BRUSHED PINE	NATURAL GREY	137	26640 387
BRUSHED PINE	LIGHT BROWN	138	26640 388
ENGLISH OAK	GREGE	139	26640 389
ENGLISH OAK	DARK BROWN	140	26640 390
ENGLISH OAK	CLASSICAL	141	26640 391
LARGE BEECH	NATURAL	142	26640 392
MAPLE	STUDIO	143	26640 393
MODERN OAK	WHITE	144	26640 394
MODERN OAK	BEIGE	145	26640 395
MODERN OAK	CLASSICAL	146	26640 396
PATINA ASH	BEIGE	106	26640 343
PATINA ASH	BROWN	107	26640 344
PATINA ASH	GREY	108	26640 345
POLISHED CONCRETE	LIGHT GREY	075	26640 319
POLISHED CONCRETE	MEDIUM GREY	076	26640 320
POLISHED CONCRETE	DARK GREY	077	26640 321
ROCK	GREY	066	26640 273
ROCK	NATURAL GREY	147	26640 398
RUSTIC OAK	MEDIUM GREY	123	26640 372
RUSTIC OAK	LIGHT GREY	124	26640 373
RUSTIC OAK	BROWN	127	26640 376
RUSTIC OAK	NATURAL	127	26640 374
SOFT WALNUT	RED BROWN	147	26640 399
SOFT WALNUT	CLASSICAL	149	26640 400
VINTAGE ZINC	ALU	150	26640 401
WHITE OAK	LIGHT	151	26640 402
WHITE OAK	GREY		

ACCESSORIES FOR RESILIENT FLOORINGS

TRANSITION PROFILES ■ PVC PROFILES FOR ROLLS

■ TRANSITION PROFILE



One piece vinyl transition strip used to join different floorings of the same or slightly different heights. To be glued.

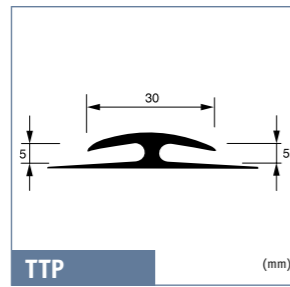

TTP	
Dark grey RAL: 5000 NCS: S 5502 B	1452 000
Light grey RAL: 7500 NCS: S 3000 N	1452 001
White RAL: 9003 NCS: S 0500 N	1452 002
Delivery	2 units of 25lm

■ ALUMINIUM TRANSITION PROFILE



Aluminium transition strip used to join different flooring materials. Suitable for use in heavy traffic environments. To be screwed. Typically used at door thresholds.

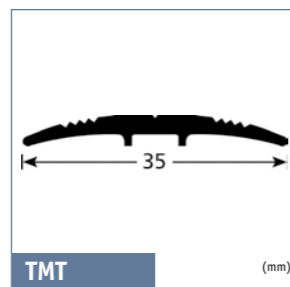

TMT	
Silver	1451 000
Bronze	1451 001
Delivery	10 units of 2.70lm

TRANSITION PROFILES ■ ALUMINIUM PROFILES FOR LVT

■ LVT TRANSITION STRIP VERY HIGH TRAFFIC

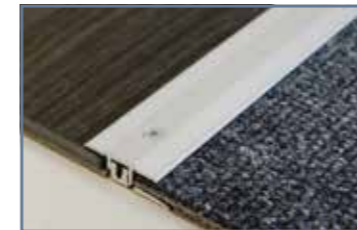

Aluminium transition strip for LVT Click & Loose-Lay in very high traffic.

- To be screwed.
- Very resistant to very high traffic & rolling loads.
- Ribbed surface for slip-resistance.

Size: 25 mm wide x 4/9.5 mm high x 2700 mm long

Packaging: Full kit including Bottom & Top profiles with screws: 10 units of 2,7lm in a cardboard box = 27 lm



Silver NCS:S 2500-N	1451 011
Stainless steel NCS:S 6005-Y20R	1451 012

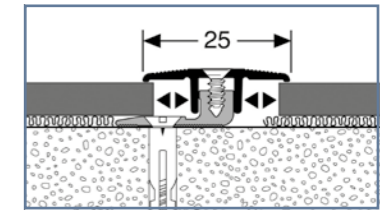

■ LVT TRANSITION STRIP GENERAL TRAFFIC



Aluminium transition strip for LVT Click & Loose-Lay used in general traffic areas.

- To be screwed.
- Elegant finish with smooth surface and no visual screws.
- Bendable with radius 60 cm.

Size: 24 mm wide x 6 mm high x 2700 mm long

Packaging: Full kit including top profiles and dowls. 10 units of 2,7lm in a cardboard box = 27 lm



Silver NCS:S 2500-N	1451 021
Stainless steel NCS:S 6005-Y20R	1451 022

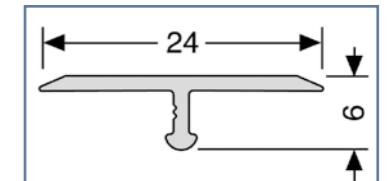

ACCESSORIES FOR RESILIENT FLOORINGS

TRANSITION PROFILES ■ STOP PROFILES FOR ROLLS

■ FLEXIBLE RAMP PROFILE



Bendable aluminium profiles used to form a joint between different types of floor coverings. Can be manually curved on site to accommodate shaped and radius designs. Two heights available: one for compact floors (FT 2.5) and one for acoustic floors (FT 5). To be glued.

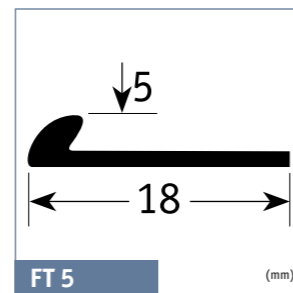
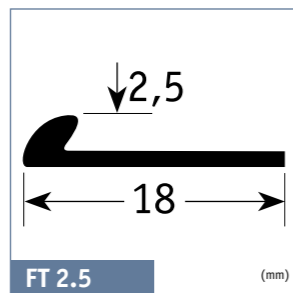

Silver	FT 2.5mm	FT 5.0mm
	1456 000	1456 001
Delivery	10 units of 2.5lm	10 units of 2.5lm

TRANSITION PROFILES ■ STOP PROFILES FOR LVT

■ LVT BENDABLE STOP PROFILE



Aluminium stop profile to be screwed.

- Very resistant to wear & traffic
- Ribbed surface for slip-resistance
- Bendable with radius 80cm

Size: 30 mm wide x 5 mm high inside x 8 mm high outside 30 mm high x 2500 mm long
Packaging: Full kit including stop profiles, screws and dowels. 10 units of 2,5lm in a cardboard box = 25 lm

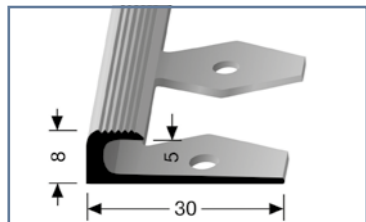

Silver	NCS:S 2500-N	1456 011
Stainless steel	NCS:S 6005-Y20R	1456 012

TRANSITION PROFILES ■ RAMPS FOR ROLLS

■ METALLIC RAMP PROFILE



Metallic floor trim providing a neat and simple solution to join floor coverings with medium difference in thickness. To be screwed.

- RP2: compatible with acoustic floorings

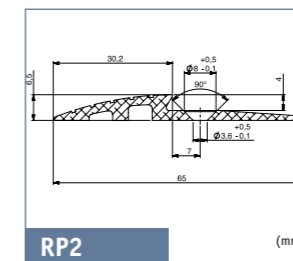

Silver	RP2
	1454 001
Delivery	10 units of 3lm

■ METALLIC RAMP PROFILE



Metallic floor trim providing a neat and simple solution to join floor coverings with major difference in thickness. To be screwed. Compatible with Omnisports floorings and carpet.

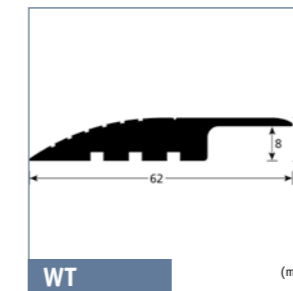

Silver	WT
	1455 000
Delivery	5 units of 3lm

TRANSITION PROFILES ■ RAMPS FOR LVT

■ LVT RAMP PROFILE VERY HIGH TRAFFIC



Aluminium transition strip for LVT Click & Loose-Lay used in very heavy traffic areas.

- To be screwed.
- Very resistant to very high traffic & rolling loads – with long ramp to ease transfers.
- Ribbed surface for slip-resistance.

Size: 38 mm wide x 5/7 mm high x 2700 mm long
Packaging: Kit including ramp profile and screws. 10 units of 2,7lm in a cardboard box = 27 lm



Silver	NCS:S 2500-N	1454 011
Stainless steel	NCS:S 6005-Y20R	1454 012

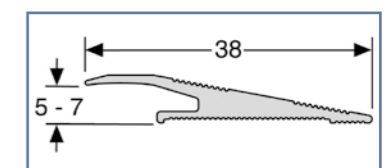

ACCESSORIES FOR RESILIENT FLOORINGS

STAIRS ■ STAIR NOSINGS FOR ROLLS

■ PVC STAIRNOSE



Flexible PVC stairnose. Cut to size on site and fixed with adhesive before floor covering. Typically used with resilient floor coverings.

- NM1:** specially designed for round-shaped stair noses, with bending radius 8R.
- NM20:** designed for slight round-shaped stair noses in housing, with bending radius 4R.
- NM45:** designed for sharp-angled stair noses, with bending radius 2R, for stairs over 16cm high.

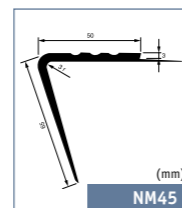
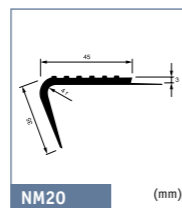
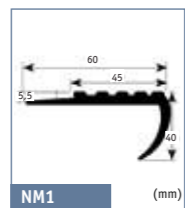

	NM1	NM20	NM45
Black RAL: 9004 NCS: S 8500 N	1401 004	1404 004	1403 004
Medium grey RAL: 7012 NCS: S 6500 N	1401 005	1404 005	1403 005
Light grey RAL: 7040 NCS: S 2500 N	1401 006	1404 006	1403 006
Silver grey RAL: 9002 NCS: S 1502 N	1401 007	1404 007	1403 007
Delivery	12 units of 3m	12 units of 3m	12 units of 3m

■ ALUMINIUM STAIRNOSE



Aluminium stairnose. To be screwed over the floor covering.

MS1	
Silver	1434 001
Delivery	10 units of 2.6m

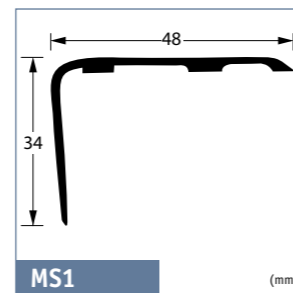

STAIRS ■ STAIR NOSINGS FOR LVT

■ LVT CLICK & LOOSE-LAY STAIRNOSE HIGH TRAFFIC



- Aluminium stairnose to be screwed. Very resistant to wear & traffic
- Ribbed surface for slip-resistance
- Elegant finish

Size: 40 mm wide x 5 mm inside x 2500 mm long
Packaging: Full kit including stairnose profile, screws and dowls. 10 units of 2,5m in a cardboard box = 25lm

Silver NCS:S 2500-N	1434 021	Stainless steel NCS:S 6005-Y20R	1434 022
-------------------------------	----------	---	----------

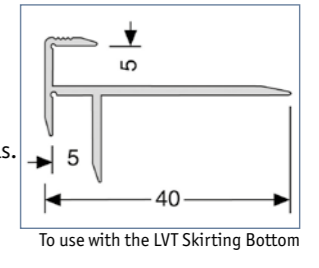

To use with the LVT Skirting Bottom

■ LVT CLICK & LOOSE-LAY STAIRNOSE VERY HIGH TRAFFIC



- Aluminium stairnose for LVT used in very high traffic areas. To be screwed.
- Very resistant to very high traffic
- Ribbed surface for slip-resistance

Size: 38 mm wide x 5/5.5 mm inside x 30 mm high x 2500 mm long
Packaging: Full kit including stairnose profiles, screws and dowls. 5 units of 2,5m in a cardboard box = 12.5 lm

Silver NCS:S 2500-N	1434 011	Stainless steel NCS:S 6005-Y20R	1434 012
-------------------------------	----------	---	----------

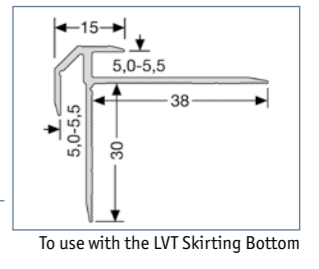

To use with the LVT Skirting Bottom

STAIRS ■ STAIR CORNERS

■ INSIDE & OUTSIDE STAIR CORNER



Corners designed to form a neat and attractive edge around the open end of a step by concealing the edge of the floor covering and stair edging. Colour combination with PVC stair nosing.

- SB1:** used to protect the bottom of the wall alongside the staircase
- SB2:** used to protect the edge of the floor covering and to hide it

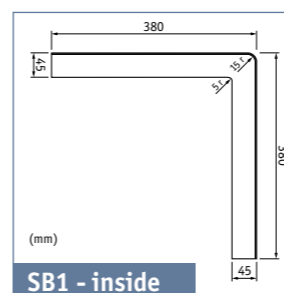

SB1 - inside

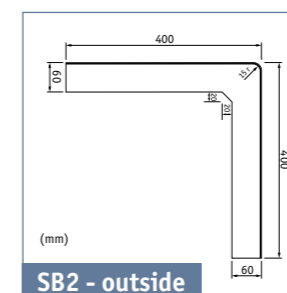

SB2 - outside

	SB1 interior	SB2 exterior
Black RAL: 9004 NCS: S 8500 N	1432 004	1433 004
Medium grey RAL: 7012 NCS: S 6500 N	1432 005	1433 005
Light grey RAL: 7040 NCS: S 2500 N	1432 006	1433 006
Silver grey RAL: 9002 NCS: S 2500 N	1432 007	1433 007
Delivery	20 units per box	20 units per box



ACCESSORIES FOR RESILIENT FLOORINGS

ACCESSIBILITY ■ SAFETY & GUIDANCE

■ WARNING TILE – TO BE GLUED

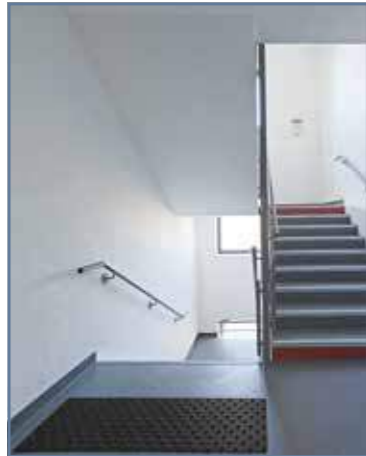

Helps recognize a change in level, in accordance with regulatory requirements for disabled access and safety. Various formats available. Self-adhesive or to be glued to the floorcovering (according to product).

Rectangular tiles (to be glued)
Format: 800 x 420 x 7mm
Ordering unit: 1 box of 6 tiles



WS1		
White	RAL: 9010 NCS: S 0500 N	1431 001
Black	RAL: 9004 NCS: S 8500 N	1431 002
Light grey	RAL: 7035 NCS: S 2002 G	1431 003

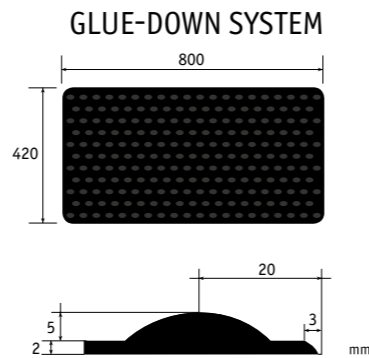

■ WARNING TILE – SELF-ADHESIVE

	Self-adhesive	
	Rectangular tile	Square tile
White	1440 350	1440 450
Grey	1440 351	1440 451
Black	1440 352	1440 452
Ivory	1440 353	1440 453
Red	1440 354	1440 454
Yellow	1440 355	1440 455

Self-adhesive rectangular tiles
Format: 815 x 420 x 8mm
Ordering unit: 1 box of 10 tiles

Self-adhesive square tiles
Format: 450 x 420 x 8mm
Ordering unit: 1 box of 10 tiles

SELF-ADHESIVE RECTANGULAR TILE

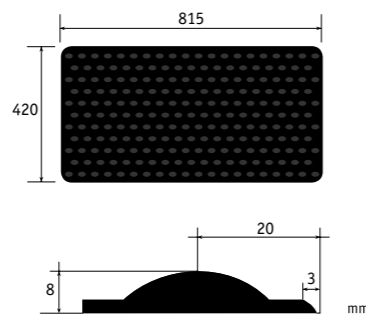

SELF-ADHESIVE SQUARE TILE

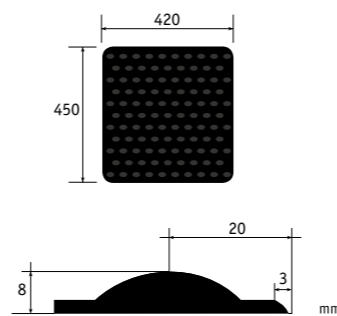

ACCESSIBILITY ■ SAFETY & GUIDANCE

■ EASY KIT 3D STUDS

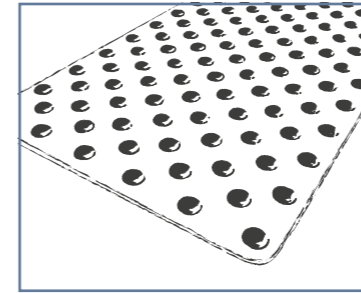

Ready to use self-adhesive warning studs kits for heavy traffic. Kit of 33 studs already pre-mounted in template, allowing the simultaneous installation of 33 studs. Easy, effective and reliable installation.

Format: 42cm
Width: 22,5cm
Height: 5mm
Net weight: 0,13kg
Type kit of 33 studs

Packaging
Pieces per box: 8 kits
Box size: 44x27x7cm
Box weight: 1kg

Grey	1440551
Black	1440552

■ TACTILE STRIPS



Designed for visually impaired people to help finding their way with blind stick. The strip should contrast in colour with the surrounding floor covering to ensure clear visibility.

Tactile strip (self-adhesive)
Available in rolls
Roll length: 15.24lm
Width: 30.48cm
Thickness: 1.6mm + studs 3.2mm

Linear strip: white stick follows channel (self-adhesive)
Available in tiles
Format: 600 x 150mm
Thickness: 2mm + studs 3mm

Tactile strip	Self adhesive	Linear strip
Snow White	1440 001	White
Charcoal	1440 020	Grey
Grey Haze	1440 024	Black
Black	1440 040	Ivory
Brown	144047	Red
		Yellow
Ordering unit	1 box of 1 roll = 15.24lm	Ordering unit
		1 box of 15 strips

SELF-ADHESIVE LINEAR STRIP

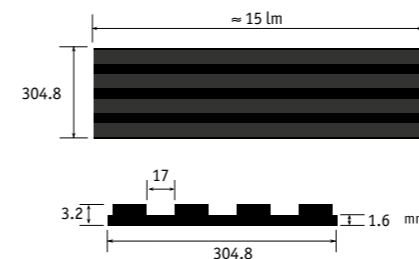

SELF-ADHESIVE STRIP IN ROLLS

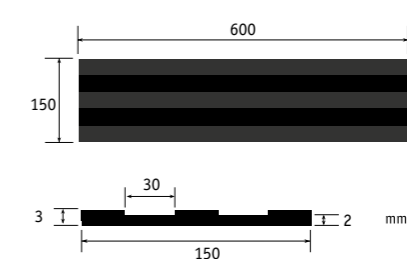

ACCESSORIES FOR RESILIENT FLOORINGS

WETROOM ■ DRAINS & GRATINGS

CLASSIC DRAINS

VERTICAL OUTLET Four models

SIPHON PURUS BRAGE 75
ref. 1416 005 outflow 0.8 L/s

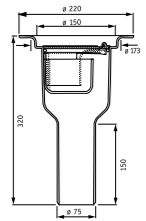

SIPHON PURUS BRAGE 50
ref. 1416 004 outflow 0.8 L/s

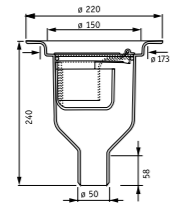

SIPHON STAINLESS STEEL 40*
ref. 1416 007 outflow 0.66 L/s



SIPHON PURUS DUSCH BRUNN 50
ref. 1416 001 outflow 0.8 L/s

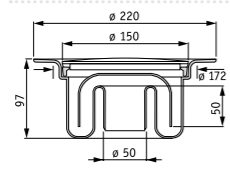

HORIZONTAL OUTLET Three models

SIPHON PURUS FREJA 50
ref. 1416 002 outflow 0.8 L/s

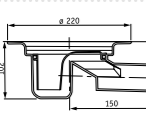

SIPHON PURUS ODEN 75
ref. 1416 003 outflow 0.8 L/s

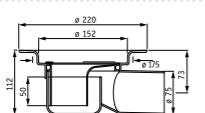

SIPHON MINIMAX
ref. 1416 006/ø50mm/outflow 0.8 L/s
ref. 1416 010/ø40mm/outflow 0.8 L/s

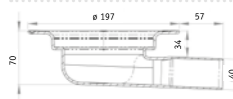

Special renovation

RECTANGULAR DRAINS



Dimensions
Length: 300, 600, 900mm
Width: 120mm
Height: 143*mm

* Note that the height depends on which gully you choose

TYPE AND DIMENSIONS				
		Length (mm)		
Gully type	Dim	300	600	900
 Side-/Side Side outlet (SO)	ø50 or ø75 H:	132	132	137
	ø50 A:	107	107	112
	ø75 A:	95	95	100
 Vertical outlet (VO)	ø50 H:	187	187	192
	ø75 H:	212	212	217
	ø50 A:	79	79	84
 Low side (LS)	ø50 H:	79	79	84
	ø50 A:	54	54	59

■ DRAINS

PVC and stainless steel drains and gratings, adapted to various conditions of use: outlet, height, diameter, and outflow.

GRATINGS



PURUS ITEMS

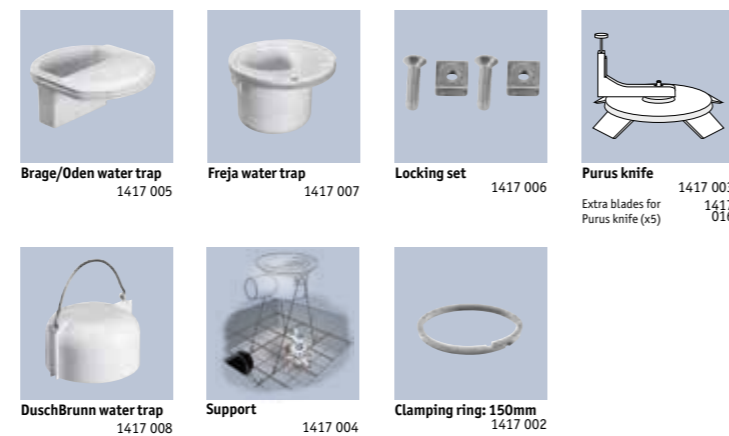

WETROOM ■ TRANSITIONS & JUNCTIONS

■ FLEXIBLE JUNCTION PROFILES



Flexible PVC junction profiles for wetrooms. Reduce thickness difference between floor rising to the wall and Aquarelle wall coverings.

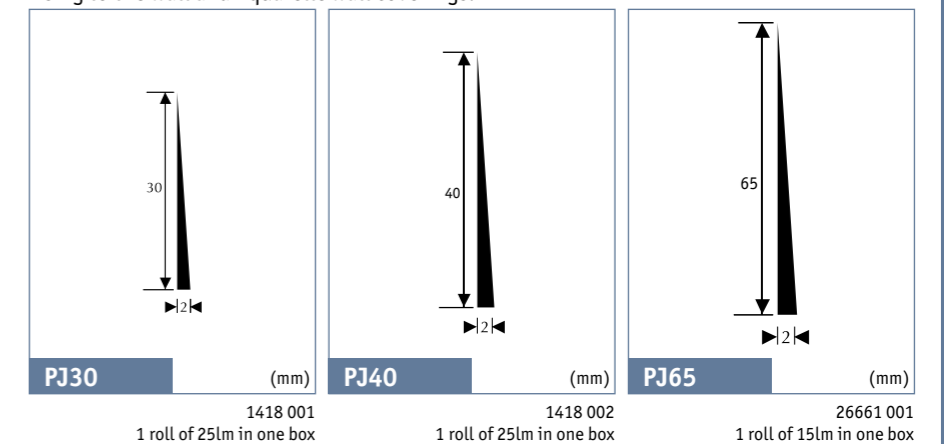

■ THRESHOLD TRANSITION FOR WETROOMS

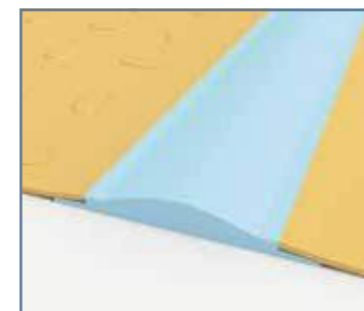

Rubber & PVC transition profiles for wetrooms.

RTS: Rubber. Flattens when doors opens
PTS: PVC. Hot weldable with flooring

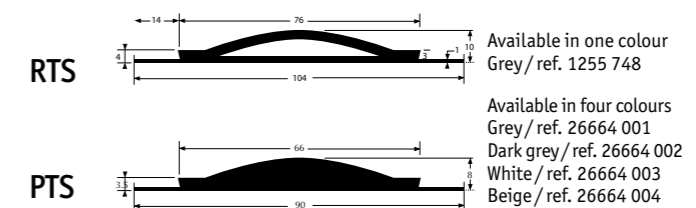

WETROOM ■ PIPE COLLARS

■ WATERPROOF PIPE COLLARS



Offer watertight finish for small diameter pipework in a variety of sizes.

STOSETT LOW TOPMEMBRANE		
Diameter*	Reference	Packaging
8 - 12mm	1420 001	24 sleeves + 12 clamps
11 - 15mm	1420 002	24 sleeves + 12 clamps
15 - 19mm	1420 003	24 sleeves + 12 clamps
18 - 22mm	1420 004	24 sleeves + 12 clamps
21 - 26mm	1420 005	24 sleeves + 12 clamps
26 - 31mm	1420 006	24 sleeves + 12 clamps
30 - 35mm	1420 007	24 sleeves + 12 clamps
35 - 42mm	1420 008	6 sleeves + 3 clamps
100 - 127mm	1420 009	1 sleeve
Adhesive for Stosett	1460 010	1 tube = 160ml

* The first figure indicates the diameter of the upper part; the second indicates the diameter at the groove.



ACCESSORIES FOR RESILIENT FLOORINGS

PROTECTWALL - CAPPINGS

■ CAPS

Aluminium and PVC caps (flexible and solid) to provide a perfect finish and protect the edge of the wall covering.

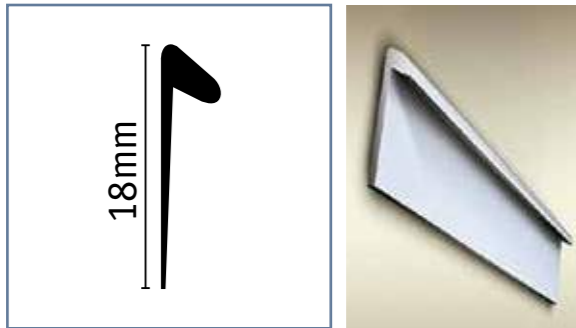

ALUMINIUM CAP 2.5

Self adhesive
3.5mm (ext.) x 2.5mm (int.) x
18mm x 2500mm

Delivery: 1 box of 10 pcs = 25lm

Silver NCS: S 2500-N	26621 001
Stainless steel NCS: S 6005-Y20R	26621 002

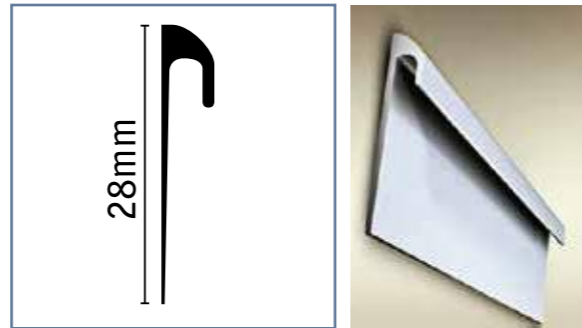

ALUMINIUM CAP 3

Self adhesive
5.2mm (ext.) x 3mm (int.) x
28mm x 2500mm

Delivery: 1 box of 10 pcs = 25lm

Silver NCS: S 2500-N	26626 001
Stainless steel NCS: S 6005-Y20R	26626 002

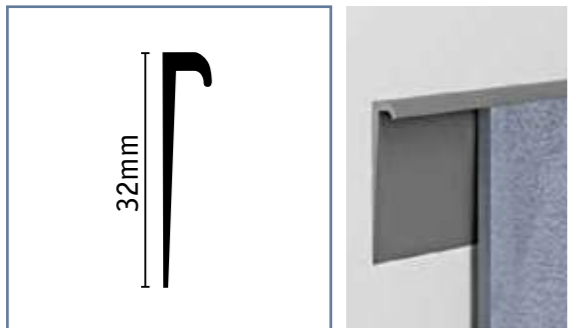

SOLID PVC CAP

32mm x 4.5mm (ext.) x
2.5mm x 2500mm

Delivery: 1 box of 20 pcs = 50

White RAL: 9010 NCS: 1940	26619 001
Beige NCS: S 40-Y30R	26619 002
Brown RAL: L8014V	26619 003
Light Grey NCS: S 4000N	26619 004
Silver RAL: 9022	26619 005

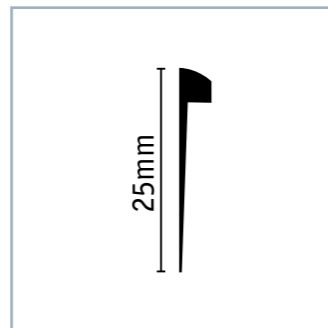

FLEXIBLE PVC CAP

6mm (ext.) x 2.5mm (int.) x
25mm x 25m

Delivery: 1 roll 25lm

Caramel NCS: S 3010-Y30R	26620 001
Dark Grey RAL: 7012 NCS: S 6502-B	26620 002
Light Grey RAL: 7038 NCS: S 3000-N	26620 003
White RAL: 9010 NCS: 1940	26620 004
Aluminium NCS: S 3005-R80B	26620 005

PROTECTWALL - PROFILES

■ SET-ON CORNERS

Aluminium and flexible PVC outside corners used to protect the external corner of walls vs impacts and provide neat finish. Installed over the wall covering.

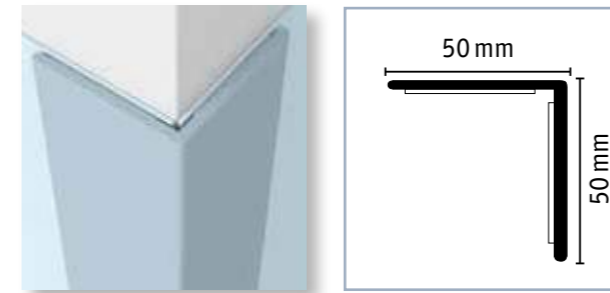

SOLID PVC 90°

Self adhesive
50mm x 50mm x 1000mm

Delivery:
20 pcs in each pack = 18lm

White NCS: S 0603-R80B	26625 101
Light Grey NCS: S 2002-Y50R	26625 102
Light Beige NCS: S 1505-Y	26625 104
Medium Beige NCS: S 1010-Y30R	26625 105

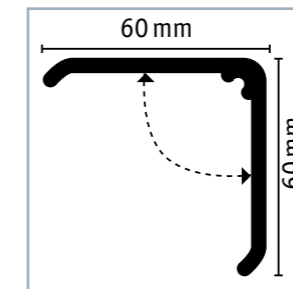

ADJUSTABLE PVC CORNER

Self adhesive
60° à 130°
60mm x 60mm x 2700mm

Delivery:
20 pcs in each pack = 18lm

White NCS: S 0603-R80B	26627 101
----------------------------------	-----------

■ SET-IN CORNERS

Aluminium and flexible PVC outside corners (flexible and solid) used to protect the external corner of walls vs impacts and provide neat finish. Installed under the wall covering.

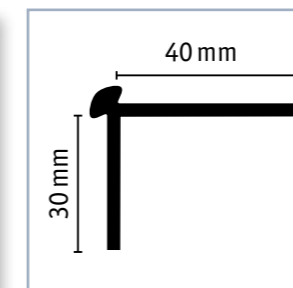

ALUMINIUM

30mm x 40mm x 4.5mm (ext.)
x 2.5mm (int.) x 2500mm

Delivery:
1 box of 10 pcs = 25lm

Silver	26624 001
Stainless steel	26624 002

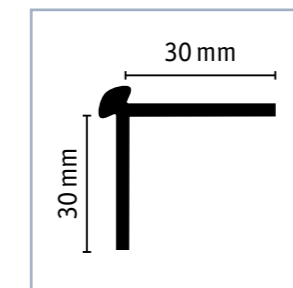

FLEXIBLE PVC

30mm x 30mm x 4.5mm (ext.)
x 2mm (int.) x 2500mm

Delivery: 1 roll 25lm

Caramel NCS: S 3010-Y30R	26623 001
Dark Grey RAL: 7012 NCS: S 6502-B	26623 002
Light Grey RAL: 7038 NCS: S-3000 N	26623 003
White RAL: 9010 NCS: 1940	26623 004
Aluminium NCS: S 3005-R80B	26623 005



SOLID PVC

22.2mm x 20mm x 2.2mm (int.)
x 2600mm

Delivery:
1 box of 20 pcs = 52lm

White RAL: 9010 NCS: S 0603-R80B	26622 001
---	-----------



ACCESSORIES FOR RESILIENT FLOORINGS

UNDERLAYERS ■ FOR WET SUBSTRATE



Tarkolay

- Quicker and more cost-effective solution that copes with up to 7% humidity rate CCM.
- Quick and easy to install and ready-to-use solution.
- Loose-lay and easy to remove solution not to damage the substrate.

Material: PVC coated glass fibre with 0.30mm thick studs

Total weight: 1,160g per m²

Total thickness: 1.3mm

Article code: 3960 004 - Blue

Compatible with: Heterogeneous & Homogeneous vinyl (rolls)

UNDERLAYERS ■ FAST-TRACK RENOVATION SYSTEMS



Jumpax®

- Revolutionary solution for levelling performance offering exceptional stability and resistance.
- Quieter and harder-wearing underlayer, reducing noise by 23 dB with linoleum flooring (21dB with LVT flooring).
- Unparalleled ease of installation and removal, leaving no residue.

Material: MDF, polystyrene foam covered with aluminium film

Total density: 585Kg/m³

Total thickness: 10mm

Article code: 2499 3010

Compatible with:

- LVT click, glued and loose-laid (planks and tiles)
- Homogeneous and heterogeneous flooring (rolls)
- Linoleum (rolls)

UNDERLAYERS ■ FOR UNEVEN SUBSTRATE & FLOOR PRESERVATION



Tarkoflat Loose-lay

- Ready-to-use solution to reduce slight unevenness by up to 1.5mm depth.
- Ideal choice to protect floor during temporary installations.
- Quick and easy to install solution.

Material: calandered PVC foil, loose-lay (naked)

Total weight: 1,500g per m²

Total thickness: 1.0mm

Article code: 3568 004 - Grey

Compatible with:

- LVT click and LVT glued in residential and light commercial* applications (planks and tiles)
- Vinyl rolls for temporary installations (up to one month)



Marathon Dual®

- The ready-to-use solution for renovating over an existing subfloor.
- Easy to install and remove thanks to its simple loose-lay solution.
- Superior performance in impact sound reduction (23dB) and indentation.

Material: MDF and coniferous woods

Total density: 240Kg/m³

Total thickness: 6mm

Article code: 2499 3020

Compatible with:

- LVT click and loose-laid (planks and tiles)
- Heterogeneous loose-laid flooring (rolls)



Tarkoflat Self-adhesive

- Ready-to-use solution to reduce slight unevenness by up to 1.5mm depth.
- Quick and easy to install solution.
- Environmentally-friendly solution (no adhesive needed).

Material: calandered PVC foil, loose-lay (naked)

Total weight: 1,500g per m²

Total thickness: 1.0mm

Article code: 3569 004 - Grey

Compatible with: LVT glued (planks and tiles) in residential applications

* Please contact your technical service



ACCESSORIES FOR RESILIENT FLOORINGS

UNDERLAYERS ■ FOR ACOUSTIC COMFORT



Tarkomfort Premium

- High-performance acoustic insulation: high-impact sound reduction (19 dB with iD Inspiration Click) and in-room noise reduction (72 dB).
- High-performance solution to improve static indentation resistance (0.18mm with iD Inspiration Click).
- Quick and easy to install.

Material: viscoelastic polymer based on polyolefins and EVA
Total weight: 100g per m²
Total thickness: 1mm
Article code: 2499 2030 - Black

Compatible with: iD Inspiration Click (planks and tiles)



Tarkomfort Pro

- Powerful acoustic insulation, reducing both impact sound and in-room noise (13dB).
- Enhanced durability thanks to its high-density, heavy-duty composition (1,500g per m²).
- Simple to install solution with woven anti-slip surface to grip floor covering.

Material: siliconised PET carrier film with high-resistance polyurethane layer and non-woven white fleece backing
Total weight: 1,500 g/m²
Total thickness: 1,5mm
Article code: 2499 2020

Compatible with: LVT click (planks and tiles)



Tarkomfort Self-adhesive

- High-class solution for reducing both impact sound and in-room noise.
- 90% natural raw materials, free from plasticizers and heavy metals.
- Resistance to high-traffic thanks to its high-density material.
- Quick & easy installation with self-adhesive surface.

Material: transparent PET-foil and heavy-duty polyurethane layer, with mineral fillers and polyurethane binders
Total weight: 2,600 g/m²
Total thickness: 1,80mm
Article code: 2499 2040

Compatible with: LVT glued and loose-laid (planks and tiles) in residential and light commercial areas*

UNDERLAYERS ■ FOR ACOUSTIC COMFORT



Elafono

- High-performance acoustic insulation: in-room noise (up to 65 dB) and impact sound (up to 15 dB) reduction with any compact linoleum.
- 100% natural.
- Superior performances in static indentation, thermal resistance and underfoot comfort.

Material: cork linoleum underlayer
Total weight: 1,450g per m²
Total thickness: 2,0mm
Article code: 1861 030 - Brown

Compatible with:
 - Compact Linoleum (rolls)
 - Homogeneous vinyls (rolls)



Tarkomousse

- Improved acoustic comfort in wet areas: in-room acoustic performance by up to 19dB (Granit Multisafe).
- Greater walking comfort.
- Superior durability.

Material: PVC foam
Total weight: 1,200g per m²
Total thickness: 2,0mm
Article code: 3965 001 - Grey

Compatible with: Wetroom floorings

* Please contact your technical service



ACCESSORIES FOR ALL TYPES OF FLOORING

UNDERLAYERS ■ FOR DAMP PROOF

TarkoDry Wall & Floor

- Watertight layer under ceramic tile (wetroom floor and wall) for a safe and long-lasting solution.
- Long-term waterproof warranty.
- Internally flexible homogeneous structure for easy installation and welding.



TarkoDry Wall

Material: homogeneous PVC underlayer

Total weight: 2,600g per m²

Total thickness: 1,5mm

Article code: 3138 027 - Grey

Compatible with: ceramic tiles

TarkoDry Floor

Material: homogeneous PVC underlayer

Total weight: 2,000g per m²

Total thickness: 1,2mm

Article code: 3137 028 - Grey

Compatible with: ceramic tiles

OVERLAYERS ■ FOR FLOOR PROTECTION

Tarkoprotect 180

- High-performance protection and safety and perfect grip to flooring.
- Cost-effective solution by avoiding cleaning or replacement.
- Loose-lay installation to be removed easily and re-used.



Tarkoprotect 180

Material: tackified polyester veil reinforced with PE foil

Total weight: 180g per m²

Total thickness: 1,2mm

Article code: 24990 000 - White

Compatible with: all types of flooring

ADHESIVES ■ SPRAY

■ TARKOSPRAY



Water based and easy to use flooring adhesive as a spray: 70% faster to apply, immediately ready for use and ideal for easy renovation, and environmental friendly.



Article codes:

France / Germany / The Netherlands 1460 001
United Kingdom / Poland

Italy / Spain / Sweden / Portugal 1460 005

1 box of 6 cans + 1 trigger.
Min order: 20 boxes.

SPECIAL STRIPS ■ STATIC CONTROL STRIPS FOR ROLLS

■ COPPER STRIPS



Copper thread to be installed in a grid-pattern underneath the flooring to facilitate static dissipative properties.

SAP code: 1256 727



ACCESSORIES FOR RESILIENT FLOORINGS

FLOORCRAFT THE PROCESS

In every building, the floor covering can have a huge influence on the look and feel of the entire environment. The FLOORCRAFT Design Service helps designers, architects, planners and building owners to make the most of this creative opportunity. This service offers almost limitless scope for stunning effects and eye-catching concepts. Launched in 1993, FLOORCRAFT is a unique and increasingly versatile service facility. Each idea is explored and visualised. When the final design is approved, it is translated into a computer program for precision cutting.

However simple or complex the original design brief, the service offers clients proven versatility. Our experienced team is ready to apply their FLOORCRAFT's skills to your project, building on your ideas and helping to bring them to life. The sonic cut components are manually assembled into panels and clear adhesive tape is placed on the surface to hold the pieces together during installation and removed once the flooring adhesive has set. A detailed plan is provided with all panels labelled. Larger features will be supplied in multiple panels. Sonic cutting can be used to create intricate designs that will fit together precisely.



- The sonic blade oscillates at 20,000 cycles per second. This creates a sonic wave around the blade.
- As the blade approaches the flooring product, molecules move apart in the flooring and a cut line is created with no loss or damage to the material surface.
- The computer program controls the position of each cut line and also the pattern consistency.
- The individual pieces are then assembled for a perfect fit.



1 Initial Sketches are developed into final designs.



2 Final designs are drawn using computer software to produce cutting programs.

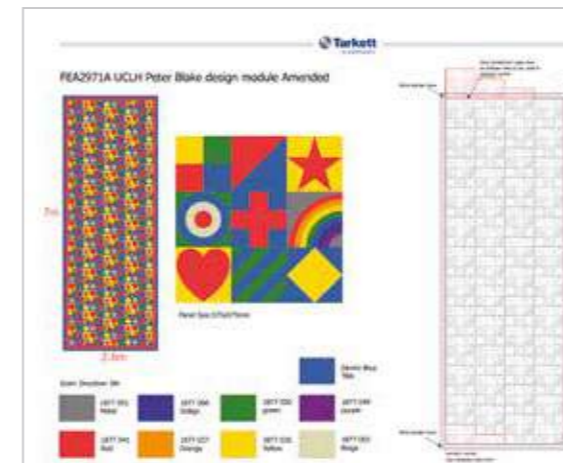

3 Detailed plans make installation easier.



4 Cutting programs are transferred to our sonic cutting machines.



5 The cut pieces are then assembled in our factory.



6 Ready to be sent to the site for installation.



ACCESSORIES FOR RESILIENT FLOORINGS

FLOORCRAFT DESIGN LIBRARY

The FLOORCRAFT Design Library has an extensive range of standard designs that can be implemented in any colour, and with practically any flooring in the Tarkett portfolio (please see your local sales rep for complete up to date list). You can also choose to provide us with your own design or to create a design together with our designers.

The appearance of the floor can be emphasised by using imaginative decorative borders. In addition to aesthetic appeal, these designs can also be used to define different areas, or to indicate a path for pedestrians.

BORDERS & BLOCKS



Harlequin Border



Braid Border



Ribbon Border



Circle Border



Square Border



Surf Border



Rope Border

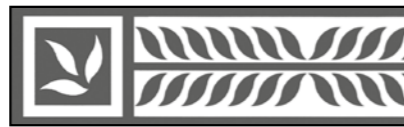

Floral Border



Victorian Border



Roman Key Border



Geometric Border

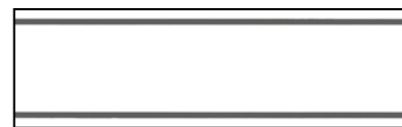

Traditional Border

ROSETTES & BORDERS



3D Pyramid



Around



Baroque



Celtic Rose



Convergence

URBAN & DIGITAL INSPIRATION



City



Flash code



Map dots



Music



Shopping time

NATURAL FEEL



Birdy



Dandelion



Waterbanch



Ecology



Expressice flower

BABIES



Girls



Koala



Plane



B



1

CHILDREN



Lion



Boy-girl toilet



Alien



Panda



Crossroads

TEENAGERS

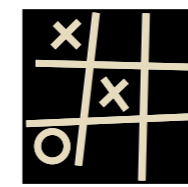

oxo

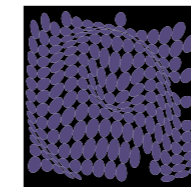

3D circle



Player



Globe

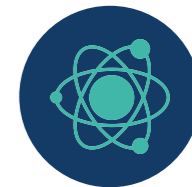

Atome



ACCESSORIES FOR HARD FLOORINGS

MATCHING ACCESSORIES - WOOD

Tarkett offers a wide selection of accessories to complete the appearance of your wooden floor.







Since wood is a living material you should always leave a space – an expansion gap – of 1.5mm per metre of floor, or at least 8–10mm between the floor and walls, thresholds, pipes, steps, fireplaces, stone floors etc. The expansion gap can be concealed using skirtings, mouldings and pipe collars.



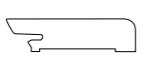

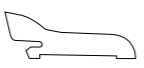
Clipstar and Alustar veneer skirtings are available in a large

assortment of wood species. Clipstar is extremely user-friendly: the skirtings are simply mounted on clips that are attached to the wall separately. Alustar, aluminium covered with veneer for high stability and durability, is suitable for high traffic areas. The reducer can also be used as a T-profile.

Matching surface finish

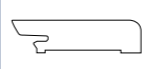
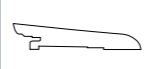
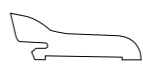

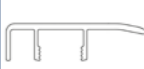



Regardless of surface treatment you'll be able to find matching skirtings.

VENEER SKIRTINGS	CLIPSTAR - VENEER			ALUSTAR - ALUMINIUM/VENEER		QUADRANT
	Skirting			Reducer	End Profile	Quadrant
						
DIMENSIONS	60 x 16 x 2400mm	80 x 16 x 2400mm	60 x 22 x 2400mm	43 x 8 x 900mm	34 x 8 x 900mm	19 x 12 x 2400mm
Oak	8791 734	8791 760	8791 770	8791 910	8791 939	8791 900
Oak Brushed	8791 843			8791 911	8791 940	
Oak White	8791 736			8791 912	8791 941	
Oak White Light	8791 853			8791 913	8791 942	
Oak Cotton White	8791 841			8791 914	8791 943	
Oak Lime Stone	8791 845			8791 915	8791 944	
Oak Blonde	8791 846			8791 916	8791 945	
Oak Java	8791 737			8791 917	8791 946	
Oak Black	8791 754			8791 918	8791 947	
Oak Cumin	8791 758			8791 919	8791 948	
Oak Umber Brown	8791 847			8791 920	8791 949	
Oak Old Brown	8791 848			8791 921	8791 950	
Oak Dark Grey	8791 756			8791 922	8791 951	
Oak Light Grey	8791 757			8791 923	8791 952	
Oak Warm Grey	8791 854			8791 924	8791 953	
Oak Evening Grey	8791 849			8791 925	8791 954	
Oak Old Grey	8791 850			8791 926	8791 955	
Oak Urban Grey	8791 851			8791 927	8791 956	
Ash	8791 738			8791 928	8791 957	
Ash White	8791 741			8791 929	8791 958	
Ash White Pearl	8791 842			8791 930	8791 959	

VENEER SKIRTINGS	CLIPSTAR - VENEER			ALUSTAR - ALUMINIUM/VENEER		QUADRANT
	Skirting			Reducer	End Profile	Quadrant
						
DIMENSIONS	60 x 16 x 2400mm	80 x 16 x 2400mm	60 x 22 x 2400mm	43 x 8 x 900mm	34 x 8 x 900mm	19 x 12 x 2400mm
Ash Ivory	8791 852			8791 931	8791 960	
Maple	8791 742			8791 932	8791 961	
Beech	8791 744			8791 933	8791 962	
Walnut	8791 745			8791 934	8791 963	
Oak Stone Grey	8791 832			8791 936	8791 965	
Oak Praline	8791 834			8791 937	8791 966	
Oak Winter	8791 839			8791 938	8791 967	
Oak Dove Grey	8791 777			8791 968	8791 975	
Oak Dark Night	8791 778			8791 969	8791 976	
Oak Concrete	8791 779			8791 970	8791 977	
Oak Charcoal	8791 780			8791 971	8791 978	
Oak Soft Grey	8791 781			8791 972	8791 979	
Ash Ginger	8791 782			8791 973	8791 980	
Birch	8791 783			8791 974	8791 981	
White Foiled	8791 740			8791 935	8791 964	8791 907

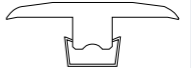
CLIPS FOR CLIPSTAR SKIRTINGS

50 clips in a box		8791 800
-------------------	---	----------

SOLID PROFILES	TRANSITION MOULDING						END COVER	STAIRNOSE		
	Reducer		Square		Threshold		End Cover	Stairnose		
										
FLOOR THICKNESS	13-17mm	8-12mm	13-17mm	8-12mm	13-17mm	8-12mm		13-14mm	8,5mm	13-14mm
DIMENSIONS	58 x 19 x 2000mm	44 x 12 x 2000mm	38 x 19 x 2000mm	32 x 12 x 2000mm	58 x 20 x 2000mm	44 x 12 x 2000mm	21 x 9 x 2000mm	66 x 20 x 2000mm	48 x 19 x 2000mm	60 x 26 x 2000mm
Oak	8791 107	8791 126	8791 136	8791 144	8791 157	8791 175	8791 300	8791 446	8791 505	8791 466
Oak Unfinished	8791 105		8791 134		8791 152					8791 465

PIPE COVERS IN SOLID WOOD

	17,1 mm	22,0 mm
Oak	8791 810	8791 811
Oak Unfinished	8791 825	8791 826
Beech	8791 812	8791 813
Ash	8791 814	8791 815
Maple	8791 816	8791 817
Dark (stained)	8791 818	8791 819







DOUBLE PIPE COVERS IN SOLID WOOD





Holes to be drilled afterwards		
Oak		8791 820
Oak Unfinished		8791 827







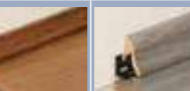
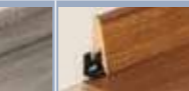

ACCESSORIES FOR HARD FLOORINGS

PROFILES AND SKIRTINGS FOR LAMINATE

ACCESSORIES	3 IN 1	SCOTIA	MEDIUM SKIRTING	LARGE SKIRTING	EXTRA LARGE SKIRTING
					
DIMENSIONS	7,5 x 18 x 930 mm	16 x 16 x 2400 mm	20 x 40 x 2400 mm	17 x 60 x 2400 mm	15 x 90 x 2400 mm
PACKAGING	Only by unit	4 pieces in 1 box	Packed by 5	Packed by 5	Packed by 5
WELCOME 100% MATCHING ACCESSORIES					
Deep Honey Sherwood Oak decor code: 214	8014 003	8007 214	42400 214	42600 214	8009 214
Mocca Sherwood Oak decor code: 216	8014 003	8007 216	42400 216	42600 216	8009 216
Suede Sherwood Oak decor code: 217	8014 003	8007 217	42400 217	42600 217	8009 217
Beige Sherwood Oak decor code: 218	8014 003	8007 218	42400 218	42600 218	8009 218
Black & hipe decor code: 239	8014 003	8007 239	42400 239	42600 239	8009 239
Grey Beige Sherwood Oak decor code: 288	8014 003	8007 288	42400 288	42600 288	8009 288
White & Hype decor code: 240	8014 003	8007 240	42400 240	42600 240	8009 240
Heritage Grey Oak decor code: 381	8014 003	8007 381	42400 381	42600 381	8009 381
Heritage Rustic Oak decor code: 380	8014 003	8007 380	42400 380	42600 380	8009 380
Barn Oak decor code: 392	8014 003	8007 392	42400 392	42600 392	8009 392

ACCESSORIES	TRANSITION PROFILE	REDUCTION PROFILE	SCOTIA	MEDIUM SKIRTING	LARGE SKIRTING	EXTRA LARGE SKIRTING
						
DIMENSIONS	10 x 44 x 2000 mm	12 x 44 x 2000 mm	16 x 16 x 2400 mm	20 x 40 x 2400 mm	17 x 60 x 2400 mm 18 X 58 x 2400 mm*	15 x 90 x 2400 mm
PACKAGING	Only by unit	Only by unit	4 pieces in 1 box	Packed by 5	Packed by 5	Packed by 5
ESSENTIALS 832 coordinated accessories						
Beech 3 Strip Medium decor code: 013	8004 003	8005 005	8007 006	42400 006	42600 006	8009 006
Old World Walnut decor code: 197	8004 197	8005 197	8007 197	42400 197	42600 197	8009 197
Dark Fumes Oak decor code: 212	8004 212	8005 212	8007 212	42400 212	42600 212	8009 212
Walnut decor code: 279	8004 279	8005 279	8007 279	42400 279	42600 279	8009 279















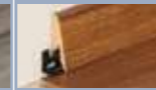

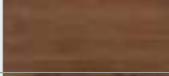

PROFILES AND SKIRTINGS FOR LAMINATE

ACCESSORIES	TRANSITION PROFILE	REDUCTION PROFILE	SCOTIA	MEDIUM SKIRTING	LARGE SKIRTING	EXTRA LARGE SKIRTING
						
DIMENSIONS	10 x 44 x 2000 mm	12 x 44 x 2000 mm	16 x 16 x 2400 mm	20 x 40 x 2400 mm	17 x 60 x 2400 mm 18 X 58 x 2400 mm*	15 x 90 x 2400 mm
PACKAGING	Only by unit	Only by unit	4 pieces in 1 box	Packed by 5	Packed by 5	Packed by 5
ESSENTIALS 832 coordinated accessories						
Oak Plank Middle decor code: 335	8004 218	8005 218	8007 218	42400 218	42600 218	8009 218
Oak Plank Natural decor code: 336	8004 223	8005 223	8007 223	42400 223	42600 223	8009 223
Oak Plank Grey decor code: 337	8004 337	8005 337	8007 337	42400 337	42600 337	8009 337
Contrasting Meringue decor code: 345	8004 326	8005 326	8007 326	42400 326	42600 326	8009 326
Modern Wenge decor code: 346	8004 303	8005 303	8007 303	42400 303	42600 303	8009 303
Brushed Oak decor code: 347	8004 347	8005 347	8007 347	42400 347	42600 347	8009 347
Beige Maple decor code: 350	8004 301	8005 301	8007 301	42400 301	42600 301	8009 301
Caramel Oak decor code: 352	8004 352	8005 352	8007 352	42400 352	42600 352	8009 352
Light Misty Walnut decor code: 354	8004 354	8005 354	8007 354	42400 354	42600 354	8009 354
Grey Pepper Oak decor code: 370	8004 370	8005 370	8007 370	42400 370	42600 370	8009 370
Heritage Rustic Oak decor code: 380	8004 380	8005 380	8007 380	42400 380	42600 380	8009 380
Vanilla Oak decor code: 406	8004 406	8005 406	8007 406	42400 406	42600 406	8009 406
Doussie decor code: 407	8004 407	8005 407	8007 407	42400 407	42600 407	8009 407
Jatoba decor code: 411	8004 411	8005 411	8007 411	42400 411	42600 411	8009 411
Broceliande Oak Brown decor code: 414	8004 414	8005 414	8007 414	42400 414	42600 414	8009 414
Mahogany 2S decor code: 428	8004 428	8005 428	8007 428	42400 428	42600 428	8009 428
Aged Oak decor code: 429	8004 429	8005 429	8007 429	42400 429	42600 429	8009 429
Cotton Oak Beige decor code: 442	8004 442	8005 442	8007 442	42400 442	42300 442*	8009 442
Country Oak Beige decor code: 543	8004 543	8005 543	8007 543	42400 543	42300 543*	8009 543
Cherry Plank decor code: 544	8004 544	8005 544	8007 544	42400 544	42300 544*	8009 544
Cotton Oak White decor code: 547	8004 547	8005 547	8007 547	42400 547	42300 547*	8009 547
Infinite Walnut decor code: 279	8004 279	8005 279	8007 279	42400 279	42600 279	8009 279

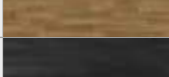
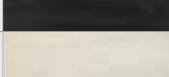

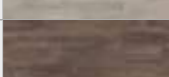

















ACCESSORIES FOR HARD FLOORINGS

PROFILES AND SKIRTINGS ■ FOR LAMINATE

ACCESSORIES	TRANSITION PROFILE	REDUCTION PROFILE	SCOTIA	MEDIUM SKIRTING	LARGE SKIRTING	EXTRA LARGE SKIRTING	
							
DIMENSIONS	10 x 44 x 2000 mm	12 x 44 x 2000 mm	16 x 16 x 2400 mm	20 x 40 x 2400 mm	17 x 60 x 2400 mm 18 X 58 x 2400 mm*	15 x 90 x 2400 mm	
PACKAGING	Only by unit	Only by unit	4 pieces in 1 box	Packed by 5	Packed by 5	Packed by 5	
WOODSTOCK 832 100% MATCHING ACCESSORIES							
Deep Honey Sherwood Oak decor code: 214		8004 214	8005 214	8007 214	42400 214	42600 214	8009 214
Tobacco Sherwood Oak decor code: 215		8004 215	8005 215	8007 215	42400 215	42600 215	8009 215
Mocha Sherwood Oak decor code: 216		8004 216	8005 216	8007 216	42400 216	42600 216	8009 216
Suede Sherwood Oak decor code: 217		8004 217	8005 217	8007 217	42400 217	42600 217	8009 217
Beige Sherwood Oak decor code: 218		8004 218	8005 218	8007 218	42400 218	42600 218	8009 218
Princess Fontainebleau Oak decor code: 222		8004 222	8005 222	8007 222	42400 222	42600 222	8009 222
Queen Fontainebleau Oak decor code: 223		8004 223	8005 223	8007 223	42400 223	42600 223	8009 223
King Fontainebleau Oak decor code: 224		8004 224	8005 224	8007 224	42400 224	42600 224	8009 224
Black & Hype decor code: 239		8004 239	8005 239	8007 239	42400 239	42600 239	8009 239
White & Hype decor code: 240		8004 240	8005 240	8007 240	42400 240	42600 240	8009 240
Grey Beige Sherwood Oak decor code: 288		8004 288	8005 288	8007 288	42400 288	42600 288	8009 288
Grey Mocha Sherwood Oak decor code: 289		8004 289	8005 289	8007 289	42400 289	42600 289	8009 289
Soft Saffron Oak decor code: 364		8004 364	8005 364	8007 364	42400 364	42600 364	8009 364
Soft Cumin Oak decor code: 365		8004 365	8005 365	8007 365	42400 365	42600 365	8009 365
Grey Pepper Oak decor code: 370		8004 370	8005 370	8007 370	42400 370	42600 370	8009 370

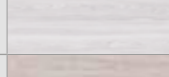
PROFILES AND SKIRTINGS ■ FOR LAMINATE

ACCESSORIES	TRANSITION PROFILE	REDUCTION PROFILE	SCOTIA	MEDIUM SKIRTING	LARGE SKIRTING	EXTRA LARGE SKIRTING	
							
DIMENSIONS	10 x 44 x 2000 mm	12 x 44 x 2000 mm	16 x 16 x 2400 mm	20 x 40 x 2400 mm	17 x 60 x 2400 mm 18 X 58 x 2400 mm*	15 x 90 x 2400 mm	
PACKAGING	Only by unit	Only by unit	4 pieces in 1 box	Packed by 5	Packed by 5	Packed by 5	
WOODSTOCK 832 100% MATCHING ACCESSORIES							
Forest Oak Cloud decor code: 399		8004 399	8005 399	8007 399	42400 399	42600 399	8009 399
Forest Oak Clay decor code: 400		8004 400	8005 400	8007 400	42400 400	42600 400	8009 400
Forest Oak Gold decor code: 401		8004 401	8005 401	8007 401	42400 401	42600 401	8009 401
Forest Oak Praline decor code: 402		8004 402	8005 402	8007 402	42400 402	42600 402	8009 402
Broceliande Oak Light decor code: 412		8004 412	8005 412	8007 412	42400 412	42600 412	8009 412
Broceliande Oak Brown decor code: 414		8004 414	8005 414	8007 414	42400 414	42600 414	8009 414
NORDIC SOUL 832 100% MATCHING ACCESSORIES							
Melody Oak Grey decor code: 532		8004 532	8005 532	8007 532	42400 532	42300 532*	8009 532
Melody Oak Cream decor code: 533		8004 533	8005 533	8007 533	42400 533	42300 533*	8009 533
Harmony Ash Authentic decor code: 536		8004 536	8005 536	8007 536	42400 536	42300 536*	8009 536
Harmony Ash Limed decor code: 545		8004 545	8005 545	8007 545	42400 545	42300 545*	8009 545
Poetic Oak Sand decor code: 540		8004 540	8005 540	8007 540	42400 540	42300 540*	8009 540
Poetic Oak Silk decor code: 541		8004 541	8005 541	8007 541	42400 541	42300 541*	8009 541























ACCESSORIES FOR HARD FLOORINGS

PROFILES AND SKIRTINGS FOR LAMINATE

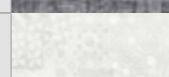
ACCESSORIES	TRANSITION PROFILE	REDUCTION PROFILE	SCOTIA	MEDIUM SKIRTING	LARGE SKIRTING	EXTRA LARGE SKIRTING	
							
DIMENSIONS	10 x 44 x 2000 mm	12 x 44 x 2000 mm	16 x 16 x 2400 mm	20 x 40 x 2400 mm	17 x 60 x 2400 mm 18 X 58 x 2400 mm*	15 x 90 x 2400 mm	
PACKAGING	Only by unit	Only by unit	4 pieces in 1 box	Packed by 5	Packed by 5	Packed by 5	
VINTAGE 832	100% MATCHING ACCESSORIES						
Bourbon Oak decor code: 210		8004 210	8005 210	8007 210	42400 210	42600 210	8009 210
Sunset Sand Oak 2-Strip decor code: 325		8004 325	8005 325	8007 325	42400 325	42600 325	8009 325
Dayspring Rainbow decor code: 326		8004 326	8005 326	8007 326	42400 326	42600 326	8009 326
Moonshadow Light Oak decor code: 328		8004 328	8005 328	8007 328	42400 328	42600 328	8009 328
Bergamo Grey Oak decor code: 362		8004 362	8005 362	8007 362	42400 362	42600 362	8009 362
Heritage Rustic Oak decor code: 380		8004 380	8005 380	8007 380	42400 380	42600 380	8009 380
Heritage Grey Oak decor code: 381		8004 381	8005 381	8007 381	42400 381	42600 381	8009 381
Heritage Light Oak decor code: 385		8004 385	8005 385	8007 385	42400 385	42600 385	8009 385
Barn Oak decor code: 392		8004 392	8005 392	8007 392	42400 392	42600 392	8009 392
Nostalgic Spruce decor code: 426		8004 426	8005 426	8007 426	42400 426	42600 426	8009 426
Antique Pine decor code: 434		8004 434	8005 434	8007 434	42400 434	42600 434	8009 434
Heritage Royal Oak decor code: 534		8004 534	8005 534	8007 534	42400 534	42300 534*	8009 534
Craft Oak Gold decor code: 537		8004 537	8005 537	8007 537	42400 537	42300 537*	8009 537
Craft Oak Granite decor code: 538		8004 538	8005 538	8007 538	42400 538	42300 538*	8009 538
Craft Oak Clay decor code: 539		8004 539	8005 539	8007 539	42400 539	42300 539*	8009 539
Heritage Authentic Oak decor code: 546		8004 546	8005 546	8007 546	42400 546	42300 546*	8009 546







PROFILES AND SKIRTINGS FOR LAMINATE



ACCESSORIES	TRANSITION PROFILE	REDUCTION PROFILE	SCOTIA	MEDIUM SKIRTING	LARGE SKIRTING	EXTRA LARGE SKIRTING	
							
DIMENSIONS	10 x 44 x 2000 mm	12 x 44 x 2000 mm	16 x 16 x 2400 mm	20 x 40 x 2400 mm	17 x 60 x 2400 mm 18 X 58 x 2400 mm*	15 x 90 x 2400 mm	
PACKAGING	Only by unit	Only by unit	4 pieces in 1 box	Packed by 5	Packed by 5	Packed by 5	
LAMIN'ART 832	100% MATCHING ACCESSORIES						
Black & White decor code: 238		8004 239	8005 239	8007 239	42400 239	42600 239	8009 239
Black Buzz decor code: 241		8004 239	8005 239	8007 239	42400 239	42600 239	8009 239
White Buzz decor code: 242		8004 240	8005 240	8007 240	42400 240	42600 240	8009 240
Patchwork Cappuccio decor code: 296		8004 296	8005 296	8007 186	42400 186	42600 186	8009 186
Patchwork Latte decor code: 297		8004 322	8005 322	8007 187	42400 187	42600 187	8009 187
Painted White decor code: 299		8004 322	8005 322	8007 299	42400 299	42600 299	8009 299
Wild Light Stone decor code: 356		8004 356	8005 356	8007 356	42400 356	42600 356	8009 356
Wild Dark Stone decor code: 357		8004 357	8005 357	8007 357	42400 357	42600 357	8009 357
Antique Paint decor code: 387		8004 387	8005 387	8007 387	42400 387	42600 387	8009 387
Taiga Pine decor code: 433		8004 433	8005 433	8007 433	42400 433	42600 433	8009 433
Painted Black decor code: 525		8004 525	8005 525	8007 525	42400 525	42300 525*	8009 525
Patchwork Black decor code: 526		8004 526	8005 526	8007 526	42400 526	42300 526*	8009 526
Fusion White decor code: 535		8004 535	8005 535	8007 535	42400 535	42300 535*	8009 535
Fusion Black decor code: 542		8004 542	8005 542	8007 542	42400 542	42300 542*	8009 542
Manor Oak Classic decor code: 553		8004 553	8005 553	8007 553	42400 553	42300 553*	8009 553
Manor Oak Vogue decor code: 554		8004 554	8005 554	8007 554	42400 554	42300 554*	8009 554









ACCESSORIES FOR HARD FLOORINGS

PROFILES AND SKIRTINGS FOR LAMINATE

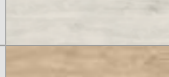





ACCESSORIES	TRANSITION PROFILE	REDUCTION PROFILE	SCOTIA	MEDIUM SKIRTING	LARGE SKIRTING	EXTRA LARGE SKIRTING
						
DIMENSIONS	10 x 44 x 2000 mm	12 x 44 x 2000 mm	16 x 16 x 2400 mm	20 x 40 x 2400 mm	17 x 60 x 2400 mm 18 X 58 x 2400 mm*	15 x 90 x 2400 mm
PACKAGING	Only by unit	Only by unit	4 pieces in 1 box	Packed by 5	Packed by 5	Packed by 5











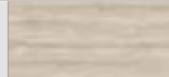

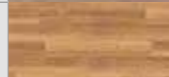

LOFT 832		100% MATCHING ACCESSORIES					
Dark Sand decor code: 281		8004 281	8005 281	8007 281	42400 281	42600 281	8009 281
Light Sand decor code: 282		8004 282	8005 282	8007 282	42400 282	42600 282	8009 282
Concrete Dark decor code: 283		8004 283	8005 283	8007 283	42400 283	42600 283	8009 283
Concrete Light decor code: 284		8004 284	8005 284	8007 284	42400 284	42600 284	8009 284
Soft Concrete Dark decor code: 438		8004 438	8005 438	8007 438	42400 438	42300 438*	8009 438
French Slate Black decor code: 439		8004 439	8005 439	8007 439	42400 439	42300 439*	8009 439
Storm Slate Dark decor code: 440		8004 440	8005 440	8007 440	42400 440	42300 440*	8009 440
Storm Slate Sand decor code: 441		8004 441	8005 441	8007 441	42400 441	42300 441*	8009 441
Soft Concrete Light decor code: 443		8004 443	8005 443	8007 443	42400 443	42300 443*	8009 443

INFINITE 832		100% MATCHING ACCESSORIES					
Dark Shade Oak decor code: 276		8004 276	8005 276	8007 276	42400 276	42600 276	8009 276
Light Shade Oak decor code: 277		8004 277	8005 277	8007 277	42400 277	42600 277	8009 277
White Oak decor code: 300		8004 300	8005 300	8007 300	42400 300	42600 300	8009 300
Beige Oak decor code: 301		8004 301	8005 301	8007 301	42400 301	42600 301	8009 301
Honey Oak decor code: 302		8004 302	8005 302	8007 302	42400 302	42600 302	8009 302
Coffee Oak decor code: 303		8004 303	8005 303	8007 303	42400 303	42600 303	8009 303

WHITE SKIRTING FOR ALL							
White - paintable if needed decor code: All		-	-	-	-	42300 000*	-

PROFILES AND SKIRTINGS FOR LAMINATE

ACCESSORIES	TRANSITION PROFILE	REDUCTION PROFILE	SCOTIA	MEDIUM SKIRTING	LARGE SKIRTING	EXTRA LARGE SKIRTING
						
DIMENSIONS	10 x 44 x 2000 mm	12 x 44 x 2000 mm	16 x 16 x 2400 mm	20 x 40 x 2400 mm	17 x 60 x 2400 mm 18 X 58 x 2400 mm*	15 x 90 x 2400 mm
PACKAGING	Only by unit	Only by unit	4 pieces in 1 box	Packed by 5	Packed by 5	Packed by 5

LONG BOARDS 932		100% MATCHING ACCESSORIES					
Moonshadow Light Oak decor code: 328		8004 328	8005 328	8007 328	42400 328	42600 328	8009 328
Heritage Rustic Oak decor code: 380		8004 380	8005 380	8007 380	42400 380	42600 380	8009 380
Heritage Grey Oak decor code: 381		8004 381	8005 381	8007 381	42400 381	42600 381	8009 381
Barn Oak decor code: 392		8004 392	8005 392	8007 392	42400 392	42600 392	8009 392
Classic Oak Natural decor code: 408		8004 408	8005 408	8007 408	42400 408	42600 408	8009 408
Snow Oak decor code: 409		8004 409	8005 409	8007 409	42400 409	42600 409	8009 409
Nostalgic Pine decor code: 425		8004 425	8005 425	8007 425	42400 425	42600 425	8009 425
Nostalgic Spruce decor code: 426		8004 426	8005 426	8007 426	42400 426	42600 426	8009 426
Soft Ginger Oak decor code: 435		8004 435	8005 435	8007 435	42400 435	42600 435	8009 435
Heritage Royal Oak decor code: 534		8004 534	8005 534	8007 534	42400 534	42300 534*	8009 534
Craft Oak Gold decor code: 537		8004 537	8005 537	8007 537	42400 537	42300 537*	8009 537
Craft Oak Granite decor code: 538		8004 538	8005 538	8007 538	42400 538	42300 538*	8009 538
Craft Oak Clay decor code: 539		8004 539	8005 539	8007 539	42400 539	42300 539*	8009 539
Heritage Authentic Oak decor code: 546		8004 546	8005 546	8007 546	42400 546	42300 546*	8009 546



ACCESSORIES FOR HARD FLOORINGS

UNDERLAYERS FOR WOOD

SOLUTION FOR UNEVEN FLOOR & ACOUSTIC COMFORT



Tarkoflex II

- High-Effective and immediate solution to reduce smaller bumps and indentations by up to 1.5mm depth and 3mm width
- Extreme durability thanks to its polyethylene foam and its high-density composition
- High-impact sound reduction, up to 19dB with 14mm wood flooring

Material: Polyethylene foam with a 100µ moisture-barrier film
Total weight: 150g per m²
Total thickness: 2.0mm
Article code: 8790312 / 8790316

Compatible with: Wood floorings (planks)



Tarkofoam II

- Reduction of slight unevenness by up to 1.5mm depth and 3mm width
- High durability thanks to its polyethylene foam material
- High-impact sound reduction, up to 19dB with 14mm wood flooring

Material: Polyethylene foam
Total weight: 60g per m²
Total thickness: 2.0mm
Article code: 8790314 / 8790315

Compatible with: Wood floorings (planks)

UNDERLAYERS FOR LAMINATE

SOLUTION FOR WET SUBSTRATE, UNEVEN FLOOR & ACOUSTIC COMFORT



3in1 SoundBlock Foam 19dB

- Vapour barrier solution to prevent consequences from humidity
- Ready-to-use solution to level slight undulations in older subfloors
- Superior performance in impact sound reduction, up to 19dB
- Trouble-free installation, requiring simple loose-lay installation

Material: Recyclable polyethylene foam, freon-free, with closed-cell structure
Total weight: 0.2kg per m²
Total thickness: 3.0mm
Article code: 8267000

Compatible with: Laminate floorings

SOLUTION FOR UNEVEN FLOOR & ACOUSTIC COMFORT



Standard Foam 18dB

- Ready-to-use solution reducing slight unevenness in older subfloors
- Good stability and a free-floating underlay system
- High impact sound reduction, up to 18dB

Material: Recyclable polyethylene foam, freon-free
Total weight: 0.05kg per m²
Total thickness: 2.0mm
Article code: 8021000

Compatible with: Laminate floorings

SOLUTION FOR WET SUBSTRATE



Vapour Barrier

- Quick and cost-effective solution
- Permanent protection against moisture in the subfloor (sd>100m)
- Enhanced durability via polyethylene-foam composition

Material: Polyethylene foam with a 200µ moisture-barrier film
Total weight: 0.05kg per m²
Total thickness: 1.2mm
Article code: 8021001

Compatible with: Laminate floorings



ACCESSORIES FOR SPORTS FLOORINGS

RESILIENT FINISHING ACCESSORIES

WOOD VENTILATED SKIRTINGS

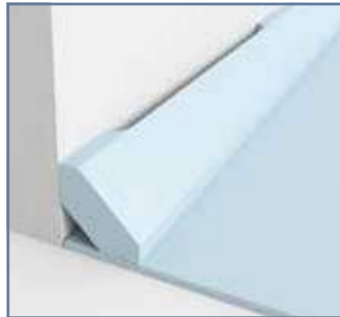

Specific wood varnished skirting with spaces made to allow cross ventilation of the vinyl flooring when installed with GreenLay® method.

	Wood Ventilated Skirting	
	(standard)	(wide)
Oak varnished	1551067	1551068
Beech varnished	1551065	1551066
Maple varnished	1551069	1551070

Wood Ventilated Skirting (standard)	Wood Ventilated Skirting (wide)
1 box of 5 units=11.75 lm	1 box of 4 units=9.40 lm
Thickness: 22mm	Thickness: 27mm
Width: 65 mm	Width: 84 mm
Length: 2350mm	Length: 2350mm

VINYL SKIRTINGS

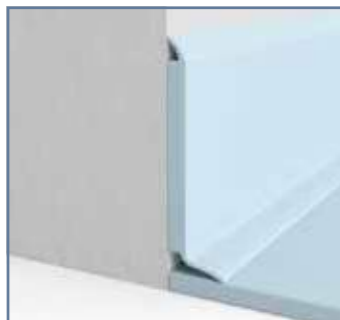

Flexible PVC skirting for Omnisports range used in sports halls to finish the installation.
Available in 5 colours and 3 wood species.

1 box of 20 pcs = 51.40lm
60mm high x 15mm wide x 2570mm long

Characteristics	Article code
Beech	1551064
Maple	1551062
Oak	1551063
Royal blue	1551061
Sky blue	1551059

THRESHOLD STRIP



Aluminium one-piece transition strip used to join the sport flooring to surrounding floorings. Reinforced for heavy loading and striated for better grip. 4 different sizes to match various thickness differences. To be screwed.

60 or 80mm wide: 1 box of 10 pcs = 30lm
100 or 130mm wide: 1 box of 5 pcs = 15lm
5mm high x 3000mm long

Characteristics	Article code
60mm wide	1551078
80mm wide	1551079
100mm wide	1551080
130mm wide	1551081

ADAPTABLE TRANSITION STRIP

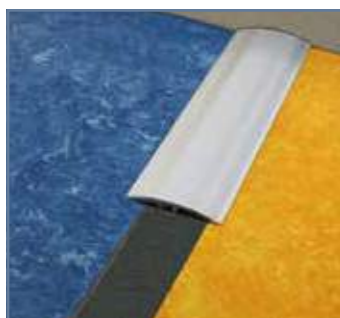

Aluminium adaptable transition strip for floorings with leveling up to 14mm. Striated for a better grip. To be screwed.

1 box of 10 pcs = 27lm
41mm high x 2700mm long
Article code: 1551071

RESILIENT INSTALLATION ACCESSORIES

LINOFINISH



PU finish for Linosport Classic (4mm), ensuring sports performance and resistance of the surface. To be applied in situ.

Linofinish Kit
(5 liters Primer Can + 2 cans of 5 liters of Linofinish to be mixed with the Linofinish hardener)
Article code: 1551083

GREENLAY® INSTALLATION KIT

Specifically adapted to ensure the durability of GreenLay® installation.

GreenLay® glue: Used to form a cove where floor coverings are continued up the wall.
2 components (A+B), 1 pot of 5kg each

Component	Article Code
A	1551057
B	1551058

Tarkotape: Used to reinforce junction between 2 rolls.
1 box of 12 tapes (15cm x 33lm)
Article code: 1551085

TABLE TENNIS



Double-tape unroller enabling the application of double-tape and the assembly of the 2 vinyl rolls of table tennis temporary solution.

Article code: 1430002

ACCESSORIES FOR SPORTS FLOORINGS

SPORTS FINISHING ACCESSORIES

WOOD VENTILATED SKIRTINGS



Specific wood varnished skirting with spaces made to allow cross ventilation of the wood flooring or sub-construction. For S'Match-it and Lumaflex ranges.

	Wood Ventiladed Skirting	
	(standard)	(wide)
Oak varnished	1551067	1551068
Beech varnished	1551065	1551066
Maple varnished	1551069	1551070

Wood Ventiladed Skirting (standard)

1 box of 5 units=11.75 lm
Thickness: 22mm
Width: 65 mm
Length: 2350mm

Wood Ventiladed Skirting (wide)

1 box of 4 units=9.40 lm
Thickness: 27 mm
Width: 84 mm
Length: 2350mm

TRAPDOORS

Trapdoors used to ensure the positioning of goals in sports halls. Filled with wood (S'Match-it range) or vinyl/linoleum (Lumaflex range) for perfect colour matching.

TRAPDOORS FOR WOOD RANGE



	Diameter 135mm (net opening 90mm)	Diameter 220mm (net opening 170mm)
	Oak	1551028
Beech	1551030	1551031

TRAPDOORS FOR LUMAFLEX RANGE



	Diameter 135mm (net opening 90mm)	Diameter 220mm (net opening 170mm)
	"bare" trapdoor to be filled with Linosport or Omnisports	1551034

HARD FLOORING FINISHING ACCESSORIES

TRANSITION SET FOR WOOD AND LUMAFLEX



Facilitates access to wood or combined sports systems (up to 40mm high). Made of exotic wood for extreme resistance.

40mm x 2700mm
5.4lm per bundle
Article code: 1551072

ADJUSTABLE RAMP



Aluminium adaptable ramp even for high thickness floorings. Conforms to accessibility standards and regulations.

140 x 960 mm
Order per unit
Max Height 100mm
Article code: 1551074



ACCESSORIES FOR SPORTS FLOORINGS

HARD FLOORING ■ INSTALLATION ACCESSORIES

■ WOOD (TARGLUE / TARGUN)



Targlue (PU mastic glue) and Targun have been specifically designed for the installation of Multiflex M. Applied with Targun, Targlue fixes the Tarflex subconstruction with the 14mm multi-layer.



Targlue

1 cardboard of 20 bags of 600ml each
1 cardboard = 200sqm
Article code: 1551006

Targun

order per unit
Article code: 1551007

■ LUMAFLEX INSTALLATION KIT

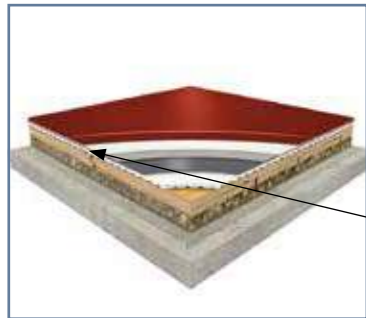

All inclusive installation kit for Lumaflex for a quick and easy installation. Nozzle specifically engineered for Lumaflex profile.

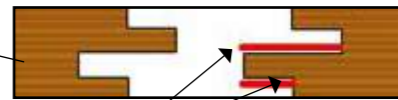

Glue

LUMAGLUE

5kg bucket
Article code: 1551075

Glueing system

Article code: 1551077 (special no stock)

Nozzle

Article code: 1551076



Lumaflex Glue
Delivery System
+ Lumaflex nozzle



PROTECTIONS ■ INSTALLATION ACCESSORIES

■ UNROLLER FOR TOUCHDOWN



Unroller designed to facilitate the installation of Touchdown rolls. Made up of 2 supporting frameworks fitted with castors and one mandrel.



(Special no stock)

Support article code: 1562001

Roller article code: 1562002

■ TROLLEY FOR PROTECTILES



Trolley made of 4 articulated wheels with rubber strips and 2 brakes. Capacity: 100 ProtecTiles



Article code: 1568001